



SLAMP:
THE LEADING LIGHT

THE SOUND OF LIGHT
COMPENDIUM 2021



THE SOUND OF LIGHT

COMPENDIUM 2021

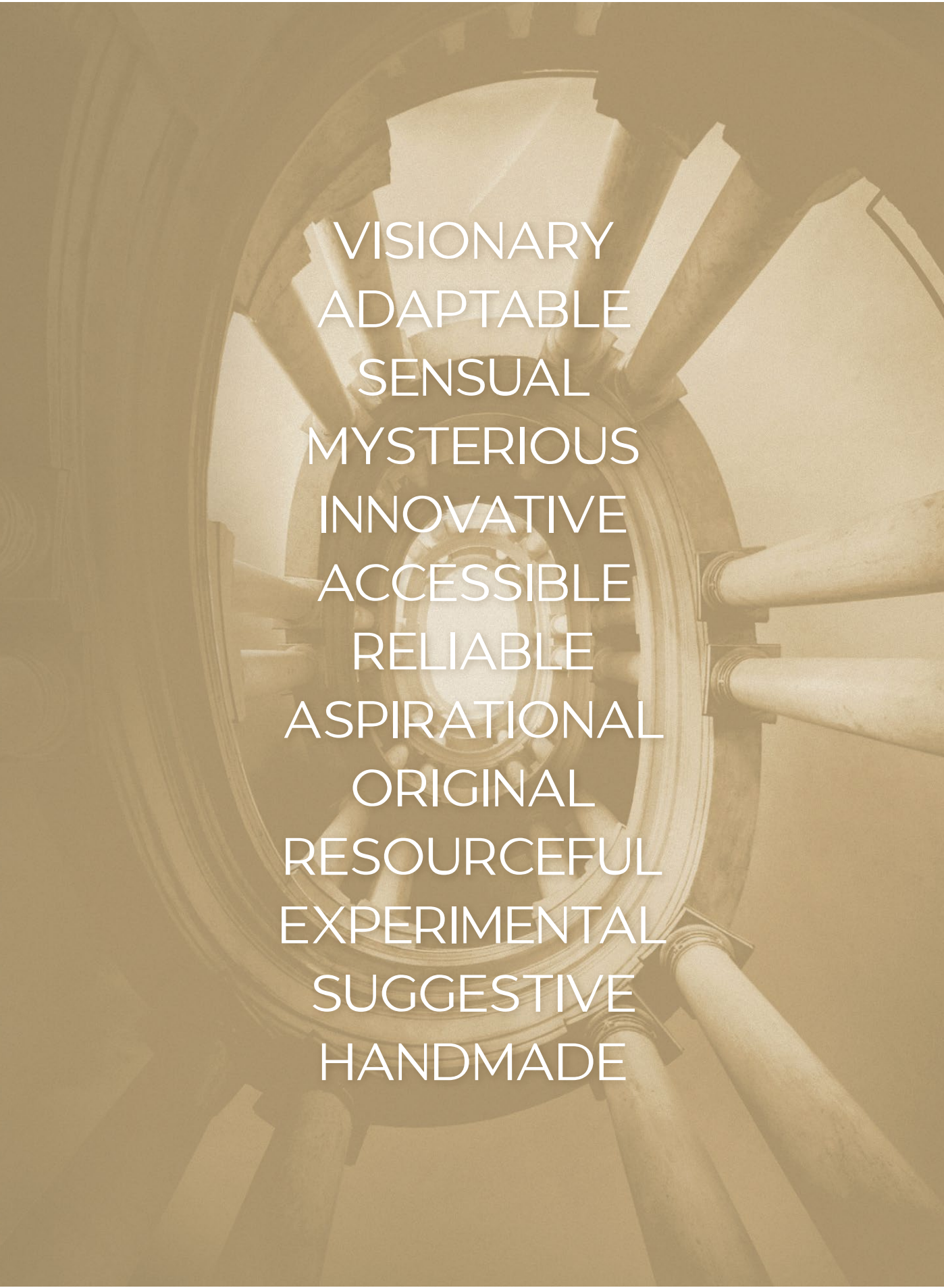

VISIONARY
ADAPTABLE
SENSUAL
MYSTERIOUS
INNOVATIVE
ACCESSIBLE
RELIABLE
ASPIRATIONAL
ORIGINAL
RESOURCEFUL
EXPERIMENTAL
SUGGESTIVE
HANDMADE

the Sound of light

The whole existence of man and objects, matter, life force...all owing their physical being to frequencies. No experience exists without having been attracted by frequency; emotions, even love and hate, are harmoniously tied to a specific vibration. Nature has taught us that things originate in relation to a frequency's mathematical structure: the Flower of Life's geometry and the Golden Ratio are evidence of this. Sacred Geometry, the foundation of universal balance, inspires us to infuse the same harmony in our lamps. It resonates within us, transforming, like thoughts that morph into words, into unique objects. I see Slamp as a large, beautiful orchestra, manifesting its own harmonies. The materialised sounds to be heard and seen within this catalogue are those produced by the exceptional people who are part of it, the colours that surround them, the systems that vivify them, and their founding values. Slamp transforms these frequencies into objects through an alchemic process combining sensitivity and technique. These objects blend light and shadow, polar energies that co-penetrate a harmonic frequency, giving life to illumination. These glowing melodies, shapes and colours intrinsic exclusively to Slamp, create unique vibrations, echoing emotion and sensations within us.

Tutta l'esistenza degli uomini e delle cose, la materia, la vita...tutto deve il suo essere al mondo fisico della frequenza. Non si può avere un'esperienza senza averla attratta con la frequenza: ogni emozione, incluso amore e odio, si armonizzano in una specifica vibrazione. La Natura ci ha insegnato che dal rapporto matematico di alcune frequenze origina la vita, e la geometria del "Fiore della Vita" o la proporzione "Aurea" ne sono una dimostrazione. La geometria sacra, principio fondante dell'armonia dell'universo, ci ispira costantemente a trovare quell'equilibrio nelle nostre lampade. Ci risuona nel cuore e viene trasformata, proprio come i pensieri vengono trasformati in parole, in oggetti unici. È per questo che vedo Slamp come una bellissima, grande orchestra, in grado di materializzare le proprie armonie. I suoni materializzati che vedrete/sentirete nel catalogo sono i suoni delle meravigliose persone che ne fanno parte, dei colori che la circondano, dei sistemi che la animano, dei valori che l'hanno fondata. Attraverso tecnica e sensibilità, Slamp trasforma, in un processo alchemico, queste frequenze in oggetti. Oggetti che fondono insieme la capacità di armonizzare luci e ombre, un sistema dualistico di forze polari che solo compenetrandosi in una frequenza armonica dà origine alla nostra magia di luce. Questa melodia - concretizzata nelle luci, le forme e i colori irripetibili di Slamp - crea vibrazioni uniche, che risuonano in noi sotto forma di emozioni e sensazioni.

Luca Mazza
Slamp Creative Director

EDITOR

Roberto Ziliani

CREATIVE DIRECTION

Luca Mazza

MARKETING & COMMUNICATION

Erika Martino

GRAPHIC ADVISOR

Noemi Patriarca

PHOTOS

Massimo Listri

Thomas Pagani

Ezio Gosti

Pedro Sadio

Lorenzo Sechi

PRE-PRINTED & PRINTED

Euroteam

Green Advanced Printing

This Catalogue has been printed using plant-based ink.

Questo Catalogo è stampato con inchiostri a base vegetale.

printed in December 2020

SLAMP S.p.A.

Via Vaccareccia 12/14

00071 - Pomezia, Roma, Italy

tel. +39 06 916 23 91, fax +39 06 916 23 933

info@slamp.com - www.slamp.com

ALPHABETICAL INDEX

ACCORDÉON	30	HUGO ARCHITECTURAL	140
ARIA	46	IDEA	258
ARIA XL	50	KALATOS	36
ATLANTE	170	LA BELLE ÉTOILE	94
ATMOSFERA	40	LA LOLLO	88
AURORA	236	LA LOLLONA	84
AVIA	52	LA TRAVIATA	130
AVIA EDITION	56	LA VIE	188
BACH	298	LAFLEUR	252
BIOS	238	LAS PALMAS	312
CACTUS	174	LILLIBET	184
CEREMONY	150	LIZA	154
CHANTAL	68	LUIS	178
CHARLOTTE	60	MEDUSA	158
CLIZIA	70	MIDA	200
CORDOBA	120	MILLE BOLLE	168
DAFNE	240	MIRAGE	368
DIAMOND	306	MOON	270
DIMPLE	164	NUVEM	14
DRUSA	152	OVERLAY	286
ECSTACITY	428	SUPERMORGANA	156
ÉTOILE	98	THE LIGHTNING ARCHIVES	408
FABULA	148	VELI	102
FIGURELLA	180	VENTI	244
FLORA	136	WOODY	166
GEMMY	160		
GINETTA	172		
GOCCIA	176		
HALF CHARLOTTE	66		
HANAMI	124		
HUGO	144		

SUSPENSION LAMP INDEX



ACCORDÉON
p.30

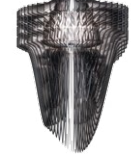

ARIA BLACK FADE
p.50



ARIA GOLD
p.46

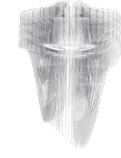

ARIA TRANSPARENT
p.48



ATLANTE
p.170

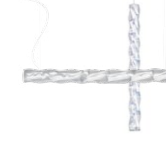

HUGO
p.144



HUGO ARCHITECTURAL
p.140



KALATOS
p.36



LA BELLE ÉTOILE
p.94



LA LOLLO
p.88



ATMOSFERA
p.40



AVIA
p.52



AVIA EDITION
p.56



CACTUS
p.174



CEREMONY
p.150



LA LOLLONA
p.84



LA TRAVIATA
p.130



LILLIBET
p.184



LIZA
p.154



LUIS
p.178



CHANTAL
p.68



CHARLOTTE GLOBE
p.60



CLIZIA
p.70



CORDOBA
p.120



DIMPLE
p.164



MEDUSA
p.158



MILLE BOLLE
p.168



NUVEM
p.14



SUPERMORGANA
p.156



VELI
p.106



DRUSA
p.152



ÉTOILE
p.98



FABULA
p.148



FIGORELLA
p.180



FLORA
p.136

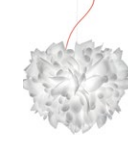

VELI FOLIAGE
p.102



VELI MINI
p.108



VELI 7
p.116



WOODY
p.166



GEMMY
p.160



GINETTA
p.172



GOCCIA
p.176



HANAMI
p.124



HALF-CHARLOTTE
p.66

SUSPENSION LAMP INDEX

CEILING LAMP INDEX



AURORA
p.236



BIOS
p.238



CLIZIA
p.218



DAFNE
p.240



DRUSA
p.232



ÉTOILE
p.230



FABULA
p.234



HANAMI
p.226



KALATOS
p.194



LA BELLE ÉTOILE
p.228



LA VIE
p.188



MIDA
p.200



VELI
p.208

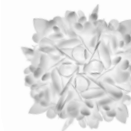

VELI FOLIAGE
p.206



VENTI
p.244

TABLE LAMP INDEX



ACCORDÉON
p.246



ATMOSFERA
p.266



ATMOSFERA FRINGE
p.262



BACH
p.298



BIOS
p.316



CACTUS
p.300



CLIZIA BATTERY
p.272



CLIZIA
p.278



DAFNE
p.314



DIAMOND
p.306



FIORELLINA
p.294



GEMMY
p.302



IDEA
p.258



LAFLEUR
p.252



LAS PALMAS
p.312



LIZA
p.280



MILLE BOLLE
p.310



MOON
p.270



OVERLAY
p.286



VELI
p.292



VELI FOLIAGE
p.290



VENTI
p.308

WALL LAMP INDEX

FLOOR LAMP INDEX



BIOS
p.372



CHARLOTTE
p.332



CLIZIA
p.346



CLIZIA APPLIQUE
p.347



DAFNE
p.376



DRUSA
p.366



ÉTOILE
p.364



FABULA
p.380



FIORELLA MINI
p.382



HANAMI
p.344



IDEA
p.326



LA BELLE ÉTOILE
p.362



LA LOLLO
p.334



LA VIE
p.338



LILLIBET
p.378



MEDUSA
p.384



MIDA
p.318



MIDA APPLIQUE
p.322



MILLE BOLLE
p.370



MIRAGE
p.368

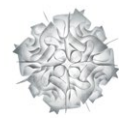

VELI
p.354

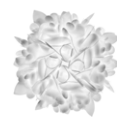

VELI FOLIAGE
p.352



VENTI
p.374



ATLANTE
p.442



BACH
p.412



BIOS
p.434



CACTUS
p.420



CHARLOTTE
p.392



CLIZIA
p.416



DAFNE
p.432



DIAMOND
p.440



ECSTACITY
p.428



FIORELLA
p.430



FLORA
p.398



GEMMY
p.426



HUGO
p.386



LA LOLLO
p.402



LAS PALMAS
p.424



LIZA
p.418



MILLE BOLLE
p.438



THE LIGHTNING ARCHIVES
p.408



VENTI
p.436

SLAMP

THE LEADING LIGHT

unveil the
unique —

Every Stamp lamp is unique. Unique because it does not originate from a 3D file; the creative process requires a designer to get their hands dirty as they cut, "sew", and sculpt materials, applying years of concrete and studious research and development. Unique because the ladies who "tailor light" don their white gloves and proudly bring a poetically original piece to life. Unique because a lamp is the pure expression of the person who selected it, reflecting their aesthetic identity, those who leave light as the only vibration on a silent evening, unwittingly reigniting the energy of an artistic creation with a single click.

Ogni lampada Stamp è unica. Unica perché frutto di un processo creativo che non origina da un file 3d, ma che richiede al progettista la volontà di "sporcarsi le mani", tagliando, cucendo e trattando materiali e valori sedimentati in anni di studio, ricerca e innovazione. Unica perché allestita in un Atelier dove ogni giorno le Sarte della Luce, indossati i loro guanti bianchi, sono orgogliose di mettere al mondo un capo che si distingue per poetica e originalità. Unica perché espressione di chi ama raccontare la propria identità attraverso gli oggetti che lo circondano; di chi lascia che la silenziosa presenza della luce si trasformi nella migliore colonna sonora di una sera; di chi ogni giorno con un click sull'interruttore riaccende, inconsapevolmente, tutta l'energia della creazione.



©Pedro Sadio

handmade in Italy SINCE 1994

Slamp has been at the forefront of creating innovative, original, eclectic, and contemporary lamps since 1994, taking current inspiration from the natural world, architectural and sartorial genius, and artistic trends. Slamp creates suggestive, luminous, and versatile objects using the latest generation of materials, manually moulded into elements that combined together, make up a luxurious landscape. The use of exclusive, lightweight and resistant technopolymers gives a unique and recognizable touch to every lamp, allowing it to be sculpted into three dimensional shapes, decorations and effects that would be impossible using any other material. Much like any maison dedicated to haute couture, Slamp lamps undergo a precise ritual that transforms a sheet of technopolymer material into an exceptionally decorative, three dimensional shape through cold cutting and handcrafting.

Nel panorama dell'illuminazione decorativa di design, Slamp è punto di riferimento per chiunque desideri un oggetto ricercato, originale, esclusivo e innovativo. Catturando gli stimoli più attuali, attingendo al mondo naturale, ai virtuosismi architettonici e sartoriali, alle tendenze artistiche, dal 1994 Slamp crea oggetti luminosi, suggestivi e versatili grazie all'impiego di materiali di nuova generazione e a una speciale abilità manuale nell'assemblare elementi che si compongono dando vita a un lussureggiante panorama figurativo. Unicità e riconoscibilità di ogni lampada passano attraverso l'uso di tecnopolimeri esclusivi, leggeri, nobili e infrangibili che permettono di realizzare forme, decori ed effetti altrimenti impossibili con altri materiali. Come in una maison di haute couture, la creazione di una lampada Slamp passa attraverso una precisa ritualità che trasforma, tramite un sistema di lavorazioni a freddo, incastri e piegature eseguite a mano, un foglio piano di tecnopolimero in un volume tridimensionale altamente decorativo.

Nuvem

MODULAR SYSTEM
DESIGN BY MIGUEL ARRUDA

technical details p. 475

SUSPENSION



Single module size /
Dimensioni modulo singolo:
102 x 94 x h. 6 cm
39-3/4 x 36-1/2 x h 2-1/4"

Modules of 1 sq. meter can be
joined in infinite combinations;
bidirectional illumination.

Moduli da 1 mq con luce
bidirezionale componibili
all'infinito.

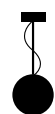

SUSPENSION



WALL LAMP



CEILING LAMP



TABLE LAMP



FLOOR LAMP

ENDLESS SHAPES, ENDLESS BEGINNINGS

"We didn't create a lamp, we created a ceiling." Architect Miguel Arruda created a system of 1 metre hexagonal components that can be combined infinitely in diverse luminous installations.

"Non abbiamo fatto una lampada, abbiamo fatto un soffitto". Con queste parole l'Arch. Miguel Arruda introduce il suo lavoro per Slamp: un sistema componibile di moduli da 1 mq ciascuno (di sezione esagonale) che si può comporre all'infinito creando differenti scenari luminosi.



PLAY VIDEO





The 1 sqm modules have been handcrafted, really tailored, by Slamp's artisans; each can be connected thanks to a quick, intuitive, easy to install system that uses simple tabs.

I moduli da 1 mq sono pre-allestiti a mano dalle Sarte della Luce di Slamp e si possono collegare l'uno all'altro tramite dei semplici bottoni, rendendo l'installazione rapida e intuitiva.

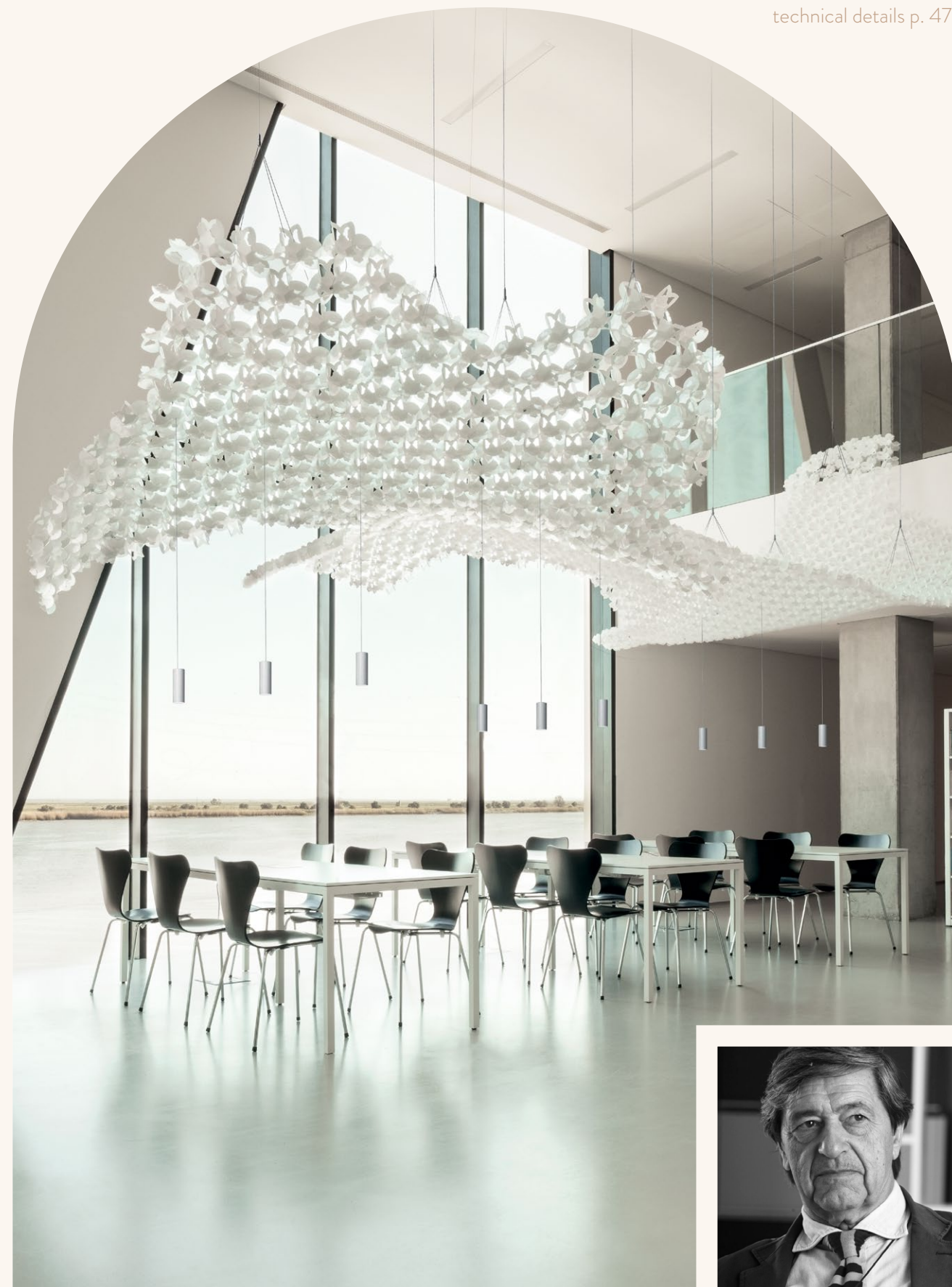

MIGUEL ARRUDA

INFINITE EXTENSIONS IN EVERY DIRECTION

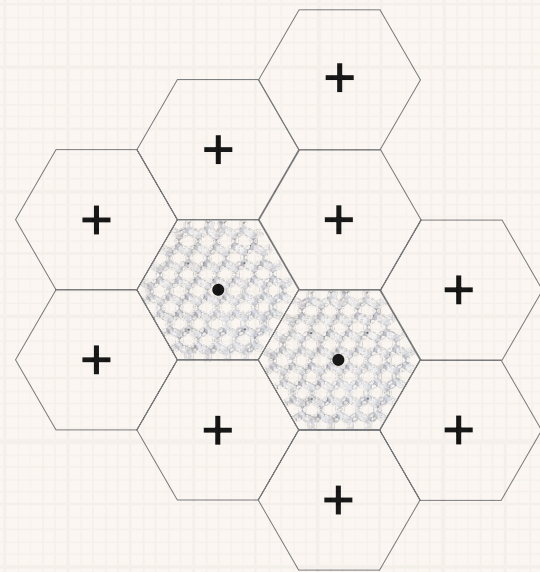

The meter-long hexagonal elements are easily connected by hand using a series of interlocking tabs that allow for limitless omnidirectional installation. The modules facilitate the adaptable and mutable personalization of private and contract spaces, adding a strong artistic note to each..

Gli elementi esagonali di un metro quadro, tramite un semplicissimo sistema di connessioni eseguibili a mano, si uniscono gli uni agli altri espandendosi in ogni direzione, per personalizzare gli ambienti con design sempre diversi e aggiungere una forte connotazione artistica ad abitazioni private e strutture ricettive.

PERSONALIZED SPOTLIGHTS

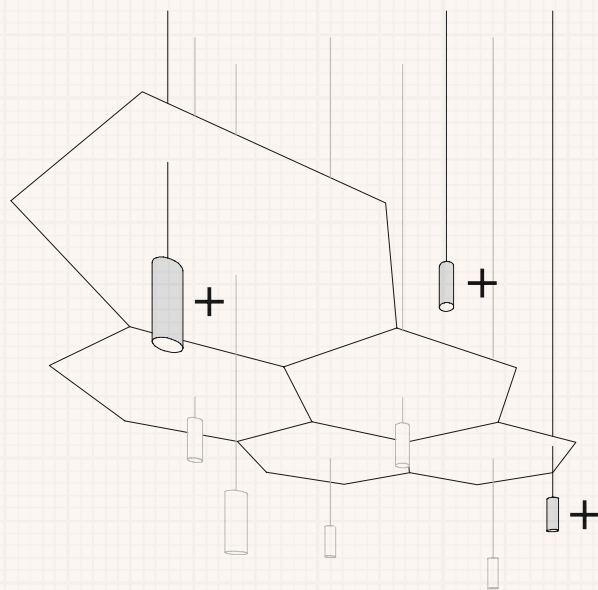

Nuvm's lighting system is a series of bidirectional spotlights (one per square meter) that can be positioned above or below (threaded through the modules' openings). Additional spotlights can be purchased separately for compositions that require amplified illumination.

Il sistema luminoso di Nuvm è composto da una serie di faretti con emissione bidirezionale (uno per ogni mq) che possono essere calati al di sotto del modulo decorativo, passando tramite i fori della composizione, o sollevato al di sopra della struttura. In presenza di particolari necessità compositive, eventuali faretti aggiuntivi possono essere acquistati separatamente.

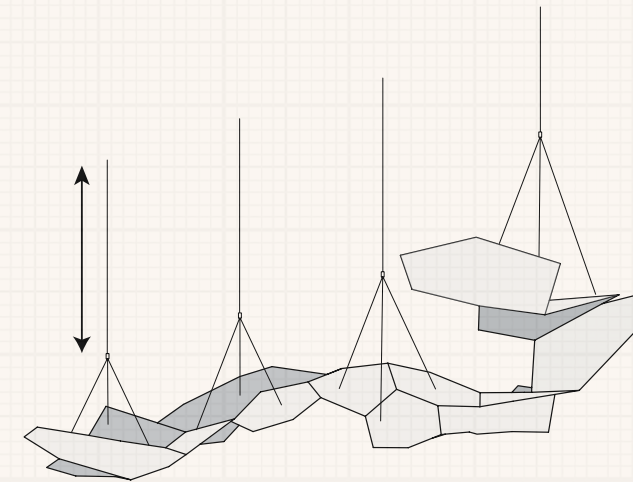

ADJUSTABLE HEIGHT

Nuvm's height can be adjusted using the 6 meter cable, and once suspended, the design can be "moulded" using the push and pull system located directly beneath each module. The lamp collapses or tenses when the wires are pushed (released) or pulled, giving the ceiling a fluctuating feeling.

Oltre alla regolazione dei cavi fino a 6 metri, Nuvm dà la possibilità di modulare il design dell'oggetto, una volta sospeso, tramite il sistema "push and pull" posto direttamente al di sotto del modulo decorativo. Tirando o rilasciando i singoli cavi, la lampada si anima - collassando o stirandosi - per dare forma a un "soffitto" fluttuante.

FROM A LAMP TO VERTICAL DECORATION

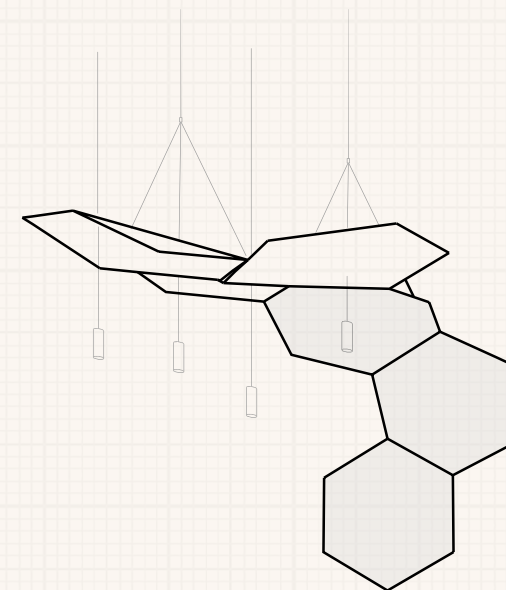

Weightless and free...just like a cloud. Nuvm goes beyond traditional illumination, with agile anatomy that allows it to transform the architectural elements of a space, running across the ceiling and moving down the walls, creating an infinite sky.

Leggera e libera come una nuvola, Nuvm va oltre la semplice illuminazione tradizionale: l'agilità della sua anatomia le permette di enfatizzare gli elementi architettonici trasformandosi da "soffitto" a decoro, calando sulle pareti per eliminare ogni confine tra cielo e terra della stanza

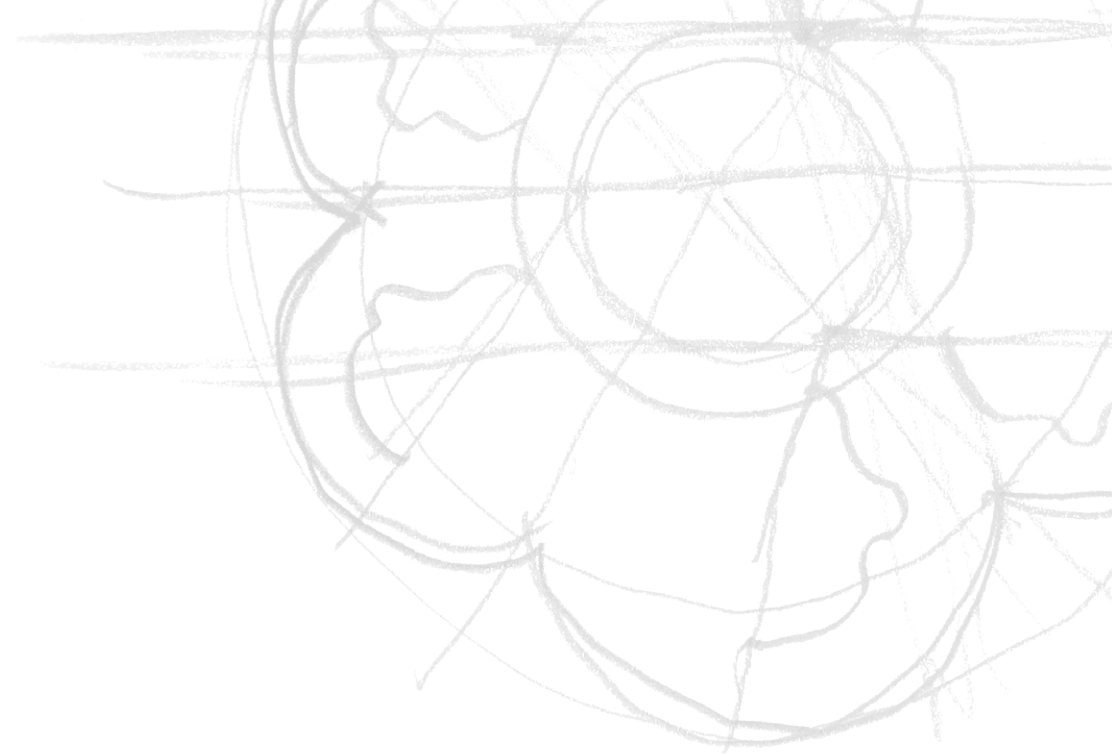

miguel — arruda

NOT A LAMP, BUT A GLOWING CEILING

Miguel's studio Miguel Arruda Arquitectos Asociados concentrates on sculpture, industrial design, and architecture. Creating architectural spaces is not an act of genius on the part of the designer, but the challenge of creating a pleasurable place to exist in, defining areas that will host rituals and harmonious freedom. The desire to transfer the freedom of expression is encapsulated in Nuvem, not simply a lamp, but a luminous ceiling, a flexible system that can be modeled to every space and its inhabitants. Nuvem is a design tool that grants absolute liberty, adding a dominating artistic feel to private and public places.

Lo studio di Miguel Arruda Arquitectos Asociados si concentra sulla scultura, il design industriale e l'architettura. La creazione degli spazi architettonici non è esercizio di maestria del progettista ma ha come obiettivo il piacere di chi lo vive ogni giorno. Dare forma ad un luogo che sarà dimora di riti e di libertà anonime. Con questa voglia di "donare" libertà di espressione nasce Nuvem, non solo una lampada ma un soffitto luminoso, un sistema adattabile e modellabile a seconda delle esigenze dello spazio in cui viene allestito e delle persone che lo vivranno. Uno strumento che nelle mani di altri progettisti permette massima libertà e aggiunge una forte connotazione artistica ad abitazioni private e strutture ricettive.



Composition with 5 modules and 3 bidirectional spotlights, private house, Apulia, Italy.
Esempio di composizione con 5 moduli e 3 spotlight bidirezionali, Villa privata in Puglia.



Composition with 11 modules and 5 bidirectional spotlights, private house, Apulia, Italy.
Esempio di composizione con 11 moduli e 5 spotlight bidirezionali, Villa privata in Puglia.



Installation in the
Vila Franca de Xira
Municipal Library, Portugal

Installazione presso
la Biblioteca Municipale
di Vila Franca de Xira
in Portogallo.

THE FREEDOM TO PERSONALISE INSTALLATIONS

Nuvm is a system that knows no bounds, whether composed of modules accompanied by bi-directional spotlights or unlit, individual hexagons. A single ceiling rose can power up to 6 units, and extra ceiling/wall (unidirectional) or bidirectional spots can be added as desired.

In base alle necessità del progetto, il sistema Nuvm si può configurare usando sia moduli completi di faretto bidirezionale sia moduli singoli senza sorgente luminosa. Con un unico rosone si possono collegare elettricamente fino a 6 fonti luminose. Inoltre possono essere integrati faretto extra sia bidirezionali sospesi che unidirezionali con attacco a soffitto/muro.



ADI Design Museum - Milan, Italy.



Private house in Umbria, Italy.

Accordéon

DESIGN BY MARC SADLER

technical details p. 446

SUSPENSION



- 
 SUSPENSION
- 
 WALL LAMP
- 
 CEILING LAMP
- 
 TABLE LAMP
 p.246
- 
 FLOOR LAMP

Accordéon Gold

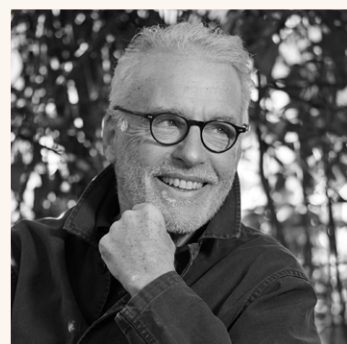

MARC SADLER

Accordéon Silver

WHEN SOMETHING TECHNICAL IS WHOLLY SARTORIAL

When the culture of hand-tailoring meets the continuous innovation of unique materials, the possibilities are limitless. Accordéon is hand folded, formed, and draped like material to clothe the illumination beneath.

Quando la cultura del fatto a mano incontra un'incessante ricerca sui materiali, le possibilità sono infinite. Accordéon è realizzata scaldando il materiale unico di Slamp e drappeggiandolo a mano come fosse un tessuto.

Accordéon White detail
 Dettaglio Accordéon White

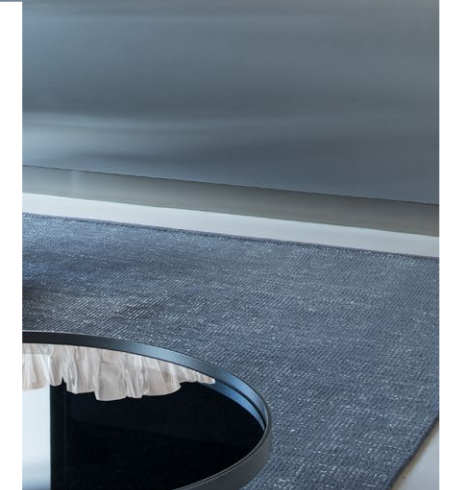

PLAY VIDEO



Size / Dimensione:
 Ø 57 cm x h. 20 cm
 Ø 22 1/4" x h. 7 3/4"

Available with a silky white,
 gold or silver core ring.

Disponibile con anello centrale
 in 3 finiture: silky white,
 gold e silver.

AT FIRST SIGHT, TANGIBLY TACTILE

At first sight, it seems soft to the touch, almost silky, but the ring is made of unbreakable materials. The LED illuminates uniformly through prismatic Lentiflex®.

Ciò che a una prima occhiata appare morbido e setoso, è in realtà un anello materico, consistente e infrangibile. La luce dei LED si diffonde in modo uniforme grazie all'effetto prismatico del Lentiflex®.



Kalatos

DESIGN BY ELISA GIOVANNONI

technical details p. 468

SUSPENSION



Kalatos Black/Gold



SUSPENSION



WALL LAMP



CEILING LAMP
p.194



TABLE LAMP



FLOOR LAMP



**WEIGHTLESS FEMININE ESSENCE,
PRIMITIVE DOMESTIC CRAFT**

Kalatos is clearly inspired by the art of weaving baskets and cane sacks, a traditional domestic art that has been a part of humankind since prehistoric times. The collection is a high-tech take on this artisan craft, using Slamp's unique technopolymers; there are suspension and ceiling version.

Il design di Kalatos è di chiara ispirazione all'arte dell'intreccio, espressione dell'artigianato artistico tradizionale che l'uomo porta con sé da quando, nella preistoria, intrecciava fibre vegetali per dar vita a cesti e canestri. Rivisitata in chiave high-tech, dato l'utilizzo dei tecnopolimeri di Slamp, la collezione si compone di una versione a sospensione e una plafoniera.



Kalatos Prisma, bottom view



Size /Dimensioni:
Ø63 x h. 30 cm
Ø24-1/2" x h. 11-3/4"

Atmosfera

DESIGN BY LORENZA BOZZOLI

technical details p. 447



TRENDS ARE FLEETING, TASTE IS INTRINSIC

Atmosfera is on the edge of fashion and design, a glam, retro collection that mixes a glowing, hand brushed sphere and a warm, saturated metallic base that shines thanks to an aluminum bath in a hyperbaric chamber, just one of the many treatments Slamp applies to their unique technopolymers.

Al confine tra moda e design nasce Atmosfera, la collezione dal look glam retrò realizzata combinando una sfera spazzolata a mano - che permette la fuoriuscita della luce omogenea e rotonda - e un corpo metallizzato tramite evaporizzazione di alluminio in camera iperbarica - una lavorazione esclusiva per i tecnopolimeri unici di Slamp.



LORENZA BOZZOLI

Atmosfera Suspension Pewter - Atmosfera Table Gold Small and Medium





A cascade of Atmosfera Gold in the centre of the NOHOW headquarter's spiral staircase. Space owned by fashion influencer Mariano di Vaio.

Una cascata di Atmosfera Gold al centro di una scala a spirale, presso l'headquarter di NOHOW, azienda del fashion influencer Mariano di Vaio

DOUBLE LAYERS OF UNIQUE MATERIALS REVEAL THE GLOW BENEATH

There are two light sources, one in the spherical diffuser, and the other in the metallised base.

The decorative polkadot punches are a result of laying two sheets of Goldflex® o Poverflex® flexible technopolymers that have been shaped by hand.

L'emissione della luce avviene da due fonti luminose: una nel diffusore sferico e una nel corpo metallizzato traforato con un effetto decorativo a pois ottenuto tramite la sovrapposizione di 2 strati di Goldflex® o Poverflex®, tecnopolimeri flessibili e modellati a mano.

Size /Dimensioni:
 Ø30 x h 44,5cm
 Ø11 3/4" x h. 17 1/4"

technical details p. 447





© Steve Double

DAME Zaha — hadid

LIGHT YIELDS ENDLESS OPPORTUNITIES,
DEFINING THE WORLD AROUND US

"I remember my parents ordering some new furniture for our home, and for my room there was an asymmetric mirror. I was thrilled by this mirror; it started my love for design. I was 7 years old. As a student in London in the 1970's, I was fascinated by Malevich's experimentation with urbanism, and felt compelled to put forth my own ideas based on innovation and progress, proposing new architectural solutions". Zaha taught us that design objects should inherently suggest their purpose without forcing one's intuition. In working with light, one must remember that it changes the colour and texture of surrounding objects, as well as their spatial perception. Light's profound significance can be identified in how it generates infinite possibilities of defining the world around us.

"Ricordo quando i miei genitori ordinarono dei nuovi arredi per la nostra casa, per la mia stanza era stato previsto uno specchio dalle linee asimmetriche: mi ha entusiasmato davvero, ed è da lì che è iniziato il mio amore per il design. Avevo 7 anni. Nel 1970, studiando a Londra e guardando le sperimentazioni urbanistiche di Malevich, mi sono sentita spronata a proporre le mie idee per nuove soluzioni architettoniche basate su progresso e innovazione". Zaha ci ha insegnato che un buon oggetto di design dovrebbe suggerire naturalmente la sua funzione, senza richiedere sforzi intuitivi. Nel lavorare con la luce, poi, bisogna tener conto che essa modifica gli oggetti stessi, il loro colore, la loro texture, la percezione che di essi si ha nello spazio. È in questa funzione di generare infinite opportunità di definire il mondo intorno a noi che la luce trova il suo più profondo significato

Aria GOLD

DESIGN BY ZAHA HADID

technical details p. 446

SUSPENSION



ZAHA HADID

Zaha Hadid's luminous architecture is visionary, fluid and dynamic, infusing the revolutionary and iconic semantics of the celebrated architect into domestic and public interiors. The arms radiating around a luminous source are resistant yet easily connected thanks to simple mounting system.

Visionarie, fluide, dinamiche: le architetture luminose firmate da Zaha Hadid trasferiscono la rivoluzionaria e iconica semantica dell'archistar all'interno di ambienti domestici e recettivi. Le braccia avvolgono la sorgente luminosa tramite un semplice sistema di aggancio resistente ma facile da eseguire.



PLAY VIDEO



The Gold version has Cristalflex® arms that have been metallised through vapourisation in a hyperbaric chamber, examined for uniformity, then cut using a numerical system before being wrapped in protective film and placed within the box, making customer assembly rapid, intuitive, and enjoyable.

Nella versione Gold, le lance radiali in Cristalflex® vengono prima metallizzate tramite evaporizzazione in camera iperbarica, esaminate per eliminare eventuali scarti, poi tagliate tramite un sistema a controllo numerico e infine inserite nel box, intervallate da uno strato protettivo, al fine di rendere l'installazione da parte del cliente intuitiva, veloce e piacevole.



Aria

TRANSPARENT
DESIGN BY ZAHA HADID



Hadid's masterpiece consist of 50 layers, each diverse from the others, radiating around a voluminous LED source.
Il masterpiece di Zaha Hadid si compone di una struttura radiale composta da 50 layers diversi l'uno dall'altro che avvolgono la sorgente luminosa a LED creando un volume tridimensionale.

Aria Transparent at the De Blauwe Dame Restaurant, Holland; In the middle an installation in the Borgo San Felice winery, Tuscany, Italy. Left SPC office project, Jakarta, Indonesia.

Aria Trasparent presso il ristorante De Blauwe Dame Restaurant in Olanda; Al centro: installazione presso la cantina Borgo San Felice in Toscana. A destra: SPC office, Jakarta, Indonesia.

Aria

BLACK FADE
DESIGN BY ZAHA HADID

technical details p. 447



VISIONARY, FLUID AND DYNAMIC ARCHITECTURE

Zaha Hadid's visionary design has shaped international contemporary architecture; her DNA has been distilled in a dramatic and regal luminous sculpture. The arms surrounding the light source have black, shaded borders, giving their design a dense, almost ethereal feel.

Il DNA di Zaha Hadid, il cui disegno visionario ha segnato la storia dell'architettura contemporanea internazionale, è racchiuso in una scultura luminosa maestosa e scenografica. Il design delle lance che avvolgono la sorgente luminosa è accentuato dalla sfumatura nera di contorno che restituisce un'immagine densa e al contempo eterea.

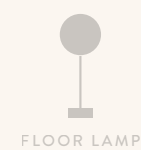
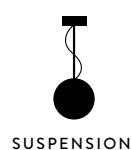

Avia

DESIGN BY ZAHA HADID

technical details p. 449

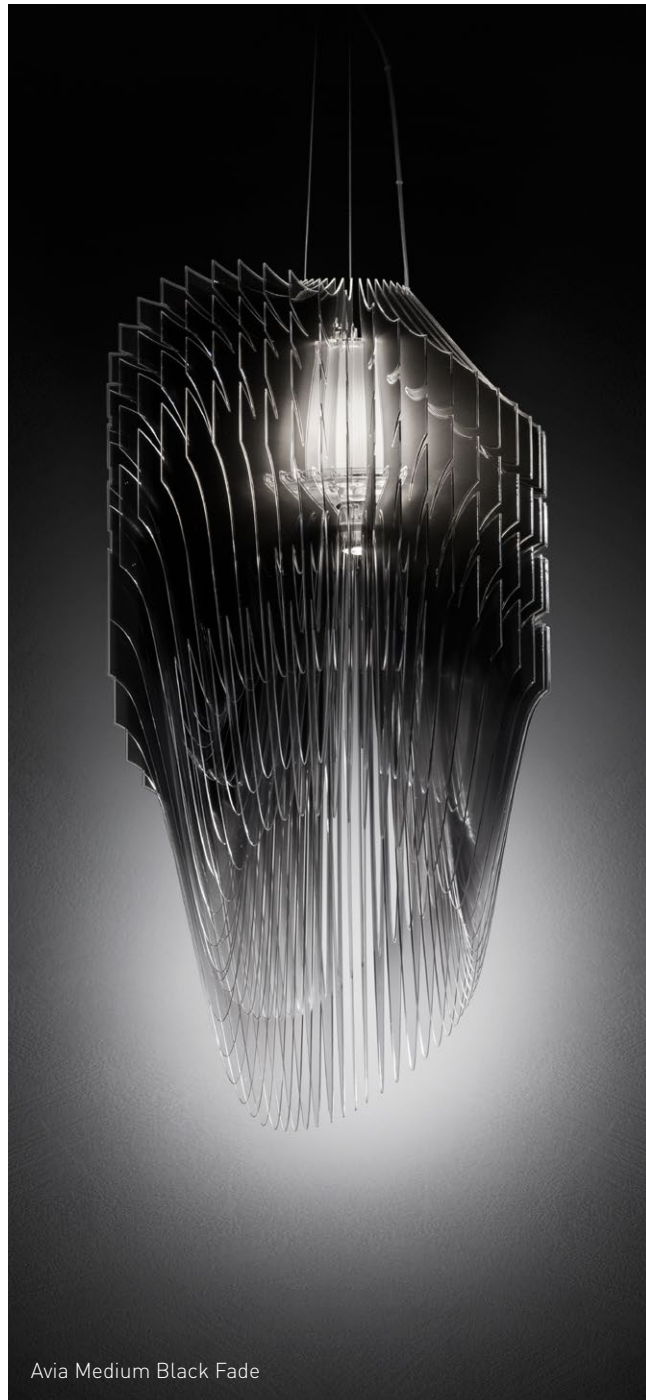

Avia Medium Black Fade



Avia Medium White Fade



SUSPENSION



WALL LAMP



CEILING LAMP



TABLE LAMP



FLOOR LAMP



Avia Large Black Fade



THE GRANDEUR OF LARGE SCALE BUILDINGS DISTILLED INTO A LAMP

Zaha Hadid has left an innovative and visionary mark not only on large scale buildings and museums, but on Avia, a suspension fit for intimate settings. The radial structure made of Cristalflex® starts with slight black or white shading that slowly fades downwards to transparent edges.

Il visionario e innovativo segno di Zaha Hadid non è più solo appannaggio delle grandi opere architettoniche e degli edifici museali più famosi al mondo: con la collezione Avia esso diventa un privilegio quotidiano per chi la inserisce nella dimensione intima del proprio spazio di vita. La struttura radiale in Cristalflex® è caratterizzata da una morbida sfumatura che cresce passando dalla totale trasparenza, in basso, al bianco o nero che avvolge la fonte luminosa in alto.

Available in 4 dimensions starting from the Small Ø45 cm x h. 85 cm to XL version Ø75 cm x h. 140 cm.

Disponibile in 4 dimensioni dalla taglia Small con Ø45 cm x h. 85 cm alla XL con Ø75 cm x h. 140 cm



Avia Large White Fade

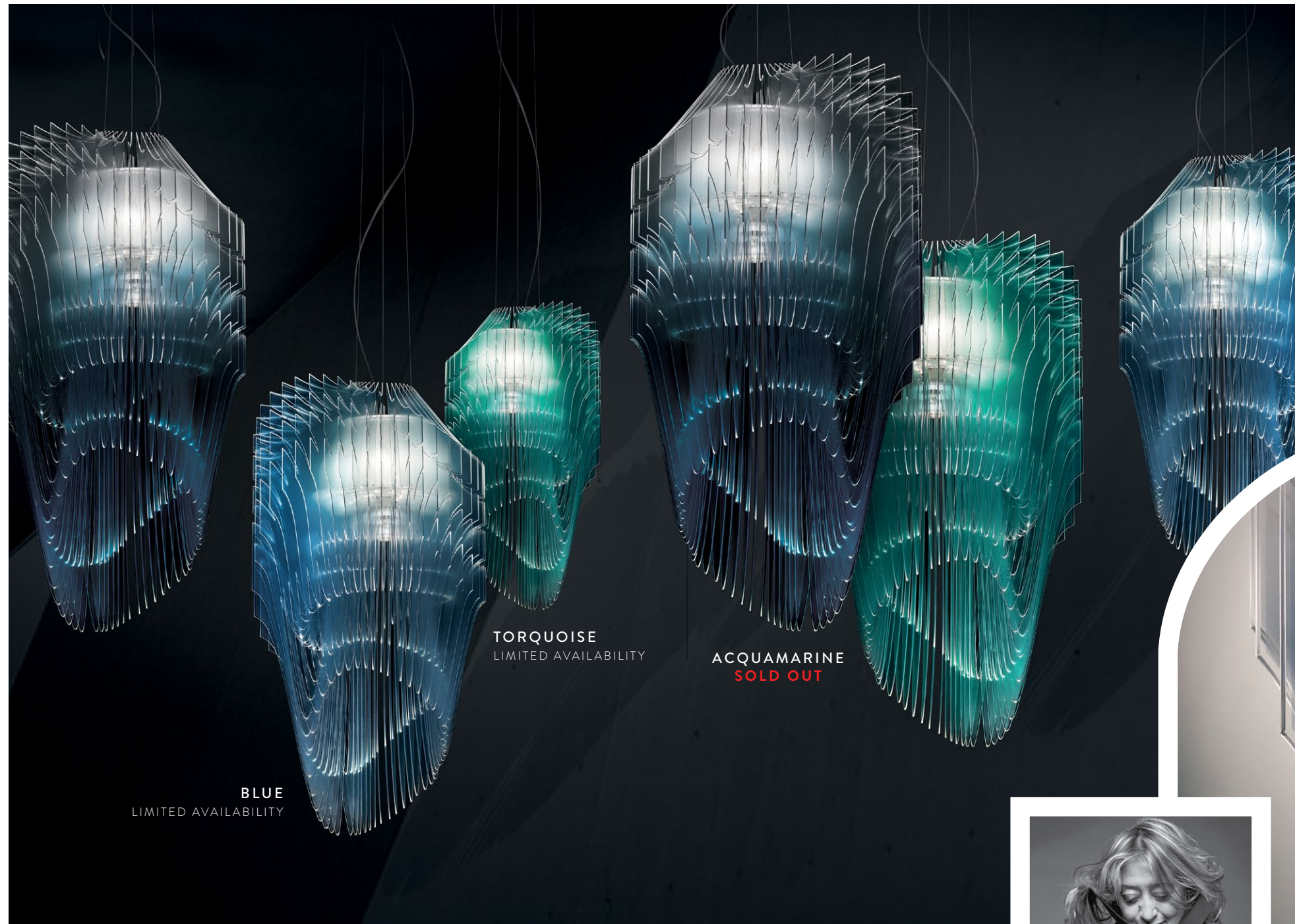

BLUE
LIMITED AVAILABILITY

TORQUOISE
LIMITED AVAILABILITY

ACQUAMARINE
SOLD OUT

A LIMITED SERIES OF 99 PIECES PER COLOUR

Fifty layers of Cristalflex®, each different from the other, create a dynamic yet harmoniously fluid effect. Subtle transparent lines running down the edges of the coloured layers define the lamp's profile, changing from every angle. EVERY PIECE HAS BEEN AUTHENTICATED THROUGH PROGRESSIVE NUMBERING VISIBLE ON THE LAMP ITSELF AND THE MANUFACTURING CERTIFICATION.

50 layers di Cristalflex®, completamente diversi l'uno dall'altro, creano un effetto di fluidità, dinamismo e armonia. La sottile linea trasparente ai bordi dei layer colorati, incontrando la luce, disegna la sagoma della lampada, che modifica la sua prospettiva da ogni punto di vista. L' AUTENTICITÀ DI OGNI SINGOLO PEZZO È GARANTITA DAL NUMERO PROGRESSIVO RIPORTATO SIA SULLA LAMPADA CHE SUL CERTIFICATO DI PRODUZIONE.



ZAHA HADID



SUSPENSION



WALL LAMP



CEILING LAMP



TABLE LAMP



FLOOR LAMP

Avia

THE WHOLE COLLECTION
DESIGN BY ZAHA HADID

technical details p. 449



BLACK FADE

WHITE FADE



TORQUOISE
LIMITED AVAILABILITY

ACQUAMARINE
SOLD OUT

BLUE
LIMITED AVAILABILITY

TRANSFORMING
LIGHT INTO
SCULPTURE

Charlotte

GLOBE
BY DORIANA AND MASSIMILIANO FUKSAS

technical details p. 455



DORIANA AND MASSIMILIANO FUKSAS

SUSPENSION

WALL LAMP
p.332

CEILING LAMP

TABLE LAMP

FLOOR LAMP
p.392

LABOUROUS PATTERNS

Charlotte Globe revisits the archetype of the sphere, visiting the impalpable hexagons of a beehive, only one of Studio Fuksas' architectural preferences.

The external layer of Cristalflex® encloses a luminous internal layer of Lentiflex®, that emits a uniform glow.

Charlotte Globe has four light sources, a magnetic hanging system that makes installation and maintenance simple, and a coaxial wire that gives a touch of charm to the suspension.

Charlotte Globe ricrea – nella forma archetipale della sfera - la trama laboriosa e impalpabile del nido d'ape, segno distintivo degli architetti Fuksas. Realizzata in Cristalflex® – con una struttura interna in Lentiflex® che contribuisce alla diffusione omogenea della luce – Charlotte Globe è dotata di 4 fonti luminose, di attacco magnetico (per una facile installazione e manutenzione) e di un cavo coassiale che accentua il carattere etereo della sospensione.

Size/Dimensioni:

Ø 60 cm x h. 50 cm

Ø 23 1/2" x h. 19"

technical details p. 455





© Fabio Lovino

doriana & massimiliano fuk sas

LIGHT IS THE SOLIDITY OF ARCHITECTURE

Interior design is an act of love destined for our buildings. Our architecture, much like lamps, is magically illuminated at night, and we firmly believe that both natural and artificial light are the solidity of architecture, the only elements that can wholly modify perception. Light is extremely important and precious, like a diamond whose pure facets emanate a spectrum of colours ranging from cool to pink.

Progettare gli interni è un atto di amore verso i nostri edifici. La nostra architettura è molto simile, di notte, a lampade che magicamente si illuminano; crediamo fermamente che luce artificiale e naturale siano una delle certezze dell'architettura, gli unici elementi in grado di modificarne totalmente la percezione. La luce è un elemento estremamente importante e prezioso, come un diamante che con la sua purezza riesce a dare differenti colori alla luce che emana, più o meno freddi, fino al rosa.

Half Charlotte

BY DORIANA AND MASSIMILIANO FUKSAS

technical details p. 455



Size / Dimensioni:

Ø 79 cm x h. 55 cm

Ø 31-1/4" x h. 21-1/2"

Lighting / Illuminazione:

LED 70W - 220V

7.000 Lumen

2700 Kelvin



SUSPENSION



WALL LAMP
p.332



CEILING LAMP



TABLE LAMP



FLOOR LAMP
p.392

Chantal

BY DORIANA AND MASSIMILIANO FUKSAS

technical details p. 454

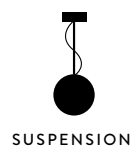
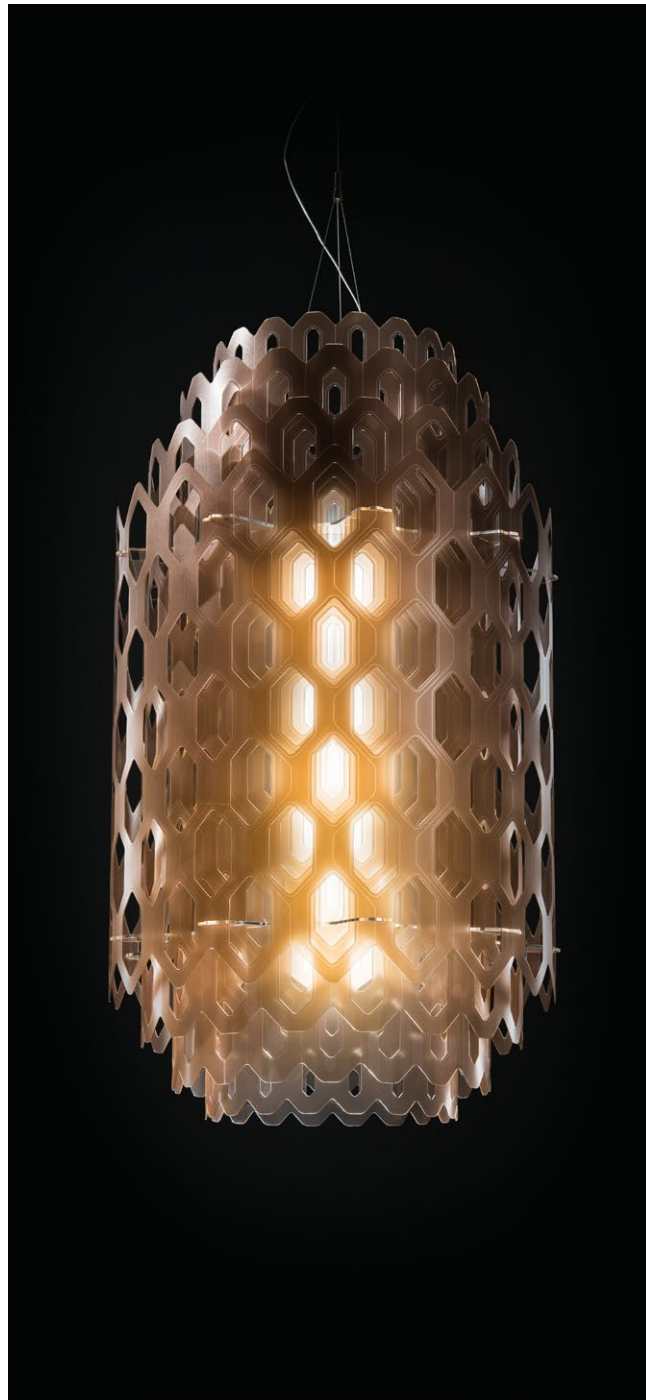

SUSPENSION



WALL LAMP



CEILING LAMP

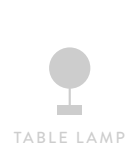

TABLE LAMP



FLOOR LAMP



GERMAN
DESIGN
AWARD
SPECIAL
2016

Chantal's sculptural shape seems to be molded from a singular, industrious frame, much like honeycomb.

La forma scultorea di Chantal sembra modellarsi da un unico volume, con una trama laboriosa a tratti impalpabile, come quella del nido d'ape.

Clizia

MAMA NON MAMA
DESIGN BY ADRIANO RACHELE

technical details p. 456

SUSPENSION

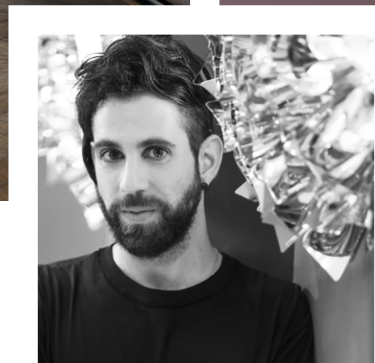

ADRIANO RACHELE

Clizia Large:
Ø 78 cm x h. 28 cm
Ø 30-3/4" x h. 11"



SUSPENSION



WALL LAMP
p.346



CEILING LAMP
p.218



TABLE LAMP
p.272



FLOOR LAMP



Clizia Large:
 Ø 78 cm x h. 28 cm
 Ø 30-3/4" x h. 11"

LOVES ME, LOVES ME NOT?

Clizia Mama Non Mama is an ode to joy, femininity, primordial love, and pure emotion, handcrafted from interlocking Cristalflex® petals. This bouquet's light, delicate petals bring a soft breeze of balanced allure into any interior.

Realizzata a mano tramite un sistema di incastrati di Cristalflex® è un inno alla gioia, alla femminilità, all'amore primordiale, alla purezza dei sentimenti. I petali leggeri e delicati di questo bouquet luminoso portano negli interni una ventata di aria fresca e un allure equilibrato.

Clizia Medium:
 Ø 53 cm x h. 25 cm
 Ø 20-3/4" x h. 9-3/4"

Clizia PXEL

DESIGN BY ADRIANO RACHELE

technical details p. 456

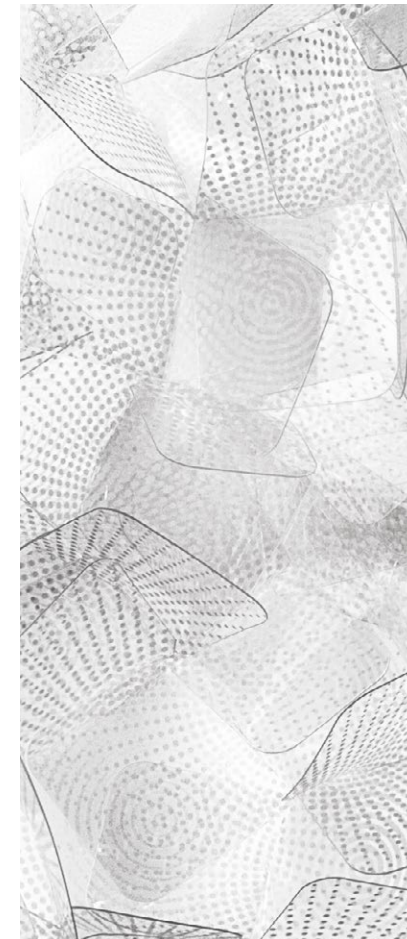

A GREEK NYMPH TRANSPORTED TO THE DIGITAL AGE

Clizia is covered in pixels; a high-tech pattern meets soft tones that enhance the suspensions' lush volume. The red hanging wire gives a creative touch, but for those looking for something minimal, a transparent one is available. A subtle dusting of white helps to evenly diffuse light without any glare.

Clizia si tinge di Pixel: una decorazione high-tech in tonalità tenui che si dipana sul volume rigoglioso della lampada a sospensione. Il cavo rosso, che aggiunge al prodotto un guizzo creativo, può essere richiesto anche trasparente. La spolverata di bianco all'interno del decoro contribuisce a diffondere uniformemente la luce e evitare l'abbagliamento.



SUSPENSION



WALL LAMP
p.348



CEILING LAMP
p.220



TABLE LAMP



FLOOR LAMP

Clizia FUMÉ

DESIGN BY ADRIANO RACHELE

technical details p. 456



PERFECT BALANCE
OF REFLECTIONS AND
TRANSPARENCIES

Large: Ø78 cm x h. 28 cm
 Ø30-3/4" x h. 11"
 Small: Ø53 cm x h. 25 cm
 Ø20-3/4" x h. 9-3/4"
 Fully crafted by hand.
 Integrated magnetic system.
 Allestita completamente a
 mano. Dotata di attacco
 magnetico.

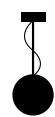

SUSPENSION



WALL LAMP
p.351



CEILING LAMP
p.222



TABLE LAMP
p.274



FLOOR LAMP
p.416

Clizia

DESIGN BY ADRIANO RACHELE

technical details p. 456

SUSPENSION



Clizia Medium Blue



Clizia Purple



Clizia Large Orange

A CLOUD THAT CAPTURES THE FIRST CHANGING RAYS OF MORNING SUN

Clizia is one of Slamp's iconic collections, taking its name from an elegant and graceful nymph immersed in nature. Every version is handcrafted by Slamp's selected artisans, and every petal is hand placed into a lush bouquet. The magnetic hanging system allows the decorative shade to be removed and replaced with a simple click, facilitating installation and maintenance.

Clizia - collezione iconica di Slamp - prende il nome dalla ninfa mitologica da cui eredita grazia, eleganza e naturalezza. Tutte le versioni di Clizia sono allestite a mano dalle Sarte della Luce di Slamp incastrando i vari petali fino a creare un volume rigoglioso. Grazie all'attacco magnetico, il decoro si stacca dalla fonte luminosa con un semplice click per facilitare l'installazione e la pulizia del diffusore.



SUSPENSION



WALL LAMP
p.350



CEILING LAMP
p.224



TABLE LAMP
p.278



FLOOR LAMP
p.416



Clizia Large Black



Clizia Large White

Large: Ø78 cm x h. 28 cm
 Ø30-3/4" x h. 11"
 Small: Ø53 cm x h.25 cm
 Ø20-3/4" x h. 9-3/4"
 Fully crafted by hand.
 Integrated magnetic system.
 Allestita
 completamente a mano.
 Dotata di attacco magnetico .



lorenza — bozzoli

LIGHT MAKES A COLOURFUL WORLD

When I was a little girl, I loved to explore my grandmother's trunks; she was an opera singer. From there, with my bubble skirt and 50's shoes, I would hop on my Ciao motorbike and make my way to high school. While outside, student protests were taking place, I was thrilled by the feminine positivity that filled my heart at the time, and it was a heart that inspired my first design for an exhibition in the Triennale in the 90's. My world is multicoloured, and light is the vessel that transmits the infinite shades it possesses. I design my lamps to adorn a space with the same beauty that jewelry brings to a woman's body.

Quando ero bambina amavo curiosare tra i bauli della nonna, che era una cantante lirica. Da lì tiravo fuori le gonne a palloncino e le scarpe dal sapore anni 50 che, in sella al mio Ciao, indossavo per andare al liceo artistico. Mentre fuori imperversava la lotta studentesca, io mi inebriavo della positività e della femminilità che quegli anni avevano lasciato nel mio cuore. È stato proprio un cuore il mio primo oggetto di design, per una mostra in Triennale negli anni 90. Il mio è un mondo a colori, in cui la luce è l'elemento che permette di vedere le mille sfumature che lo compongono. Con le mie lampade cerco di portare nelle case la stessa bellezza di un gioiello sul corpo di una donna.

La Lollona

DESIGN BY LORENZA BOZZOLI

technical details p. 470

SUSPENSION



LORENZA BOZZOLI

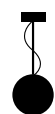

SUSPENSION



WALL LAMP
p.334



CEILING LAMP



TABLE LAMP



FLOOR LAMP
p.402



La Lollona White

THE GLAMOUR
AND OPULENCE
OF EXTRA-
LARGE
ILLUMINATED
DESIGN



La Lollona Gradient

SHIPPED SUPERFLAT, MAX. WEIGHT 30 KG, AND CAN BE CUSTOMISED UPON REQUEST

Extraordinary view, easy to install: La Lollona is shipped assembled. All there is left to do is to connect and hang it, basking in its glow. The five tier version reaches 130 cm, with 132 cylinders available in a selection of colours and finishes. The suspension's colours and size can be customised upon request, fitting for large scale installations.

Facile da installare e straordinaria da ammirare: La Lollona viene spedita completamente pre-assemblata lasciando al cliente il solo compito di sospenderla, fare i collegamenti elettrici e godere della sua spettacolarità. Nella versione a 5 livelli, si raggiunge il diametro di 130 cm con 132 cilindri disponibili in varie colorazioni e finiture. Customizzabile su richiesta - sia nei colori che nelle taglie - per progetti di larga scala.

La Lollo XL

DESIGN BY LORENZA BOZZOLI

technical details p. 469



La Lollo XL Gradient

- 
SUSPENSION
- 
WALL LAMP
 p.334
- 
CEILING LAMP
- 
TABLE LAMP
- 
FLOOR LAMP
 p.402

A SOPHISTICATED LOOK FOR EVERY OCCASION

Stamp's unique, flexible technopolymers radiate around a central LED source in varying colours and finishes, creating a charming, solid lamp inspired by the roaring 50's. Available in four colour schemes and three sizes.

Cilindri di varie finiture e colori - realizzati con i tecnopolimeri flessibili e unici di Stamp - si dispongono intorno a un anello centrale a LED integrando definendo una lampada solida e appariscente ispirata ai meravigliosi anni '50. Disponibile in 4 colori e in 3 diverse taglie.

Size / Dimensioni:
 Ø 79 cm x h. 55 cm
 Ø 31-1/4" x h. 21-1/2"

Lighting / Illuminazione:
 LED 70W - 220V
 7.000 Lumen
 2700 Kelvin



La Lollo XL White

SUSPENSION

La Lollo LARGE

DESIGN BY LORENZA BOZZOLI

technical details p. 469

SUSPENSION



La Lollo Large Gold



La Lollo Large White

A TRIBUTE
TO THE
ROARING
50'S



SUSPENSION



WALL LAMP
p.334



CEILING LAMP



TABLE LAMP



FLOOR LAMP
p.402

La Lollo MEDIUM

DESIGN BY LORENZA BOZZOLI

technical details p. 469

SUSPENSION



La Lollo Medium Pewter/White



La Lollo Medium Gold

The techno-polymer cylinders, alternate around a central, LED illuminated ring.

Una serie di cilindri di tecnopolimeri, infrangibili e leggeri sono disposti intorno ad un anello di luce a LED

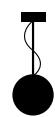

SUSPENSION



WALL LAMP
p.334



CEILING LAMP



TABLE LAMP



FLOOR LAMP
p.402

La Belle Étoile

DESIGN BY ADRIANO RACHELE

technical details p. 469

SUSPENSION

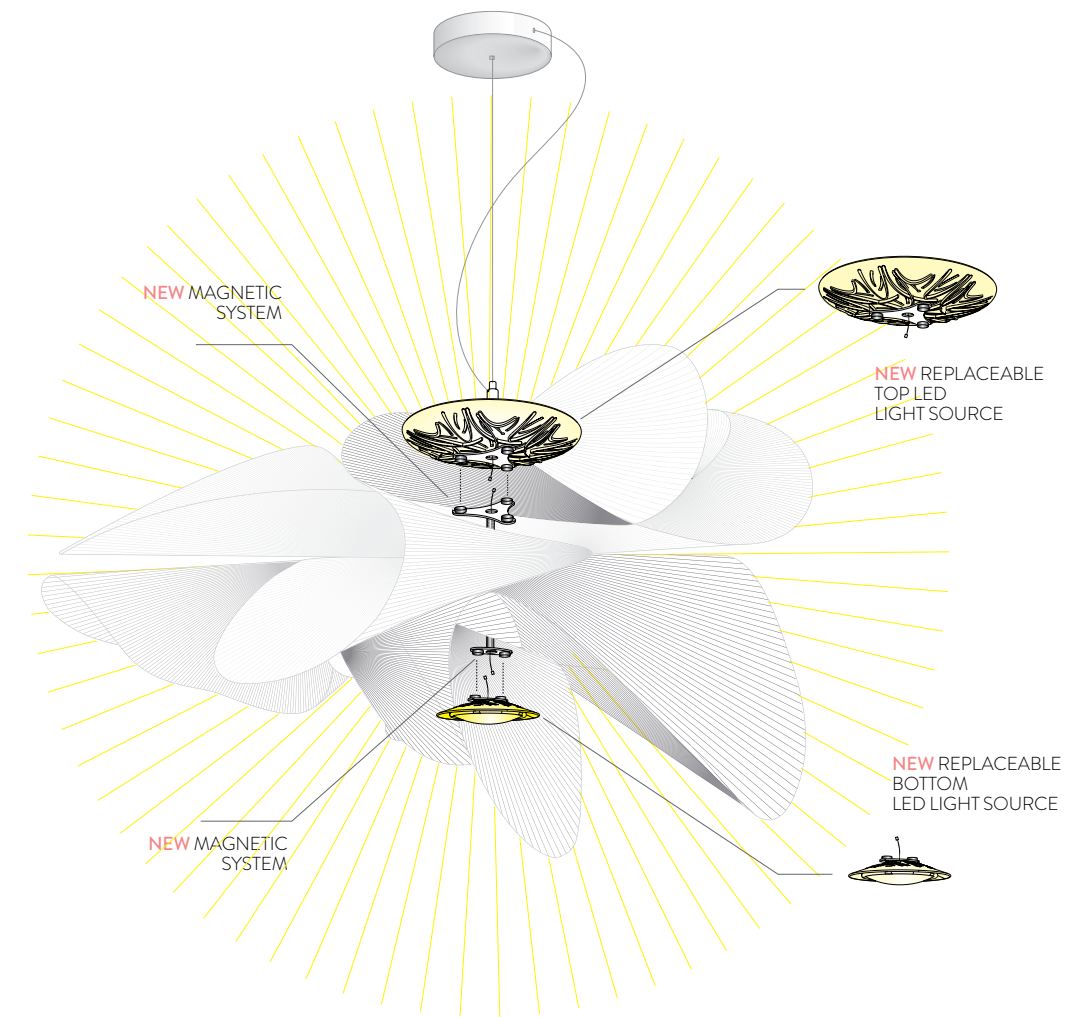

THE LED SOURCE CAN BE EASILY AND QUICKLY CHANGED

Light, dynamic, and as elegant as a twirling ballerina. La Belle Étoile is handmade by Slamp's artisans, experts in both manual art and technology. The ad hoc LED source can be easily changed thanks to Slamp's patented magnetic system.

Dinamica, leggera ed elegante come una ballerina dai volteggi aggraziati. La Belle Étoile è realizzata a mano dalle Sarte della Luce di Slamp, unendo artigianalità e tecnologia: il circuito a LED realizzato ad hoc è sostituibile tramite il sistema magnetico brevettato da Slamp.



ADRIANO RACHELE

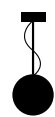

SUSPENSION



WALL LAMP
p.362



CEILING LAMP
p.228



TABLE LAMP



FLOOR LAMP



PLAY VIDEO



La Belle Étoile Large



La Belle Étoile Medium

Changeable LED source through the patented magnetic system. Crystal counter-balance "drop" included.

Sorgente LED sostituibile tramite attacco magnetico brevettato. Contrappeso in cristallo incluso.

Étoile

DESIGN BY ADRIANO RACHELE

technical details p. 461

SUSPENSION

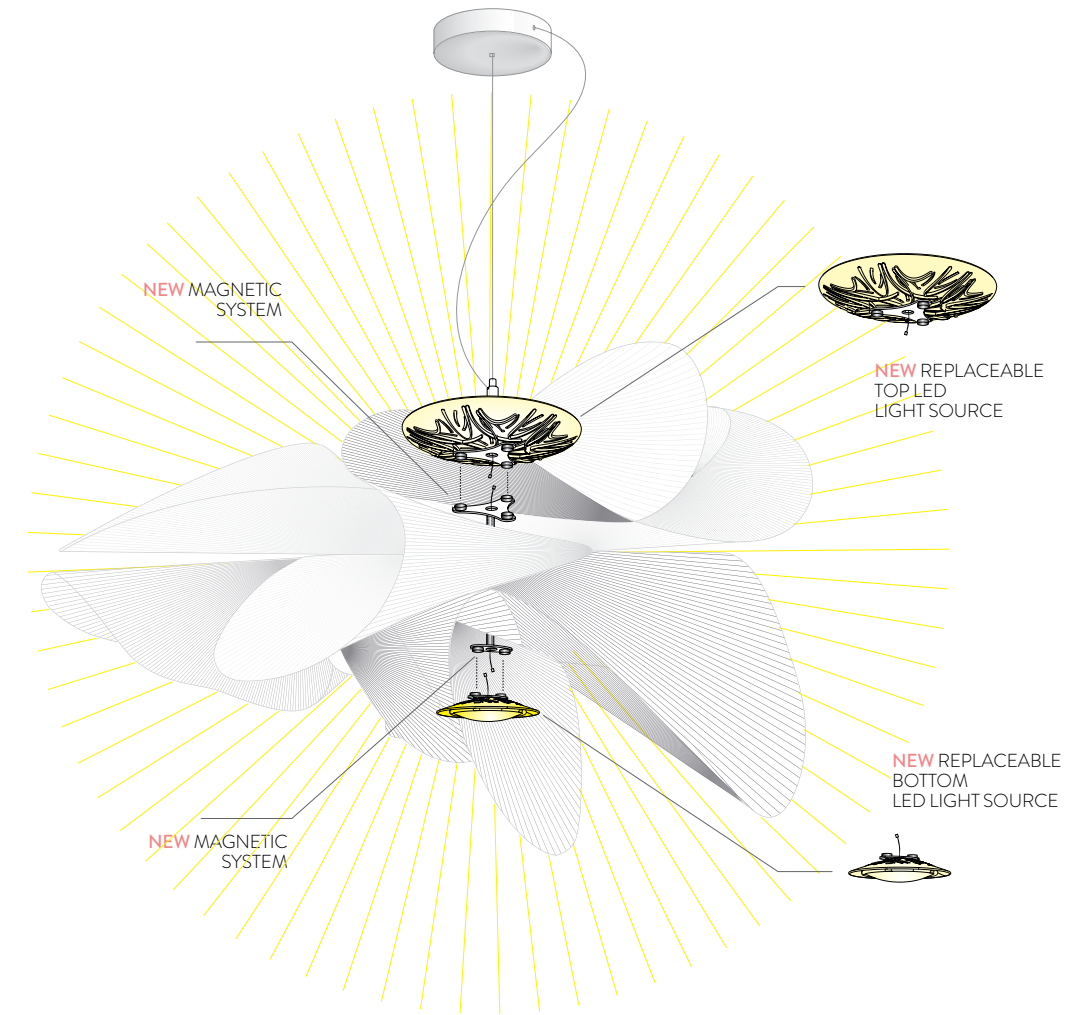

LIGHTWEIGHT AND UNBREAKABLE, HANDCRAFTED IN SLAMP'S ATELIER

Stunning, unbreakable: Étoile is a suspension inspired by the delicate beauty of a ballerina's tutù, an original touch for any minimal space. A unique, luminous sculpture that spans and dims from 0 to 100, fulfilling every lighting desire.

Infrangibile e brillante, Étoile è la sospensione ispirata al tutù di una ballerina che apporta bellezza e originalità anche alle mise en place più minimaliste. Protagonista indiscussa della scultura luminosa è la luce, la cui intensità può variare da 0 a 100 per assecondare completamente i desideri delle persone che la circondano.



SUSPENSION



WALL LAMP
p.364



CEILING LAMP
p.230



TABLE LAMP



FLOOR LAMP

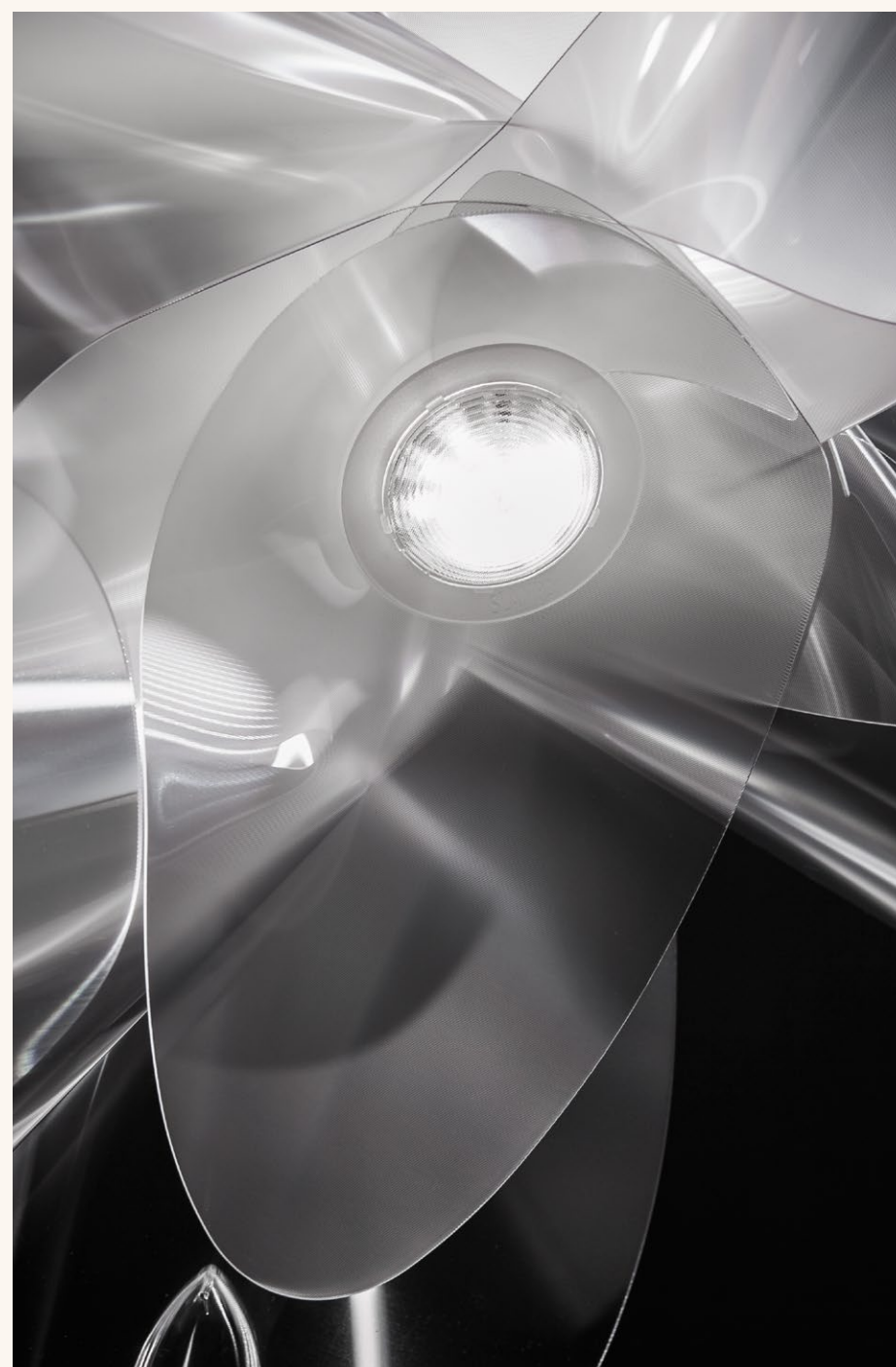

Changeable LED source through the patented magnetic system. Crystal counter-balance "drop" included.

Sorgente LED sostituibile tramite attacco magnetico brevettato. Contrappeso in cristallo incluso.

Veli

FOLIAGE
DESIGN BY ADRIANO RACHELE

technical details p. 479

SUSPENSION



Size / Dimensioni:
 L: Ø 55 cm x h. 45 cm
 Ø 21-1/2" x h. 17 1/2"
 M: Ø 45 cm x h. 35 cm
 Ø 17-1/2" x h. 13-3/4"

Lighting / Illuminazione:
 L: 4x12W LED Filament Bulb E27/E26
 M: 2x12W LED Filament Bulb E27/E26

- 
 SUSPENSION
- 
 WALL LAMP
 p.352
- 
 CEILING LAMP
 p.206
- 
 TABLE LAMP
 p.290
- 
 FLOOR LAMP



VELI FOLIAGE IS AN ODE TO OUR PLANET

In this frenetic life, getting in touch with nature is a luxury. Veli Foliage brings a lush touch to residential spaces. The handcrafted collection is a union of Veli's soft sartorial features and nature's perfection.

In un'epoca in cui il contatto con la natura diviene lusso della vita frenetica, la Veli Foliage ne porta la freschezza all'interno dell'ambiente domestico. Realizzata completamente a mano, la collezione è un connubio tra la morbidezza del mondo sartoriale di Veli e la perfezione del mondo naturale.



Available with red wrapped wire or transparent wire.

Disponibile sia con cavo di tessuto rosso calzato che trasparente.



Veli Couture with red wrapped wire

INSPIRED BY THE TEXTURE OF MODERN TEXTILES

A soft finish that was inspired by modern fabric textures. Veli Couture fills and envelops any space, setting it apart with its aesthetics and lush decorative characteristics.

Con una inedita finitura ispirata alle texture tessili contemporanee, Veli Couture è perfetta per assicurare agli ambienti una luce calda unitamente all'estetica e al decoro rigoglioso che la contraddistinguono.



Veli Couture with transparent wire

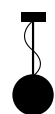

SUSPENSION



WALL LAMP
p.354



CEILING LAMP
p.208



TABLE LAMP
p.292



FLOOR LAMP

Veli

MINI COUTURE
DESIGN BY ADRIANO RACHELE

technical details p. 477

SUSPENSION



Veli Mini Quartet Couture



Veli Mini Single Couture



Veli Mini Trio Couture

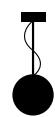

SUSPENSION



WALL LAMP
p.354



CEILING LAMP
p.208



TABLE LAMP
p.292



FLOOR LAMP



PLAY VIDEO

Veli

GOLD/SILVER/COPPER
DESIGN BY ADRIANO RACHELE

technical details p. 477



Veli Copper Collection at Erwin Restaurant, Moscow.

ENHANCE YOUR SPACE WITH A TOUCH OF GLAM

Absolute prestige and versatility for both domestic and contract design. Handcrafted of noble, luxurious technopolymers.

Un must-have per conferire ad ambienti domestici e contract una sensazione di prestigio assoluto, lusso e versatilità. Realizzate a mano con tecnopolimeri nobili, lucenti e preziosi.



Veli Silver



Veli Gold



SUSPENSION



WALL LAMP
p.360



CEILING LAMP
p.212



TABLE LAMP



FLOOR LAMP

Veli PRISMA

DESIGN BY ADRIANO RACHELE

technical details p. 477

SUSPENSION



Lighting /Illuminazione:
 M: 2 x 12W LED Filament Bulb
 E27/E26;
 L: 4 x 12W LED Filament Bulb
 E27/E26.
 Integrated magnetic system.
 Dotata di attacco magnetico.

- 
 SUSPENSION
- 
 WALL LAMP
 p.358
- 
 CEILING LAMP
 p.210
- 
 TABLE LAMP
- 
 FLOOR LAMP



THE MAGNETIC HANGING DEVICE SIMPLIFIES EVERYTHING

Inspired by the high fashion world, where folds, pleats and soft structural shapes reign, Veli is a sophisticated, glamorous collection featuring a series of handcrafted elements carefully connected in a sinuous, elegant design.

Ispirata al variegato mondo dell'haute couture dove con pieghe, panneggi e intagli si dà forma a morbidi volumi tridimensionali, Veli è una collezione di lampade glamour e sofisticate realizzate tramite un sistema di incastri eseguiti a mano.



Veli Suspension Large Opal



SUSPENSION



WALL LAMP
p.356



CEILING LAMP
p.214



TABLE LAMP
p.292



FLOOR LAMP

Veli⁷

DESIGN BY ADRIANO RACHELE

technical details p. 478



Lighting / Illuminazione:
 9 x 12W LED Filament Bulb
 E27/E26;

Integrated magnetic system.
 Dotata di attacco magnetico.

Electric wire 400 cm
 Cavo elettrico di 400 cm.

SUSPENSION

- 
 SUSPENSION
- 
 WALL LAMP
 p.356
- 
 CEILING LAMP
 p.214
- 
 TABLE LAMP
 p.292
- 
 FLOOR LAMP



© Stefan Ruiz

daniel — libeskind

LIGHT IS PURE LOVE

You have to get inspiration from life, and working with light is no exception. When we inherit a space, albeit large or quite small, we can transform it, which in turn completely transforms our feelings, emotions, and sense of the world. The beauty of design is that it is always rewarding, especially when it is aesthetic and exhibits social ideas. Good design has to use efficient and sustainable materials to endure and create a heritage, and above all, it must have something specifically strange about it. Light is probably the most mysterious dimension of reality, and working with it is fascinating, complex and dynamic. Designing illumination is, well, a great joy, and I can say, I have been very lucky.

L'ispirazione si trova nella vita di tutti i giorni, anche quando si ha a che fare con la luce, che è probabilmente uno degli elementi più misteriosi della realtà, affascinante, complesso e totalmente dinamico; progettare con la luce è una grande gioia e, per me, una grande fortuna. Quando ci appropriamo di uno spazio, grande o piccolo che sia, abbiamo il potere di modificarlo con la luce ed esso, a sua volta, di modificare i nostri sentimenti, le emozioni e il senso della vita. Il design per me è assolutamente appagante, specie se bello e socialmente utile. In generale un buon prodotto, per entrare nella storia, deve fare uso di materiali efficienti e sostenibili, ma soprattutto avere qualcosa di inusuale, di strano...

Cordoba

DESIGN BY DANIEL LIBESKIND

technical details p. 458

SUSPENSION



A DECONSTRUCTIVIST LAMP WITH A CULTURAL TWIST

Elements of Deconstructivist architecture, distilled in an original, sustainable, and luminous sculpture. Asymmetrical fragments, seemingly unconnected, combine in a lamp that is far from conventional design, inspired by the mysticism that dominates the Spanish city of the same name.

I segni del decostruttivismo architettonico si delineano in una scultura luminosa contemporanea, originale e sostenibile. Asimmetrie e frammenti apparentemente disarticolati si sintetizzano in una lampada lontana dai canoni estetici tradizionali, ispirata alla città spagnola, dove architetture e luci dipingono un'atmosfera mistica.



Lighting /Illuminazione:
130W 110 - 240 Vac/24 Vdc
15.000 Lumen - 2900 Kelvin

Size/Dimensione:
76 x 104 x h. 55 cm
30" x 41" x h. 21"



SUSPENSION



WALL LAMP



CEILING LAMP



TABLE LAMP



FLOOR LAMP



DARING ARTISTRY AND LIGHTING COMFORT

A mathematical algorithm combines two dimensional technopolymer sheets into a suspension that harmoniously glows. Cordoba is handcrafted, offering endless angles from every viewpoint.

Lastre bidimensionali di tecnopolimeri prendono vita da un algoritmo matematico e diffondono la luce in maniera armonica. Cordoba è allestita completamente a mano, offrendo diversi punti di vista a chi la osserva nella sua interezza.



OUR
UNIQUE
TECHNO-
POLYMERS
TRANSFORM
THROUGH AN
ALGORITHM

Hanami

DESIGN BY ADRIANO RACHELE

technical details p. 465

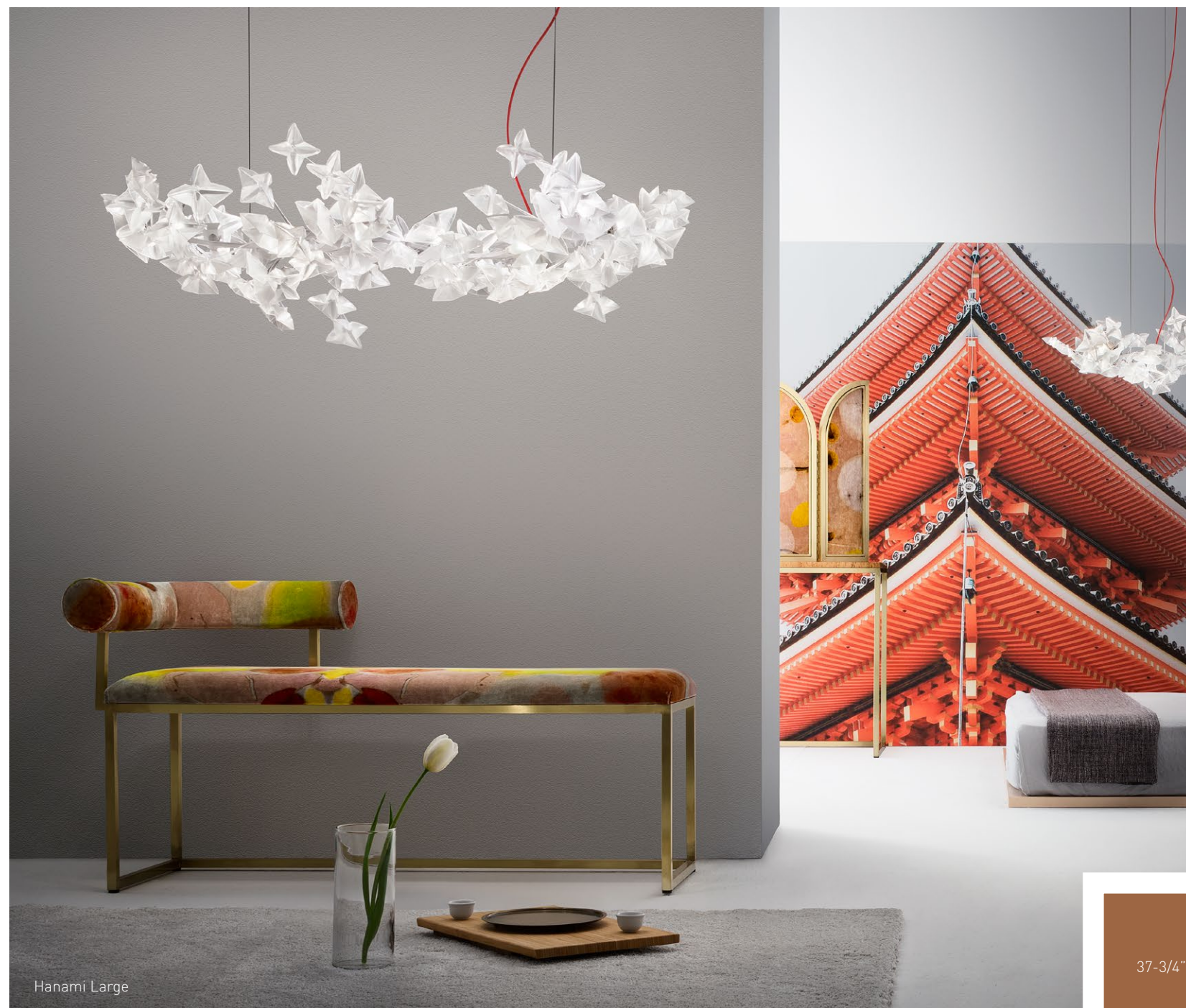

Hanami Large



Hanami Large

Size / Dimensioni:
L: 96 x 60 x h.26 cm
37-3/4" x 23-1/2" x h.10-1/4"
M: 53 x 35 x h.25 cm
20-3/4" x 13-3/4" x h.9-3/4"
Lighting / Illuminazione:
L: 10 X 5W G9 LED Bulb
M: 5 X 5W G9 LED Bulb

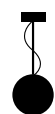

SUSPENSION



WALL LAMP
p.344



CEILING LAMP
p.226



TABLE LAMP



FLOOR LAMP



Hanami Small

JAPANESE
CHERRY
BLOSSOMS,
YOUR
OWN
INTIMATE
RITUAL

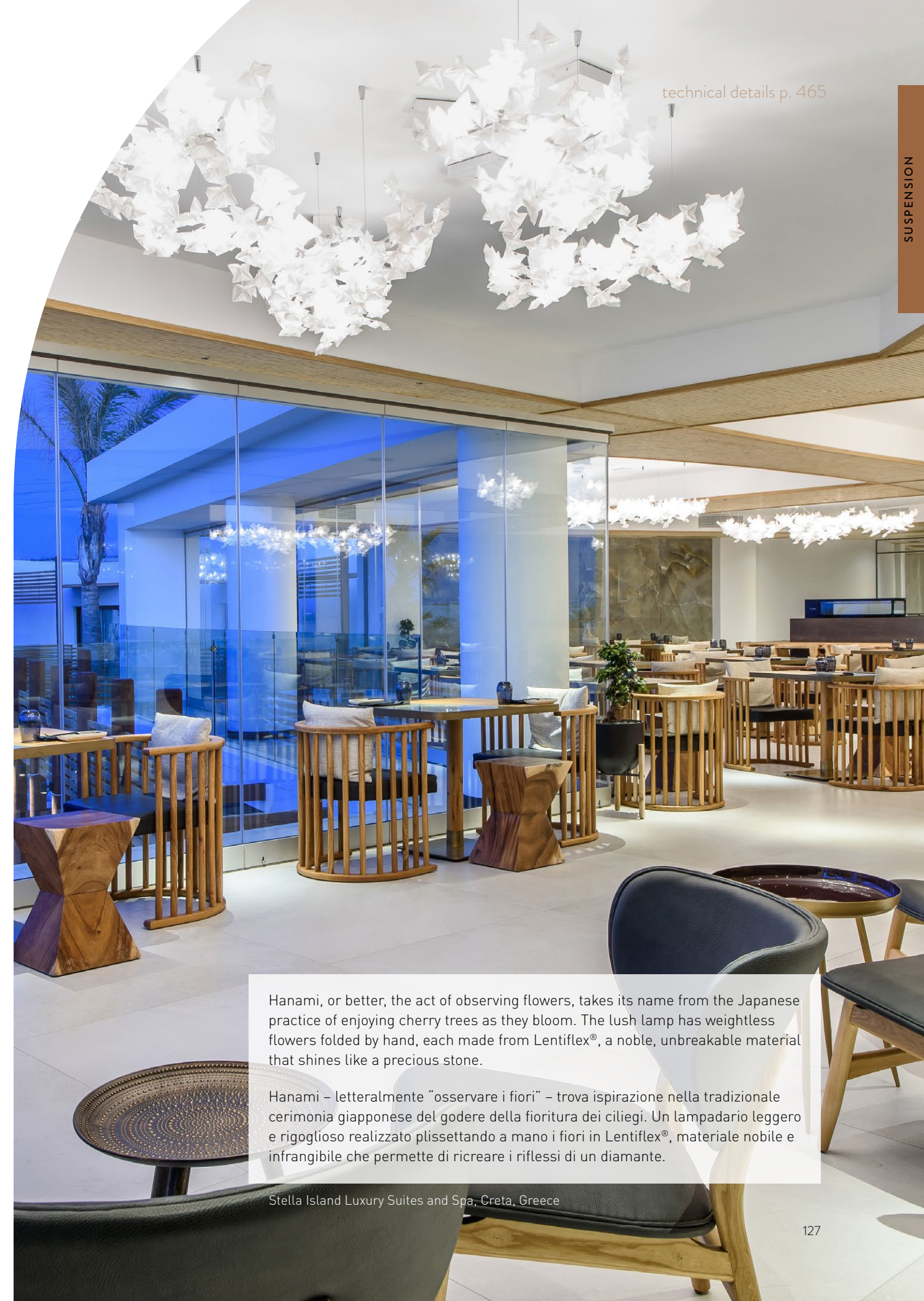

Hanami, or better, the act of observing flowers, takes its name from the Japanese practice of enjoying cherry trees as they bloom. The lush lamp has weightless flowers folded by hand, each made from Lentiflex®, a noble, unbreakable material that shines like a precious stone.

Hanami – letteralmente “osservare i fiori” – trova ispirazione nella tradizionale cerimonia giapponese del godere della fioritura dei ciliegi. Un lampadario leggero e rigoglioso realizzato plissettando a mano i fiori in Lentiflex®, materiale nobile e infrangibile che permette di ricreare i riflessi di un diamante.

Stella Island Luxury Suites and Spa, Creta, Greece



© Yorgos Kaplanidis

robert— wilson

WITHOUT LIGHT THERE IS NO SPACE

"Light is the most important element in creating space. It should always be the starting point and the finality of architecture, whether exterior or interior. Light is what creates the worlds we live in, whether on the street, in the theater, in a restaurant, or in your dining room. It is what gives our environment special character. Paris is a beautiful city because of light. Roman light is unique, as is that of Greece, San Francisco, and Texas. And SLAMP lamps are unique in this way."

La luce è elemento determinante nel processo di creazione dello spazio, punto di inizio e fine di ogni architettura, tanto di un interno quanto di un esterno. Per la strada, in un teatro, in un ristorante e in un ambiente domestico è la luce a definire i confini del mondo in cui viviamo, a dare a ciò che ci avvolge un carattere unico. Parigi sarebbe la stessa senza le sue luci? E cosa sarebbe Roma senza l'incrocio del sole sulle sue architetture? E la Grecia, San Francisco, il Texas? Ci sono luoghi del mondo che varrebbe la pena ricordare senza luce? È in questa abilità nel creare atmosfere memorabili che Slamp trova la sua unicità".

La Traviata

LIGHT SCULPTURE
DESIGN BY ROBERT WILSON

technical details p. 470

SUSPENSION

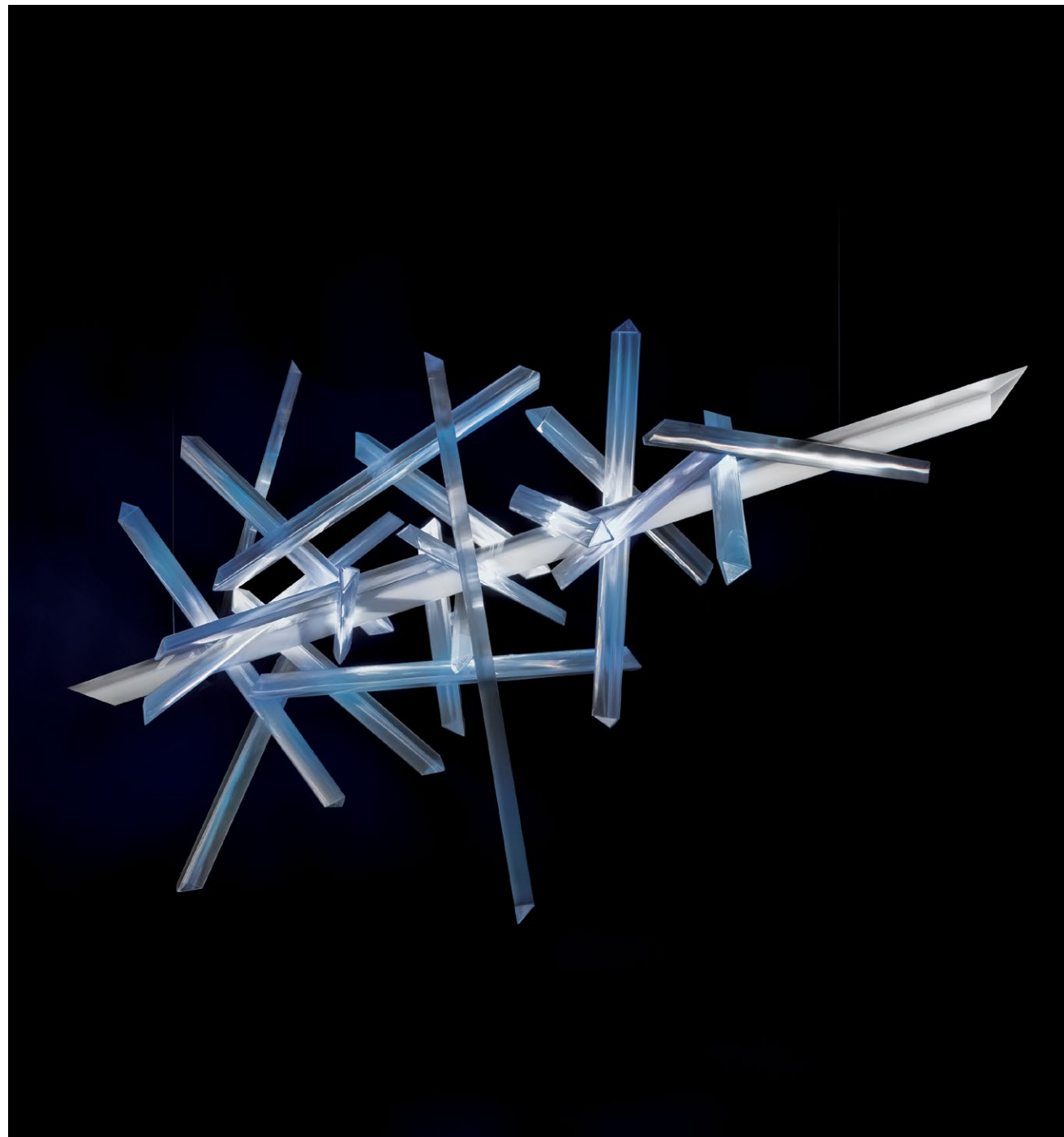

A luminous sculpture: the methacrylate core is either 180 or 220 cm. long, illuminated evenly from end to end.

Scultura luminosa composta da un elemento centrale in metacrilato di 180 o 220 cm, illuminato in modo uniforme.

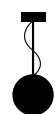

SUSPENSION



WALL LAMP



CEILING LAMP



TABLE LAMP



FLOOR LAMP



La Traviata Light Sculpture Installation in the Acropolis Museum, Athens, Parthenon Gallery.
 Installazione della scultura Luminosa La Traviata nell' Acropolis Museum ad Athene, Parthenon Gallery.

A LUMINOUS SCULPTURE TAKEN FROM VERDI

La Traviata is a complete work of art, blending architecture, light, poetry, dance, and movement. Producer Robert Wilson transferred his own dialogue between theatre and design to a luminous sculpture; the colours and intensity can be changed with the included remote control.

La Traviata è un'opera d'arte totale: è architettura, è luce, è poesia, è danza, è movimento. Con un dialogo tra design e teatro, il drammaturgo Robert Wilson ha trasferito il suo linguaggio in una scultura luminosa dotata di un sistema di comando a distanza per gestire colori e intensità luminosa.



PLAY VIDEO



Installation in the Cantina Felsina, Tuscany.
 Installazione presso la Cantina Felsina (Toscana).

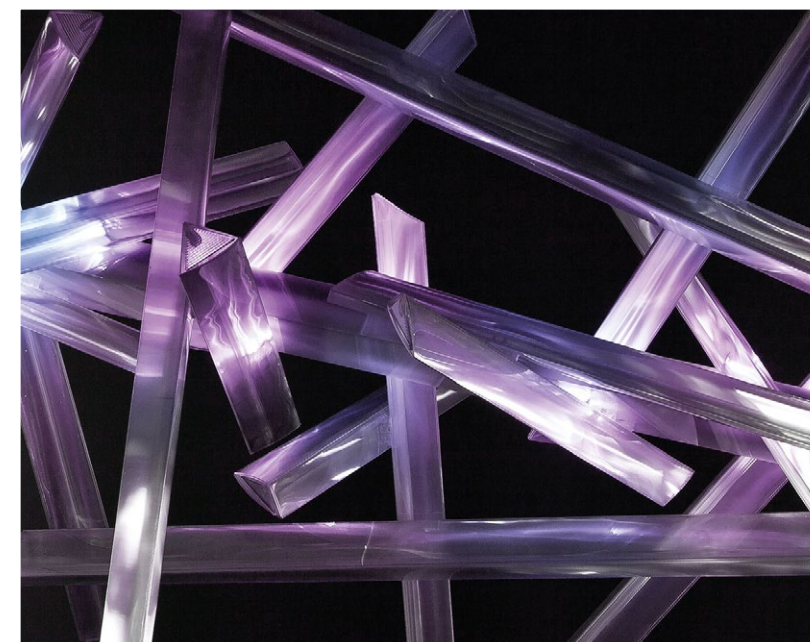



This page: installation at McKim Medal Gala in the American Academy in Rome. The next page: the exclusive mise-en-place in Milan's Teatro di Triennale.

In questa pagina: installazione presso l' American Academy di Roma per l'evento McKim Medal Gala. Nella successiva, esclusiva mise-en-place presso il teatro della Triennale di Milano.

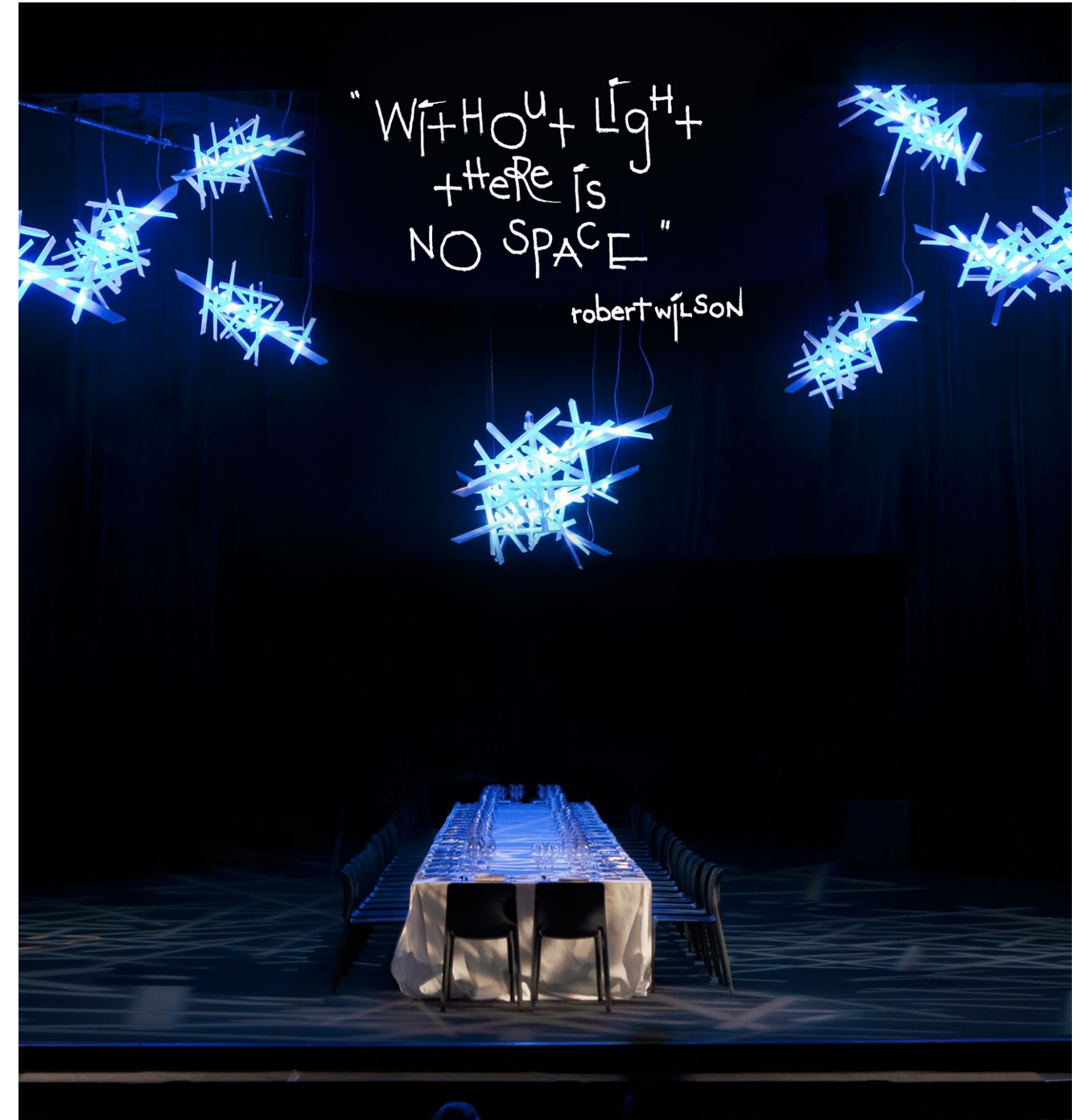

A remote controls the colours and intensity of each LED RGB in the individual lances with either the artist's pre-set chromatics, or at the user's discretion.

Dotata di un telecomando di gestione colori e intensità luminosa. LED RGB all'interno delle singole "lance" con pre-set cromatici dell'artista o a discrezione dell'utente.



Flora

DESIGN BY ZANINI DE ZANINE

technical details p. 464

idea^{idSA}
BRASIL '14
AWARD



Flora Gold



Flora Silver



SUSPENSION



WALL LAMP



CEILING LAMP



TABLE LAMP



FLOOR LAMP
p.398



ZANINI DE ZANINE



60 PETALS
SURROUND
A SATIN
SPHERE
ILLUMINATED
FROM ITS CORE

Flora Pewter



Flora White

In a land kissed by the sun, and a natural world filled with colour, artisan expertise brings life to highly expressive pieces dense with archetypes, like Flora, the collection inspired by the Monstera Deliciosa plant. Available in 2 dimensions and 5 colours.

In una terra baciata dal sole, dove natura, maestria artigiana e colori danno vita a segni altamente espressivi e densi di archetipi, nasce Flora, collezione ispirata alla pianta Monstera Deliciosa. Disponibile in 2 dimensioni e 5 finiture.

Hugo

ARCHITECTURAL SYSTEM
DESIGN BY SLAMP CREATIVE DEPARTMENT

technical details p. 466

SUSPENSION



The Hugo Architectural System supports up to 7, one meter modules on a single electric input.
Il sistema Hugo Architectural permette di connettere fino a 7 lampade da 1 metro con un solo attacco elettrico.



- 
 SUSPENSION
- 
 WALL LAMP
- 
 CEILING LAMP
- 
 TABLE LAMP
- 
 FLOOR LAMP
 p.386

ALIGNMENT ROD UPON REQUEST

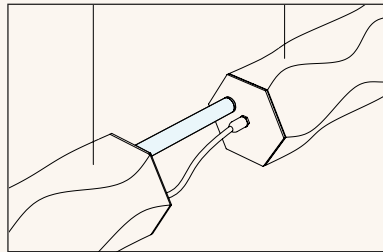

Plexiglass magnetic alignment rod to perfectly align modules are available upon request

Disponibile su richiesta una barretta di plexiglas trasparente con estremità magnetiche per tenere i moduli perfettamente allineati.

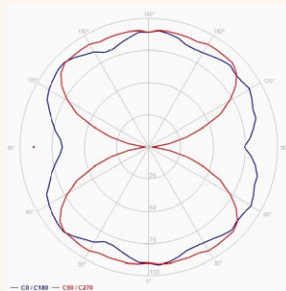

PHOTOMETRIC DIAGRAM, HUGO.
DIAGRAMMA FOTOMETRICO DELLA HUGO.

COMPLIANT WITH THE
UNI EN 12464-1:2011 STANDARD

Hugo offers the same qualities of traditional technical lighting without losing Slamp's iconic aesthetic value. The main office requirements established in the UNI EN 12464-1:2011 require an average illumination of 500 lx on work surfaces, a uniformity coefficient U0 greater than 0.6, and a glare value (UGR) of less than 19. Both the Prisma and White versions conform to these requirements, including a CRI (colour rendering index) greater than 90.

Hugo offre una qualità di luce paritetica a quella degli apparecchi per illuminazione tecnica, in aggiunta al valore estetico tipico dei prodotti Slamp. I principali requisiti illuminotecnici per gli uffici, così come stabiliti all'interno della norma UNI EN 12464-1:2011 prevedono un livello di illuminamento medio sul piano di lavoro pari a 500 lx, un coefficiente di uniformità U0 maggiore di 0,6 e un valore di abbagliamento (UGR) minore di 19. I calcoli illuminotecnici eseguiti sia con la fotometria della versione Prisma che della White dimostrano la completa rispondenza dei progetti ai parametri richiesti, incluso l'indice di Resa Cromatica (CRI) > 90.



HUGO:
Ideal for office illumination in accordance with **UNI EN 12464-1:2011**
Perfetta per l'illuminazione degli uffici in base alla normativa **UNI EN 12464-1:2011**

Hugo

DESIGN BY SLAMP CREATIVE DEPARTMENT

technical details p. 467



Objects illuminated with CRI >90 appear to have natural and particularly saturated colours.

Gli oggetti illuminati con sorgenti CRI>90 come Hugo appaiono di colori naturali e particolarmente saturi.



SUSPENSION



WALL LAMP



CEILING LAMP



TABLE LAMP



FLOOR LAMP
p.386



Hugo

VERTICAL
DESIGN BY SLAMP CREATIVE DEPARTMENT

technical details p. 467



- 
 SUSPENSION
- 
 WALL LAMP
- 
 CEILING LAMP
- 
 TABLE LAMP
- 
 FLOOR LAMP
 p.386

Every module has a co-axis cables that create clean lines and simplified installation.

Ciascun modulo luminoso è dotato di cavo coassiale di appendamento per avere linee pulite e agevolare l'installazione,

Fabula

DESIGN BY COSTANTINO MOROSIN

technical details p. 461

SUSPENSION

AN UNENDING RIBBON

Handmade with Lentiflex®, Fabula appears to be a long, silky piece of fabric wound around itself.

Realizzata a mano concatenando elementi di Lentiflex®, Fabula ricorda una lunga e soffice fascia di seta avvolta su se stessa.



COSTANTINO MOROSIN



SUSPENSION



WALL LAMP
p.380



CEILING LAMP
p.234



TABLE LAMP



FLOOR LAMP

Ceremony

BY BRUNO RAINALDI

technical details p. 454



BRUNO RAINALDI



AN AIR OF DRAMA AND INTRINSIC WEIGHTLESSNESS

Ceremony is an opulent lamp, an ode to femininity that conjures up the image of the brush of a skirt, a pearl choker, drapery on decoltè.

Suntuoso inno alla femminilità: Ceremony è una lampada opulenta che evoca una gonna, un ballo, una collana di perle, il drappeggio di una scollatura.

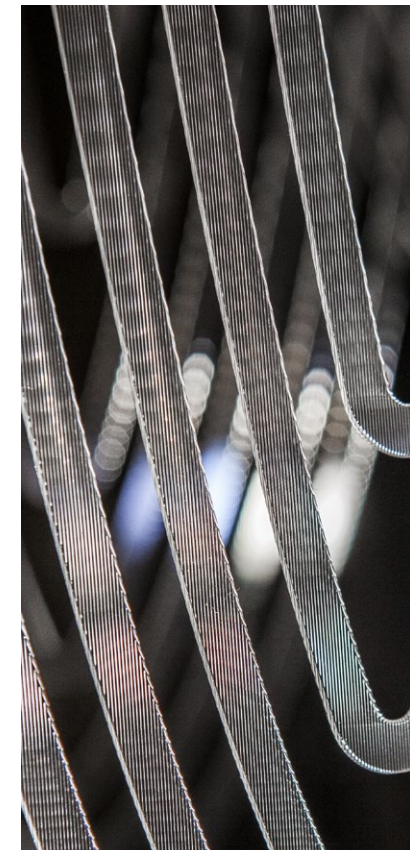

Ceremony Large Prisma

Drusa

DESIGN BY ADRIANO RACHELE

technical details p. 460



ADRIANO RACHELE

Stella Island Luxury Suites and Spa | Creta, Greece



SUSPENSION



WALL LAMP
p.366



CEILING LAMP
p.232



TABLE LAMP



FLOOR LAMP

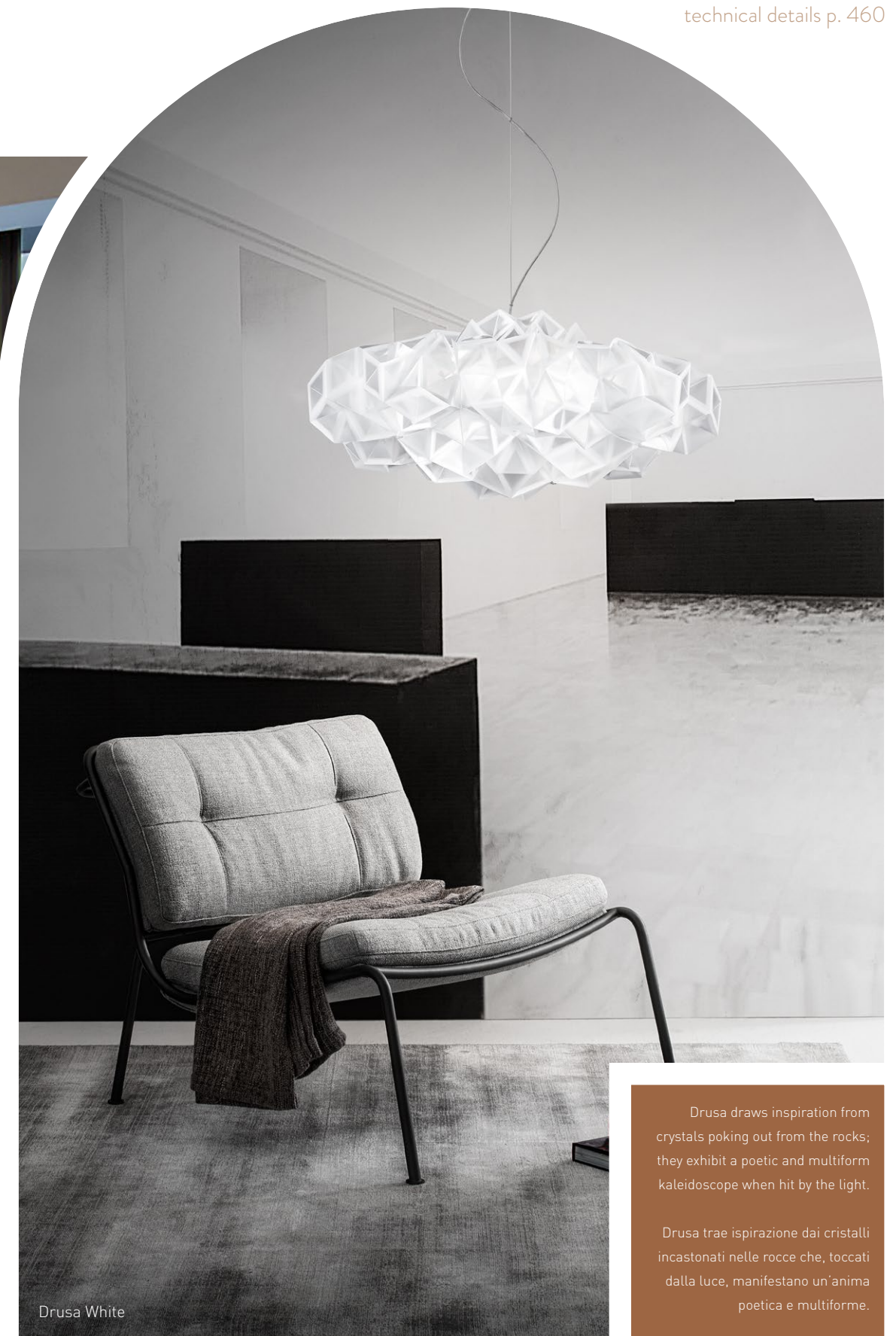

Drusa White

Drusa draws inspiration from crystals poking out from the rocks; they exhibit a poetic and multiform kaleidoscope when hit by the light.

Drusa trae ispirazione dai cristalli incastonati nelle rocce che, toccati dalla luce, manifestano un'anima poetica e multiforme.

Liza

DESIGN BY ELISA GIOVANNONI

technical details p. 472



ICONIC,
BAROQUE
INSPIRED
LAMP

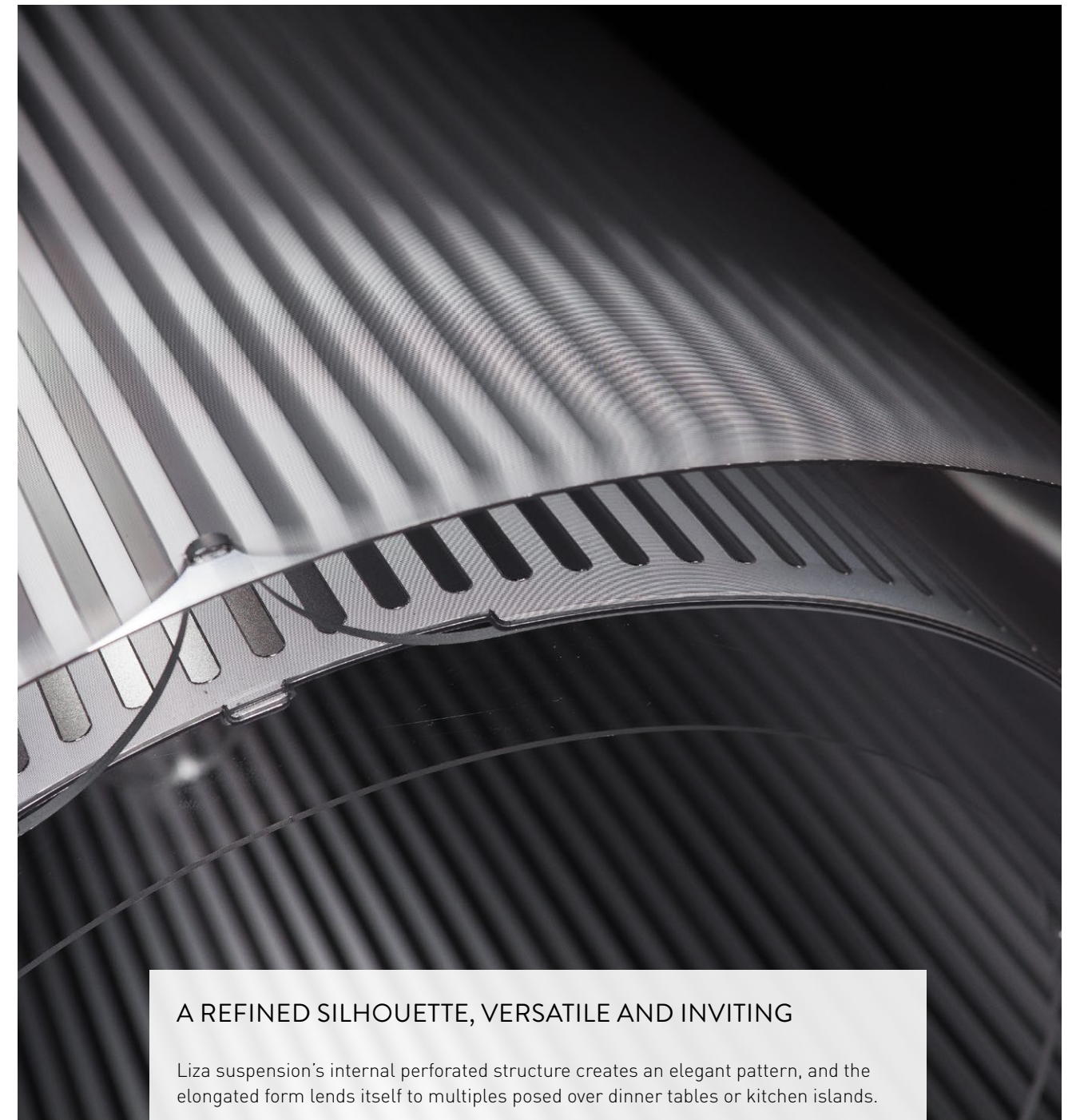

A REFINED SILHOUETTE, VERSATILE AND INVITING

Liza suspension's internal perforated structure creates an elegant pattern, and the elongated form lends itself to multiples posed over dinner tables or kitchen islands.

La struttura interna traforata crea una trama elegante nella lampada a sospensione Liza, la cui forma longilinea si presta a inserimenti multipli su un tavolo da pranzo o sulla penisola di una cucina.

Size/Dimensioni: Ø45 x 33 cm - Ø17-3/4" x h 12-3/4"

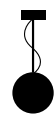

SUSPENSION



WALL LAMP



CEILING LAMP



TABLE LAMP
p.280



FLOOR LAMP
p.418

Supermorgana

DESIGN BY STEFANO PAPI

technical details p. 476

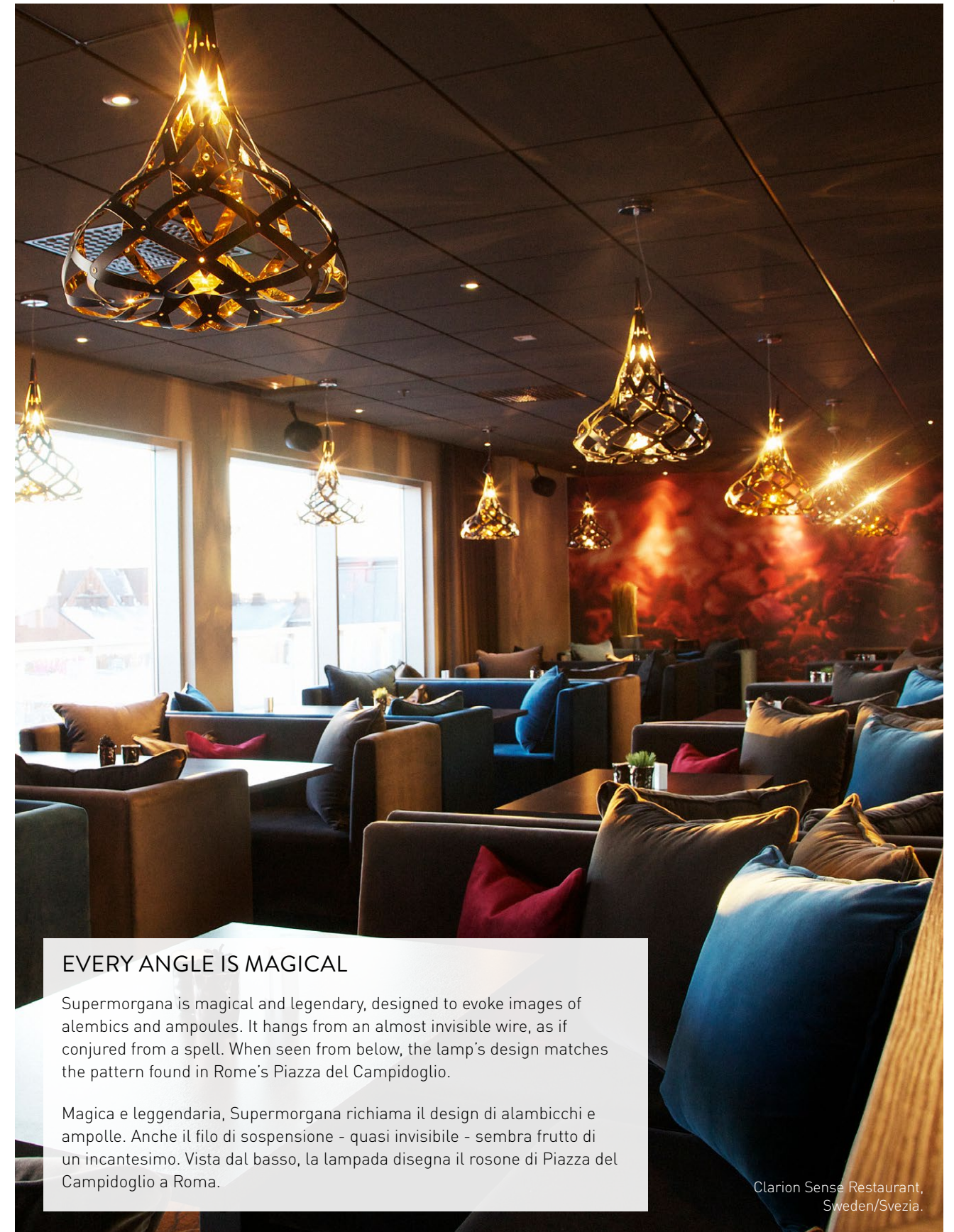

EVERY ANGLE IS MAGICAL

Supermorgana is magical and legendary, designed to evoke images of alembics and ampoules. It hangs from an almost invisible wire, as if conjured from a spell. When seen from below, the lamp's design matches the pattern found in Rome's Piazza del Campidoglio.

Magica e leggendaria, Supermorgana richiama il design di alambicchi e ampolle. Anche il filo di sospensione - quasi invisibile - sembra frutto di un incantesimo. Vista dal basso, la lampada disegna il rosone di Piazza del Campidoglio a Roma.

Clarion Sense Restaurant,
Sweden/Svezia.

Medusa

DESIGN BY NIGEL COATES

technical details p. 473

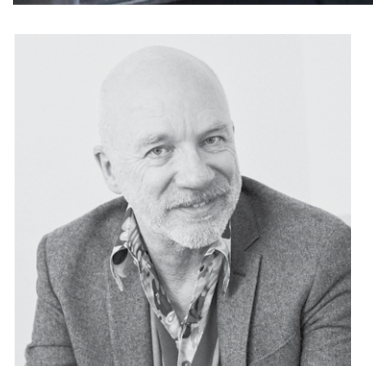

NIGEL COATES

Restaurant 1718, Deidesheim, Germany

SPANNING THE BAROQUE AND CONTEMPORARY

A Baroque-inspired lamp made of Slamp's innovative technopolymers and traditional, transparent crystals that reflect the internal light source, casting patterns abound.

Lampada d'ispirazione barocca realizzata a mano combinando i tecnopolimeri innovativi di Slamp con i tradizionali cristalli trasparenti che riflettono la luce dalla sorgente luminosa creando riflessioni multiformi tutt'intorno.



- 
 SUSPENSION
- 
 WALL LAMP
 p.384
- 
 CEILING LAMP
- 
 TABLE LAMP
- 
 FLOOR LAMP

Gemmy

BY RAGNISCO, SPALLETTA, CROCE, WIJIFFELS

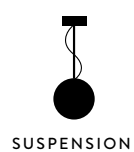

SUSPENSION



WALL LAMP



CEILING LAMP



TABLE LAMP
p.302



FLOOR LAMP

technical details p. 464

VERSATILE, REFINED FACETS FOR CONTEMPORARY INTERIORS

This versatile and dynamic collection was inspired by the polyhedral facets of desert gems. The lamp's geometries create an intriguing contemporary and refined kaleidoscope effect.

Dinamica e versatile, la collezione ispirata alle preziose gemme desertiche, con le sue poliedriche sfaccettature, avvolge la luce e genera intriganti effetti caleidoscopici.



This page/ Questa pagina:
Gemmy Gold.

Previous page/
Pagina precedente:
Gemmy multicolor
at Matisse Beach Club,
Perth, Australia.

Gemmy PRISMA

BY RAGNISCO, SPALLETTA, CROCE, WIJIFFELS

technical details p. 464

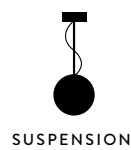
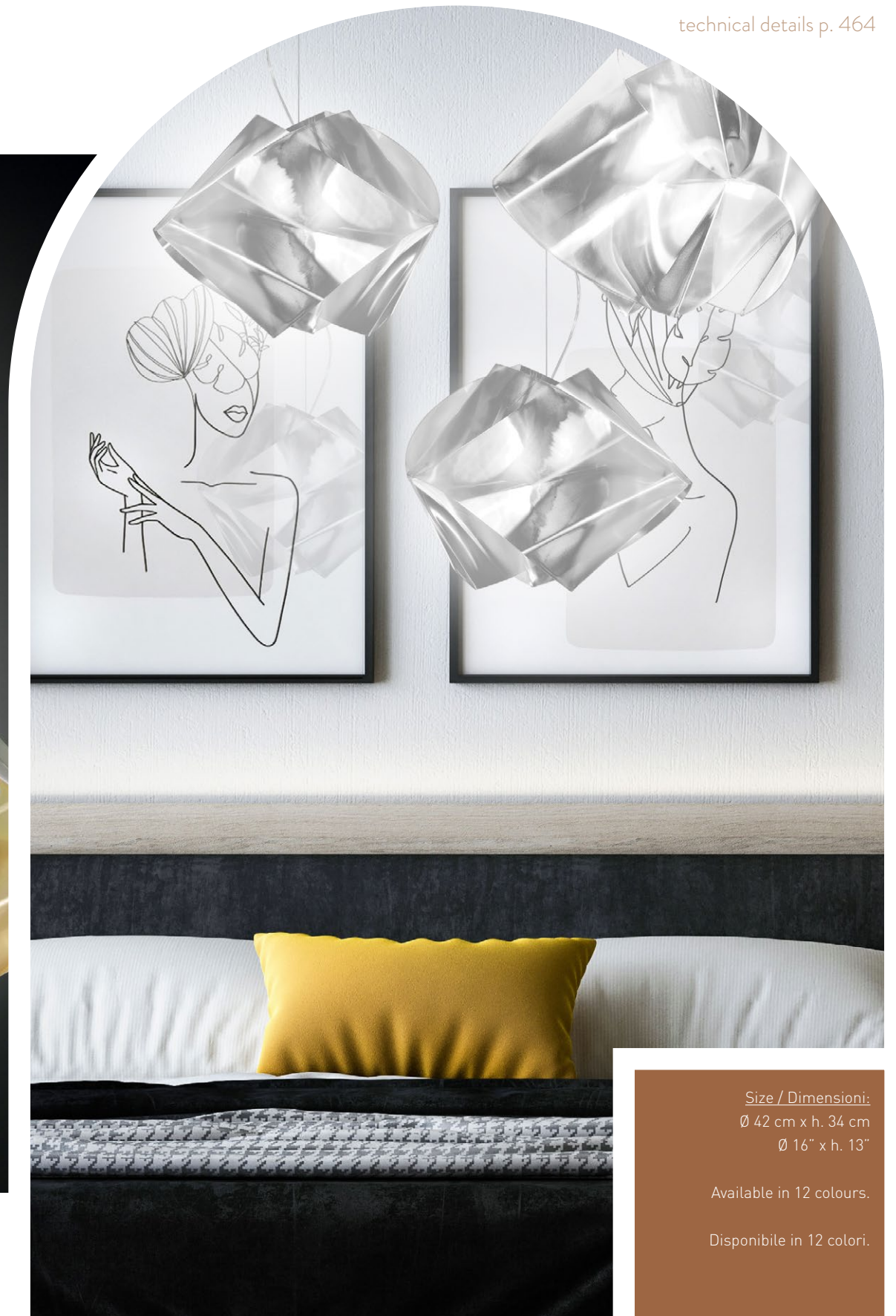

SUSPENSION



WALL LAMP



CEILING LAMP



TABLE LAMP
p.304



FLOOR LAMP
p.426

Size / Dimensioni:
Ø 42 cm x h. 34 cm
Ø 16" x h. 13"

Available in 12 colours.

Disponibile in 12 colori.

Dimple

DESIGN BY PANTONE AND PAVONCELLO

technical details p. 459



Dimple Trio Gold



SUSPENSION



WALL LAMP



CEILING LAMP



TABLE LAMP



FLOOR LAMP

SINUOUS AND SENSUAL

The exclusive cold moulding technique gives the surface a three dimensional crackle, replacing the linear shape with a unique sinuous feel.

L'esclusiva tecnica di modellazione a freddo del materiale conferisce alla superficie del prodotto una terza dimensione con un effetto crackle, in grado di spezzare la linearità della forma e renderla sinuosa e originale.



Dimple Copper detail
Dettaglio Dimple Copper



4 Dimple Single Silver



THE WARMTH OF WOOD AND VIVACIOUS COLOURS

A collection inspired by nature: the knots and veins of a tree trunk are printed on the diffuser, mixing warm tradition with vivacious colours.

Una collezione ispirata alla natura, caratterizzata dalla stampa del decoro di nodi e venature sul diffusore per mixare il calore tradizionale del legno a colori briosi e pieni di vita.

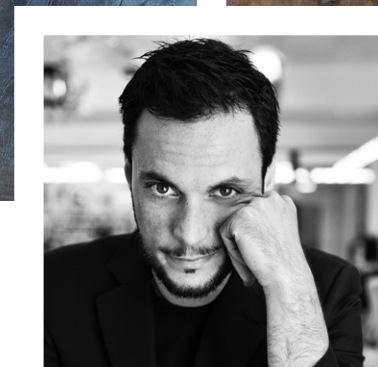

LUCA MAZZA

-  SUSPENSION
-  WALL LAMP
-  CEILING LAMP
-  TABLE LAMP
-  FLOOR LAMP

Mille Bolle

DESIGN BY ADRIANO RACHELE

technical details p. 474

SUSPENSION



A ROMANTIC, TIMELESS PLAY OF LIGHT AND WEIGHTLESS REFLECTIONS

Tiny sheets of iridescent polycarbonate are expertly folded into a charming diffusor that casts a kaleidoscope of luminous "soap bubbles".

Il fascino del diffusore, realizzato a mano piegando ad arte piccoli fogli di polycarbonato iridescente, si accende in un caleidoscopico effetto luminoso per ricreare l'emozione fugace delle bolle di sapone.

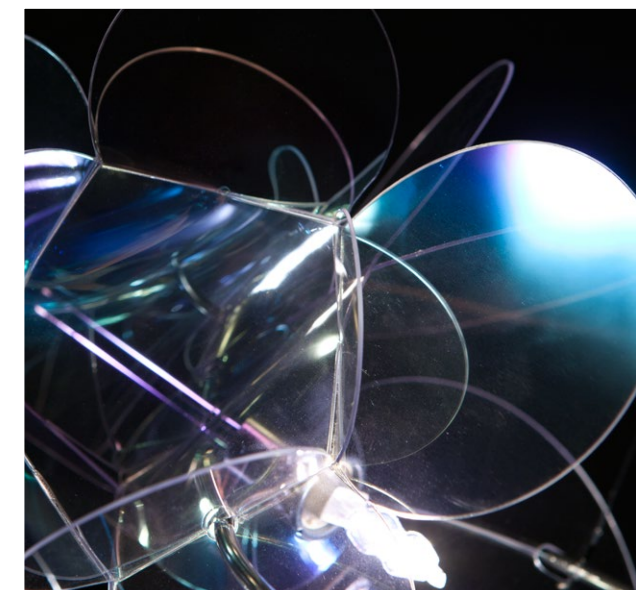

Size / Dimensione:
47 x 33 x h. 40 cm
18" x 13" x h. 15"

Lighting / Illuminazione:
1 X 6W LED G9



SUSPENSION



WALL LAMP
p.370



CEILING LAMP



TABLE LAMP
p.310



FLOOR LAMP
p.438

Atlante

DESIGN BY NIGEL COATES

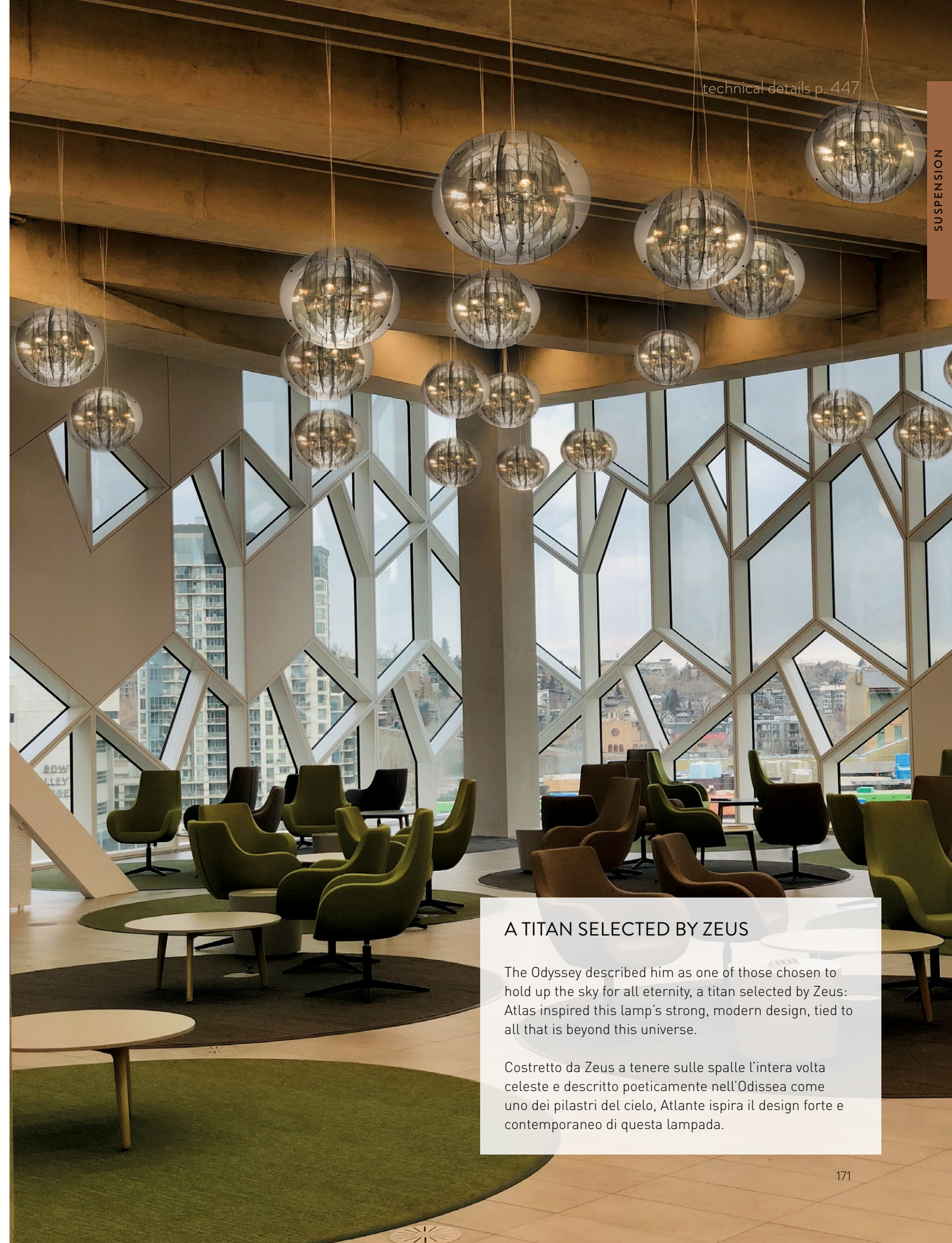

technical details p. 447

SUSPENSION

A TITAN SELECTED BY ZEUS

The Odyssey described him as one of those chosen to hold up the sky for all eternity, a titan selected by Zeus: Atlas inspired this lamp's strong, modern design, tied to all that is beyond this universe.

Costretto da Zeus a tenere sulle spalle l'intera volta celeste e descritto poeticamente nell'Odissea come uno dei pilastri del cielo, Atlante ispira il design forte e contemporaneo di questa lampada.

Ginetta

DESIGN BY NIGEL COATES



Ginetta Prisma



SUSPENSION



WALL LAMP



CEILING LAMP



TABLE LAMP



FLOOR LAMP



Ginetta Black

A CLASSIC 8-ARM CHANDELIER UNDERWENT DIGITAL EVOLUTION

Ginetta's sumptuous modern shape extends from a central light source that casts elegant, refined reflections, blending into both modern and aristocratic atmospheres. Available in five finishes; Silver, Gold, Prisma, Black or White.

Ginetta si sviluppa attorno a una fonte luminosa centrale e crea riflessi eleganti e raffinati. Si intona perfettamente alle location più attuali così come alle dimore più aristocratiche. Disponibile sia nelle versioni in Opalflex® che Silver e Prisma.

Cactus

DESIGN BY ADRIANO RACHELE

technical details p. 452

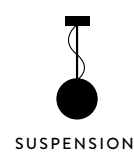

SUSPENSION



WALL LAMP

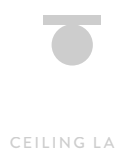

CEILING LAMP



TABLE LAMP
p.300

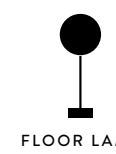

FLOOR LAMP
p.420

Cactus' ironic glow is thanks to Opalflex®, a recyclable material made of glass crystals mixed with flexible, unbreakable technopolymers.

L'ironica Cactus è realizzata in Opalflex® materiale riciclabile ottenuto miscelando cristalli di vetro a tecnopolimeri infrangibili e flessibili.



A DROP OF LIGHT

Liquid, yet compact, soft and luminous: Goccia takes note from water's weightless fluidity. The suspension's singular design reveals something unique: the light source is part of its overall aesthetic impact.

Liquida ma compatta, morbida e brillante, Goccia segue la forma fluida e leggera dell'acqua. Grazie ad un design unico, la sospensione cela e rivela la sua particolarità: la fonte luminosa che diventa parte del disegno.



STEFANO PAPI

Goccia Fire

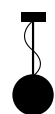

SUSPENSION



WALL LAMP



CEILING LAMP



TABLE LAMP



FLOOR LAMP

Luis

DESIGN BY ADRIANO RACHELE

technical details p. 473

SUSPENSION



Inspired by the smallest bird in the world, Luis enchants with plays of shadow and reflection, and branches that envelop the light source.

Ispirata all'uccellino più piccolo del mondo Luis incanta per i suoi giochi di ombre e riflessi creati dai tanti rami che avvolgono la fonte luminosa.

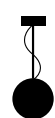

SUSPENSION



WALL LAMP



CEILING LAMP



TABLE LAMP



FLOOR LAMP

Fiorella

DESIGN BY NIGEL COATES

technical details p. 462

SUSPENSION



Size/Dimensioni:
 L: Ø76 x h. 58 cm
 (Ø29-3/4" x h. 22-3/4")
 MINI: Ø48 x h. 51 cm
 (Ø19" x h. 20")
 Available in 5 finishing.
 Disponibile in 5 colorazioni.

- 
 SUSPENSION
- 
 WALL LAMP
 p.382
- 
 CEILING LAMP
- 
 TABLE LAMP
 p.294
- 
 FLOOR LAMP
 p.430

A NEVER-ENDING BOUQUET

Suggestive, realistic and welcoming; Fiorella suspension's natural details conjure up a world covered in flora. Slamp's expressive powers and fresh figurativism meet in a flurry of reflective, luminous petals.

Realistica, avvolgente e suggestiva con i suoi naturalistici dettagli conduce l'immaginazione verso un mondo floreale dove la realtà dei piccoli cespugli arruffati di bosso incontra la magia del fresco figurativismo e delle seducenti potenzialità espressive di Slamp.



Fiorella's white Opalflex® flower detail .
Dettaglio del fiore in Opalflex® di Fiorella white.



Fiorella Suspension Mini Copper bottom view. Vista dal basso di Fiorella Suspension Mini Copper.



AN ICONIC CHANDELIER WITH CRYSTALS

The radial structure easily connects to the central Cristalflex® cylinder, that reflects the added luxury of transparent crystals.

Realizzata con una struttura radiale che si aggancia al cestello centrale in Cristalflex®, è arricchita dalla preziosità dei cristalli trasparenti.



Size / Dimensioni:
 Ø 66 cm x h. 47 cm - Ø 26" x h. 18"

Lighting / Illuminazione:
 1 X 12W LED Filament Bulb E27/E26

56 Schöler crystals
 Con 56 cristalli Schöler

Availbale in 7 finishing.
 Disponibili in 7 finiture.

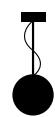

SUSPENSION



WALL LAMP
 p.378



CEILING LAMP



TABLE LAMP



FLOOR LAMP

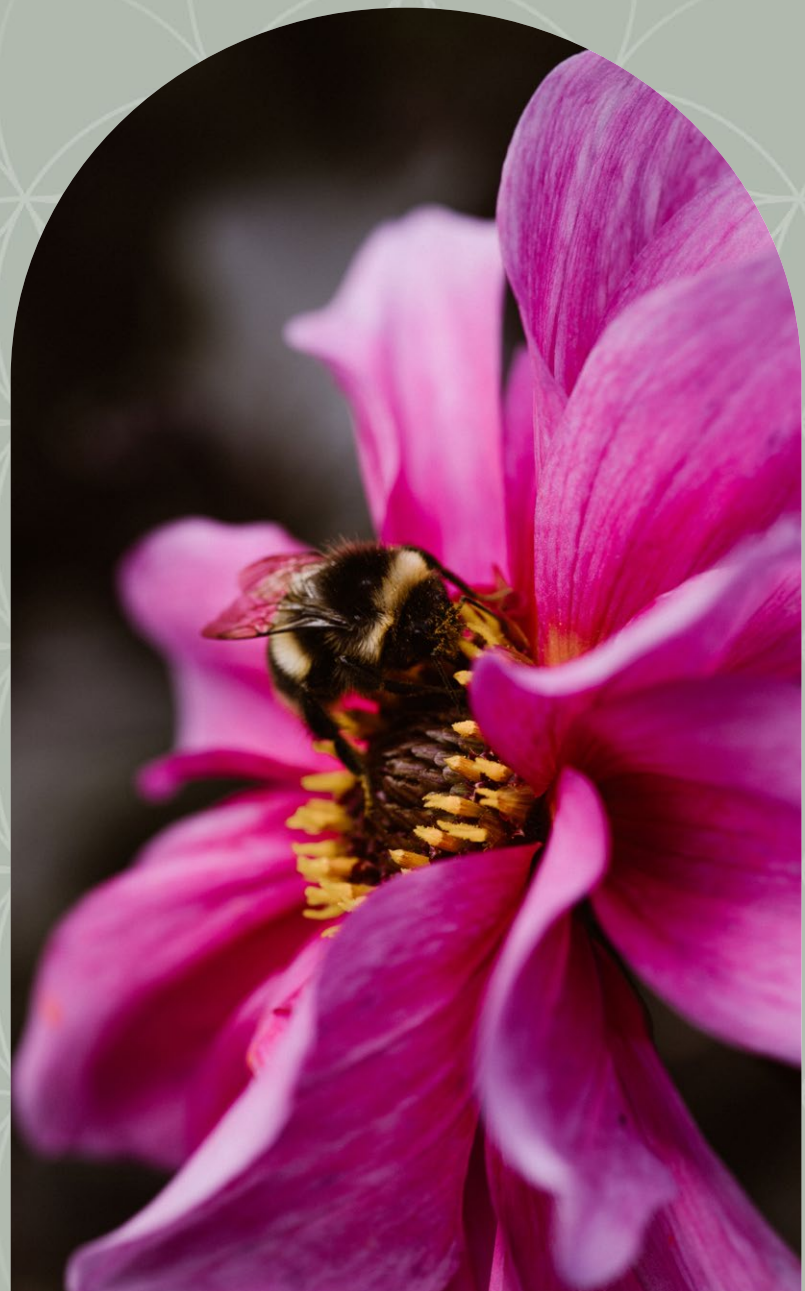

from lamps to beehives —

SLAMP'S SUSTAINABLE PROJECT

The quality of Slamp's materials and their sustainable approach to working with them has set the company apart since 1994. Their resistant, long-lasting technopolymers not only exhibit optimal thermal, electrical, and chemical properties, but these unique materials are recyclable. The manufacturing processes have a low impact on the environment: the lamps' technopolymer sheets undergo cold cutting before being constructed by hand. The small amount of extra cuttings are recycled monthly, and since the beginning of 2020, a portion of those are being made into beehives for bumblebees by DS-Group. Bumblebees, part of the Apidae family, are widely used in pollinating fruit trees (replacing toxic chemicals). They are used for tomatoes as well, and ensure quality, juicy crops. Slamp applied the same approach to their headquarters, inaugurated September 8, 2019. High priority was placed on architectural decisions, including isolating thermal materials and large windows facing the production lines to reduce the use of artificial light. The hub's energy comes from predominantly renewable sources.

Per le qualità intrinseche dei materiali che impiega, e per le tecniche di lavorazione che utilizza, Slamp è un'azienda a basso impatto ambientale sin dal 1994. I tecnopolimeri, resistenti e durevoli, sono dotati di ottime proprietà termiche, elettriche e chimiche, e – soprattutto – sono riciclabili. I pochi sfridi di lavorazione generati durante la produzione vengono riciclati da sempre ma, dal 2020, parte di essi viene utilizzata anche per la produzione di componenti di arnie per i Bombi. Questa particolare tipologia di imenotteri è fondamentale per la tutela della biodiversità e permette l'impollinazione naturale di piante da frutto e ortaggi in alternativa a prodotti chimici altamente tossici. L'attenzione e la cura dell'ambiente hanno influito anche sull'architettura della sede di Slamp inaugurata nel 2019 alle porte di Roma: parte dell'energia assorbita dall'impianto produttivo arriva da fonti rinnovabili, l'hub produttivo è stato realizzato utilizzando materiali altamente isolanti e gli ampi lucernari sulle linee di allestimento riducono il consumo di luce artificiale.

La Vie

DESIGN BY ADRIANO RACHELE

technical details p. 471



La Vie White

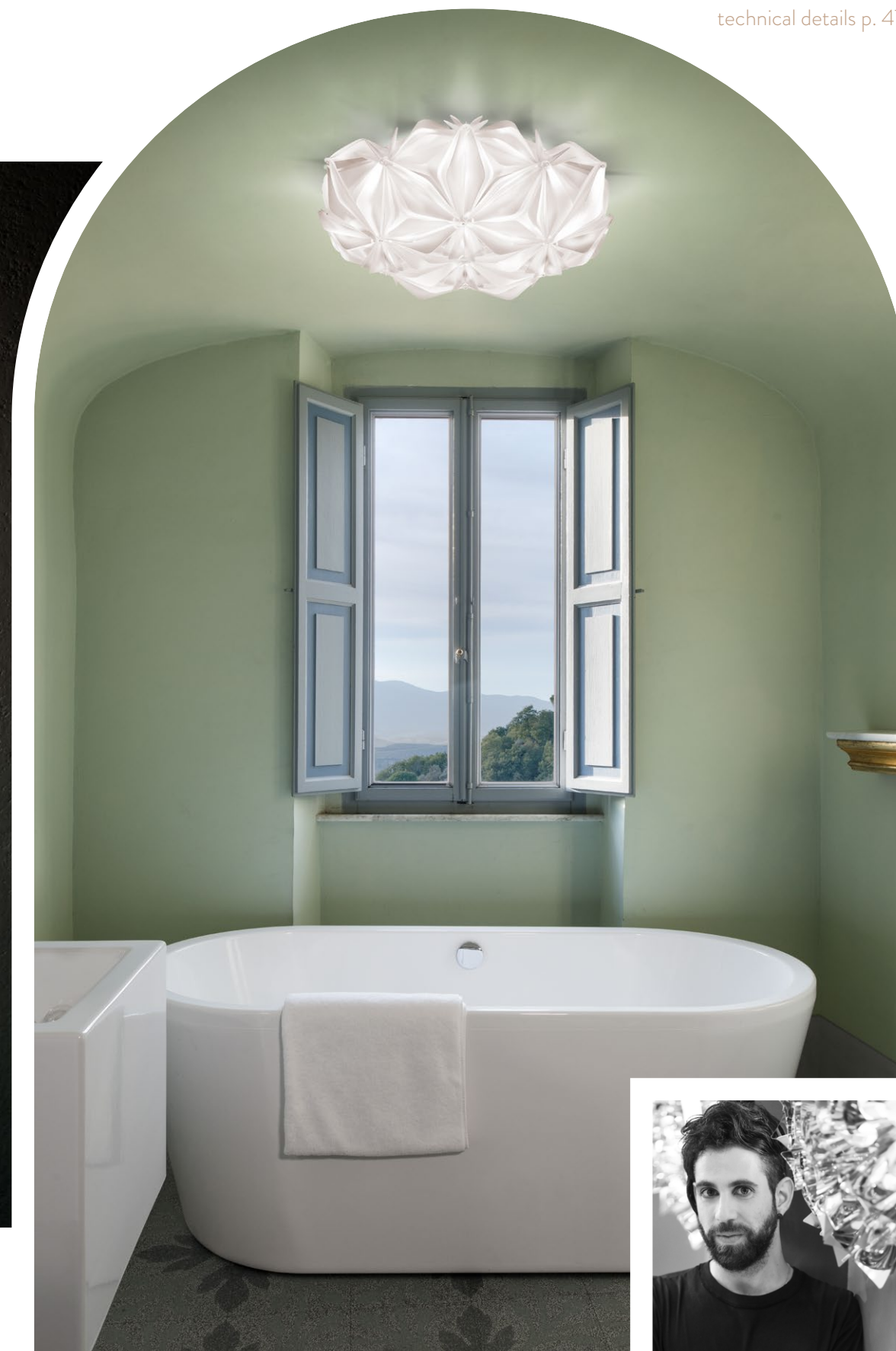

CEILING LAMP



SUSPENSION



WALL LAMP
p.338



CEILING LAMP



TABLE LAMP



FLOOR LAMP



ADRIANO RACHELE



LIVE
FOR
NOW

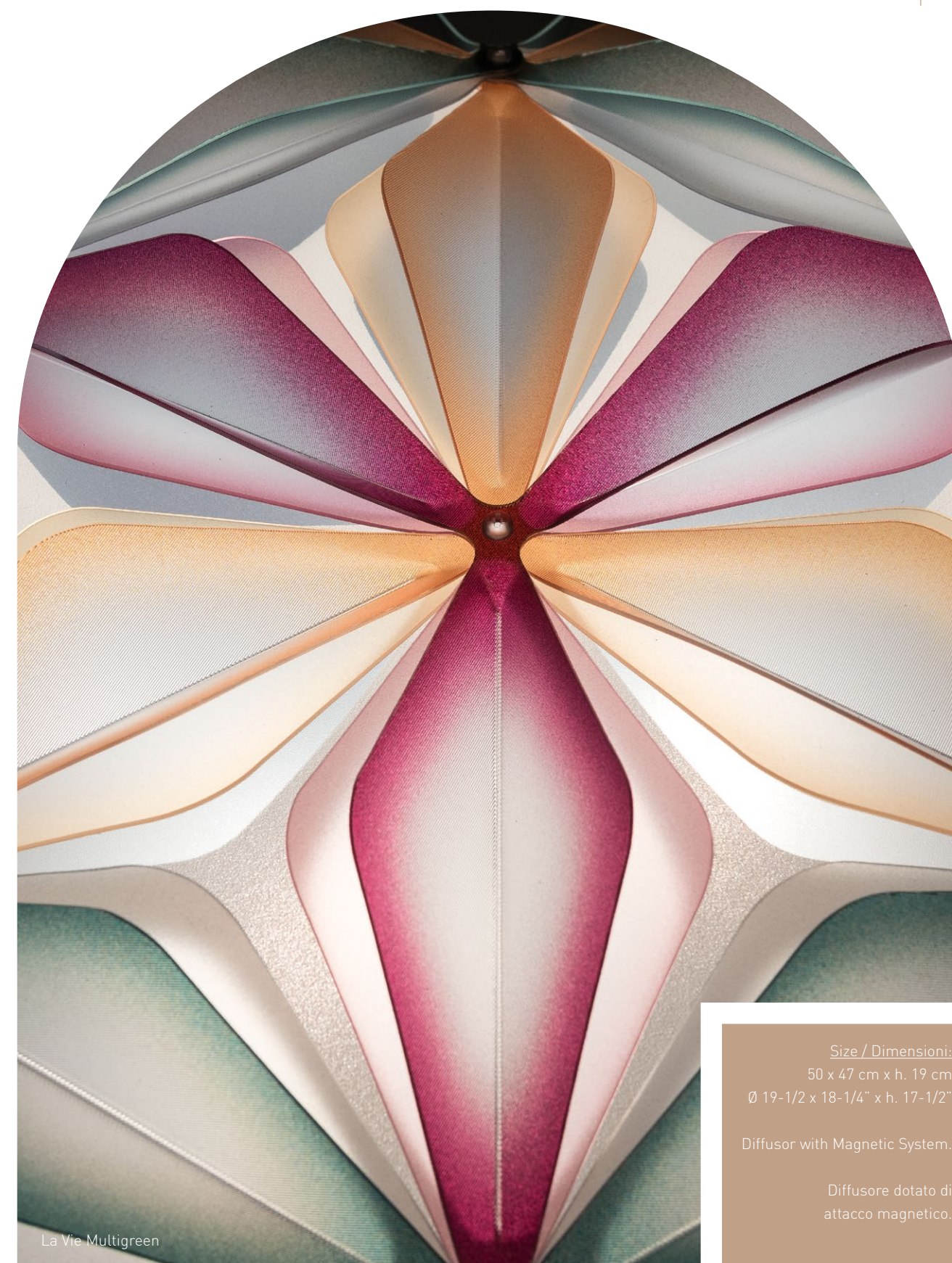

La Vie Multigreen

Size / Dimensioni:
50 x 47 cm x h. 19 cm
Ø 19-1/2" x 18-1/4" x h. 17-1/2"

Diffusor with Magnetic System.

Diffusore dotato di
attacco magnetico.

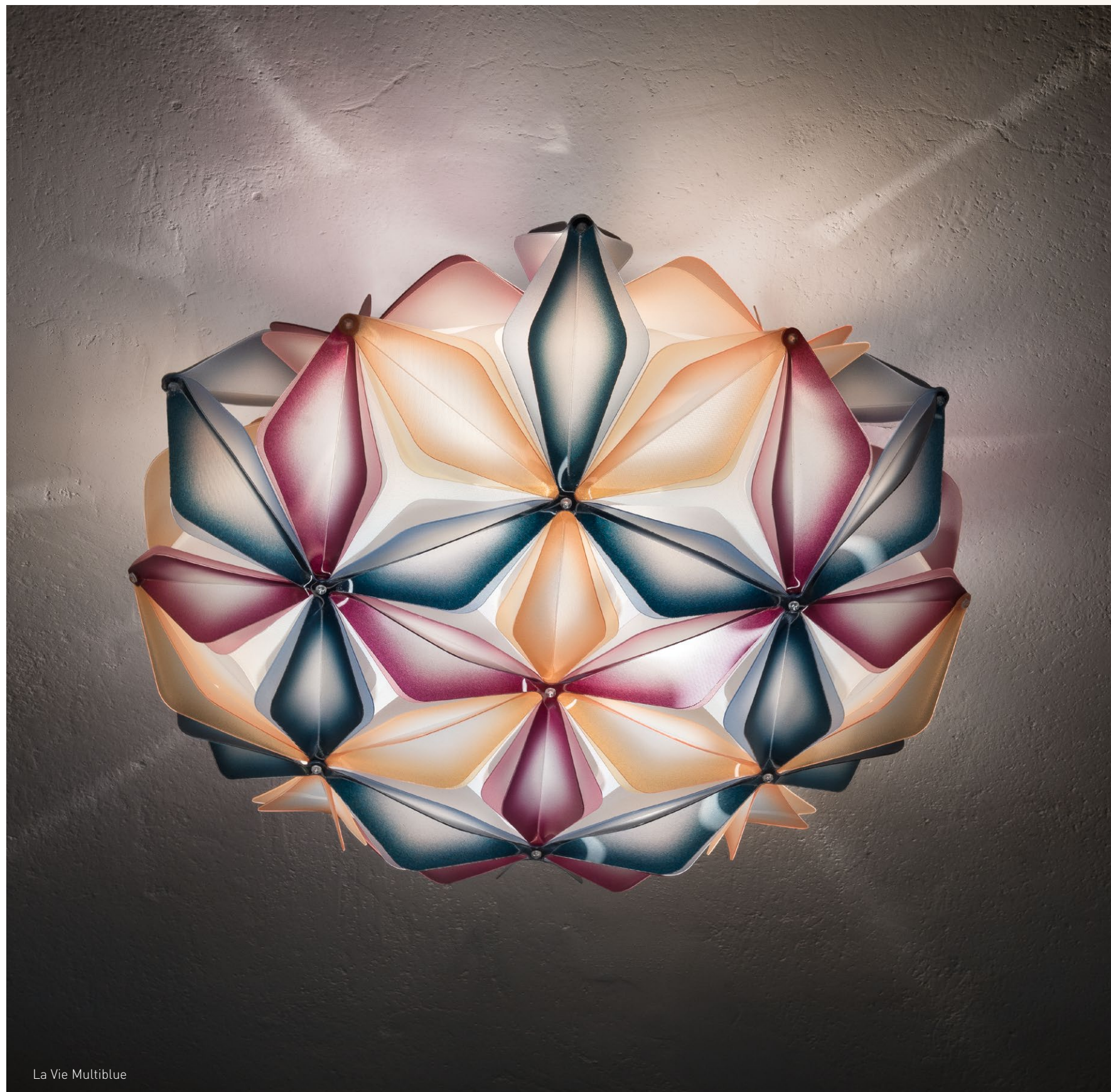

La Vie Multiblue

White

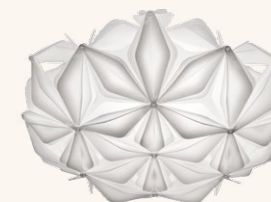

Amber

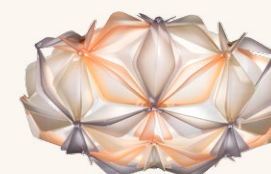

Blue

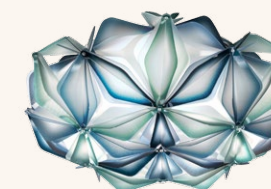

Multiblue

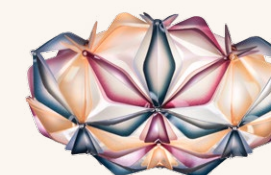

Multigreen

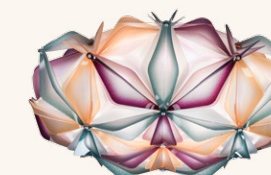

WHERE EVERYTHING EXISTS, AND EVERYTHING BEGINS

La Vie was inspired by the Flower of Life, equal to harmonious energy, a symbol of birth and beginnings, that vibrates life's frequencies. It is a three dimensional representation of all the materials in the universe, contained in a single object, the essence of everything.

Ispirata alla celebre simbologia del Fiore della Vita, La Vie è sinonimo di energia e armonia, è simbolo di inizio e di nascita, racchiude le frequenze della vita. È la raffigurazione tridimensionale di tutte le configurazioni che la materia che compone l'universo può avere. In un solo oggetto, l'essenza del tutto.

Kalatos

DESIGN BY ELISA GIOVANNONI

technical details p. 468



Kalatos Prisma

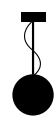

SUSPENSION
p.36



WALL LAMP



CEILING LAMP



TABLE LAMP



FLOOR LAMP



Lighting / Illuminazione:
4 x 12W - E27/E26 LED Filament Bulbs

Size / Dimensioni:
Ø 63 x h. 30 cm - 24-1/2" x h. 11-3/4"

Available in matte black with a gold interior, or white with transparent details.

Disponibile in nero opaco con interno dorato e bianco con dettagli trasparenti.

CEILING LAMP

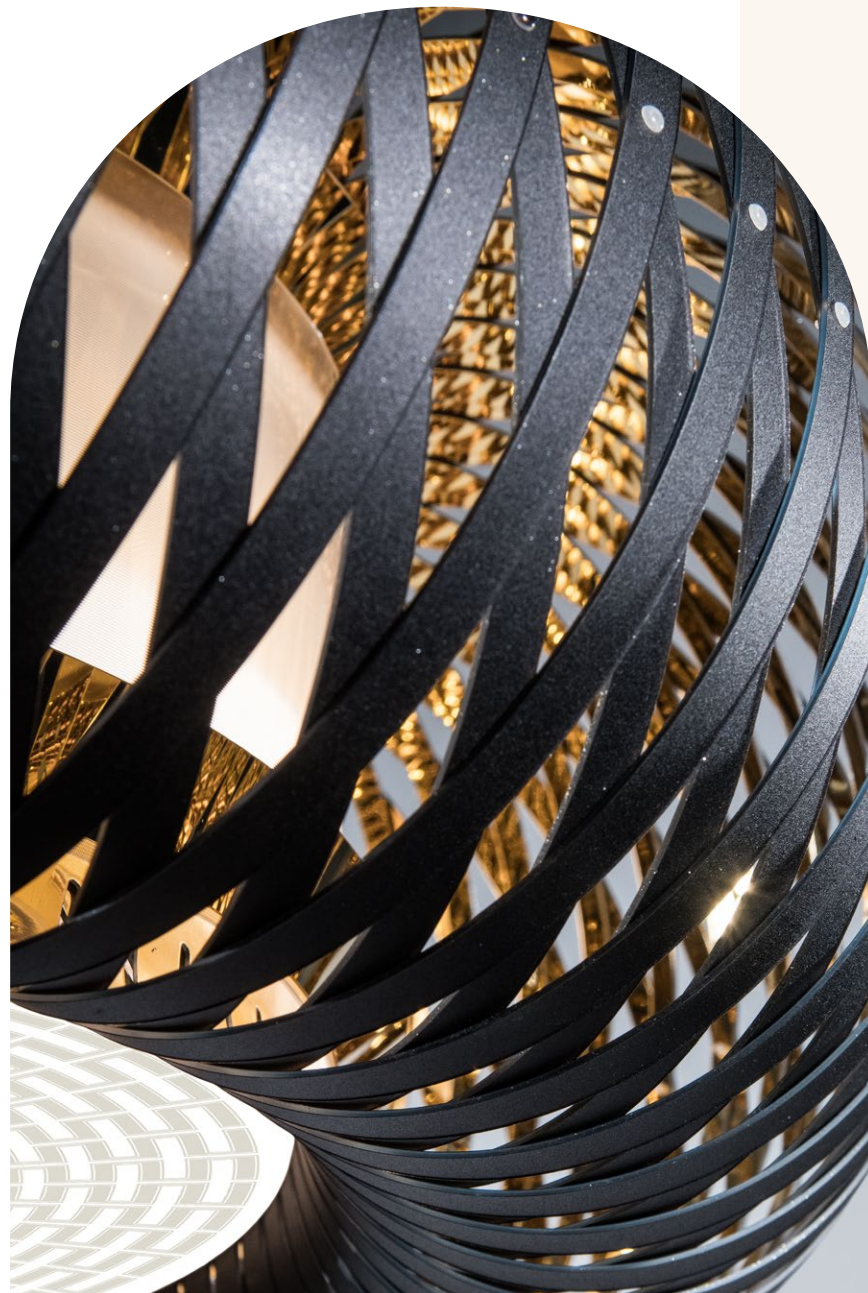

FROM PREHISTORIC ARTISANS TO CONTEMPORARY DESIGN

Kalatos was inspired by weaving, an artistic tradition that has accompanied man from prehistoric times, as vegetal fibres were braided together into baskets. The lower portion is decorated to match the diffuser's geometric pattern.

Il design di Kalatos si ispira all'arte dell'intreccio, espressione dell'artigianato artistico tradizionale che l'uomo porta con sé da quando, nella preistoria, dava vita a cesti e canestri intrecciando fibre vegetali. La parte inferiore è decorata per completare il disegno geometrico del diffusore.



Kalatos Black/Gold



elisa— giovannoni

LIGHT INFLUENCES
INSTINCTUAL EMOTIONS

I have a difficult time remembering names, but rarely forget where I saw an object, why I liked it or found it intriguing. When I began working in Ugo La Pietra's studio, my references were the masters of the Radical movement; now, I knowingly face what I see everyday with an exact idea of what I need to memorize in order to use it later, almost unwittingly, as a stimulus for new projects. Light is one of the more interesting mediums to work with as a designer, seeing as its endless expressive possibilities are limited by problems of construction. The evolution of LED technology has brought a fresh take on the act of designing; using new technology is very stimulating.

Ho una pessima memoria per i nomi, ma difficilmente dimentico dove ho visto un oggetto, perché mi piaceva o perché lo trovo strano. Quando ho iniziato, nello studio di Ugo La Pietra, i miei riferimenti erano i maestri del movimento Radicale, ora mi confronto con quello che vedo ogni giorno, consapevolmente, nel senso che so esattamente quello che devo memorizzare per poi riutilizzarne quasi inconsciamente gli stimoli progettuali. Il tema della luce è uno dei più interessanti da svolgere per un designer, sono infatti permesse molteplici possibilità espressive limitate da altrettanti problemi realizzativi. Con l'introduzione della tecnologia LED si è data nuova linfa alla progettualità: è molto stimolante progettare partendo da una nuova tecnologia.

Mida

DESIGN BY ADRIANO RACHELE

technical details p. 473



Mida Medium Multicolor



Mida Medium Amber

CEILING LAMP



SUSPENSION



WALL LAMP
p.318



CEILING LAMP



TABLE LAMP



FLOOR LAMP

Available in
5 colours and 2 sizes.
Diffusor with magnetic
hanging system.

Disponibile in
5 colori e 2 dimensioni.
Diffusore dotato di
attacco magnetico.

FROM THE WORLD OF HAUTE COUTURE JEWELS

A pavè of precious gems encrust an almost invisible setting, and polished cabochon are geometrically scattered across a floral corolla with silky, iridescent tones. Available in five color combinations, all with magnetic hanging device.

Ispirata ai pavè di pietre preziose incastonate su una struttura quasi invisibile, ai cabochon lisci e levigati che si dispongono in maniera ordinata a disegnare la corolla di un fiore dai colori cangianti e setosi. Disponibile in 5 combinazioni cromatiche, tutte con attacco magnetico.



Mida Amber detail



Mida Large White/Platinum



PLAY VIDEO

MIDA MAKES ANY ROOM EXTRA-LUXURIOUS

Veli FOLIAGE

DESIGN BY ADRIANO RACHELE

technical details p. 479



CEILING LAMP

- 
 SUSPENSION
p.102
- 
 WALL LAMP
p.352
- 
 CEILING LAMP
- 
 TABLE LAMP
p.290
- 
 FLOOR LAMP



ADRIANO RACHELE



AESTHETICS MEET LUSH, DECORATIVE DETAILS

A series of handcrafted elements delicately connect to create sinuous, elegant design. Veli's selection of colours and versions add versatile richness to diverse interiors.

Tramite un sistema di incastrati eseguiti a mano, Veli si articola in un design sinuoso ed elegante capace di valorizzare ogni interior.



reddot design award
honourable mention 2012



Integrated magnetic
hanging system.
Ceiling version available
in 3 sizes.

Dotata di attacco magnetico.
Plafoniera disponibile
in 3 misure.

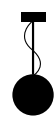

SUSPENSION
p.106



WALL LAMP
p.354



CEILING LAMP



TABLE LAMP
p.292



FLOOR LAMP



THE LIQUIDITY OF LENTIFLEX®

Lentiflex® 's Fresnel effect gives the light sources a fluid effect and creates a profound depth that transmits the liquidity of a shining waterfall.

L'effetto Fresnel del Lentiflex® permette di "fluidificare" la luce fino a riprodurre la sensazione della fluidità di una cascata d'acqua luminosa.



Integrated magnetic system facilitates cleaning and maintenance

Attacco magnetico per una veloce pulizia e manutenzione

Veli Large Prisma

- 
SUSPENSION
 p.112
- 
WALL LAMP
 p.358
- 
CEILING LAMP
- 
TABLE LAMP
- 
FLOOR LAMP

Veli

GOLD/SILVER/COPPER
DESIGN BY ADRIANO RACHELE

technical details p. 478



Veli Medium Silver



Veli Medium Gold



SUSPENSION
p.110



WALL LAMP
p.360



CEILING LAMP



TABLE LAMP



FLOOR LAMP



Veli Copper Collection at Erwin Restaurant, Moscow, Russia.

CEILING LAMP

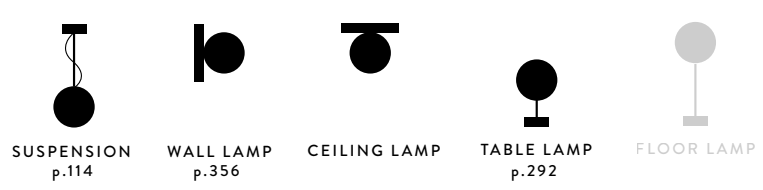



adriano — rachele

LIGHT IS POETRY

I have always worked with light, and it is the only element that gives a visible "soul" to any object, bringing it both warmth and magic. The most gratifying part of being a designer is losing myself in a creative universe where a product begins as a mere figment of my imagination, and transforms into something I can build, see and touch. Hopper stated, "All I wanted to do was paint sunlight on a house wall". I work by modeling surprising shapes that cast poetic reflections when they encounter light.

Lavoro con la luce da sempre, è l'unico elemento che dà un'anima visibile agli oggetti, aggiungendogli calore e magia. Perdermi nell'universo creativo fino a realizzare, vedere e toccare ciò che fino a quel momento potevo solo immaginare è la parte più gratificante del mio essere designer. Citando Hopper "Quello che vorrei dipingere è la luce del sole sulla parete di una casa", lo faccio modellando forme che creano stupore e che fanno godere della poesia del riflesso che producono quando incontrano la luce.

Clizia

MAMA NON MAMA
DESIGN BY ADRIANO RACHELE

technical details p. 456



Small Ø32



Medium Ø53



Large Ø78



SUSPENSION
p.70



WALL LAMP
p.346



CEILING LAMP



TABLE LAMP
p.272



FLOOR LAMP



Clizia Large Mama Non Mama

CEILING LAMP

Clizia PIXEL

DESIGN BY ADRIANO RACHELE

technical details p. 456



CEILING LAMP

Integrated magnetic hanging system.
Dotata di attacco magnetico.

Available in 3 sizes.
Disponibile in 3 misure.

L: Ø78 x h.25 cm - Ø30 3/4" x h.9-3/4"
M: Ø53 x h.20 cm - Ø20 3/4" x h.8"
MINI: Ø32 x h.15 cm - Ø12 1/2" x h.5 3/4"

Clizia Large Pixel

A GREEK NYMPH
TRANSPORTED
TO THE DIGITAL AGE

- 
SUSPENSION
p.74
- 
WALL LAMP
p.348
- 
CEILING LAMP
- 
TABLE LAMP
- 
FLOOR LAMP



Clizia Large Fumé

TRANSFORM SPACES INTO LANDSCAPES

The lamp draws on natural forms, resembling a cloud that captures the first changing rays of morning sun, or a treetop filtering a play of lights and shadows.

La lampada riprende le forme della natura: è una nuvola che cattura la luce del sole delle prime ore del giorno e si carica di riflessi cangianti, è la chioma di un albero attraverso la quale la luce filtra e crea giochi con le ombre.

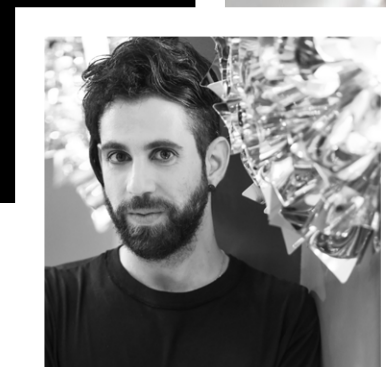

ADRIANO RACHELE

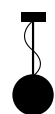

SUSPENSION
p.76



WALL LAMP
p.350



CEILING LAMP



TABLE LAMP
p.274



FLOOR LAMP
p.416

Clizia

DESIGN BY ADRIANO RACHELE

technical details p. 456



CLIZIA TAKES NOTE OF NATURAL FORM

Clizia's shapes fit together to create a perfect balance of reflections and transparencies, and features an integrated magnetic system to facilitate installation and maintenance.

Forme regolari incastrate in un perfetto equilibrio di trasparenze e riflessi compongono il design di Clizia. Dotata di un supporto magnetico che agevola installazione e pulizia.



CEILING LAMP

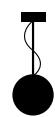

SUSPENSION
p.78



WALL LAMP
p.356



CEILING LAMP



TABLE LAMP
p.278



FLOOR LAMP
p.416

Hanami

DESIGN BY ADRIANO RACHELE

technical details p. 465

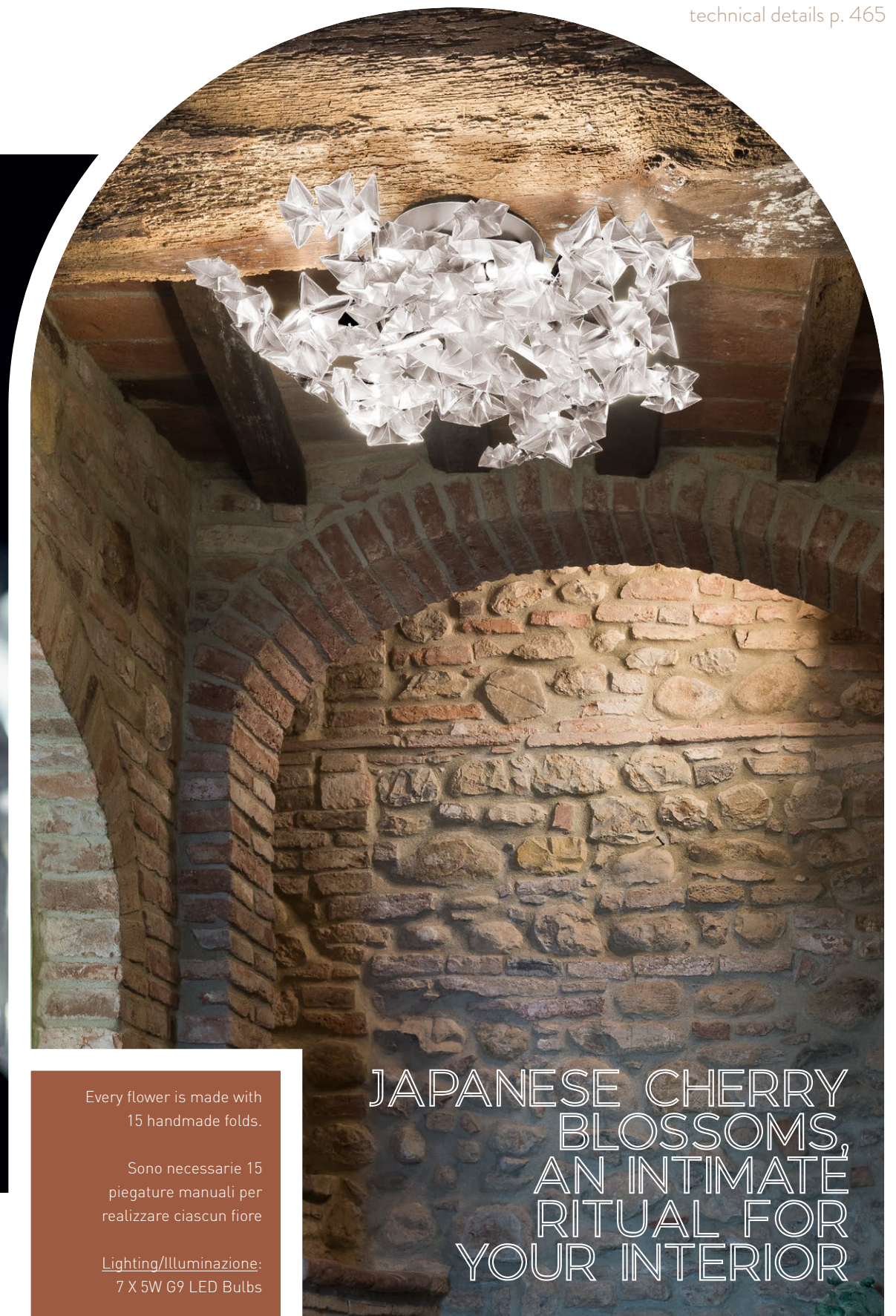

CEILING LAMP

Every flower is made with
15 handmade folds.

Sono necessarie 15
piegature manuali per
realizzare ciascun fiore

Lighting/Illuminazione:
7 X 5W G9 LED Bulbs

JAPANESE CHERRY
BLOSSOMS,
AN INTIMATE
RITUAL FOR
YOUR INTERIOR

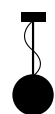

SUSPENSION
p.124



WALL LAMP
p.344



CEILING LAMP



TABLE LAMP



FLOOR LAMP

La Belle Étoile

DESIGN BY ADRIANO RACHELE

technical details p. 469



INSPIRED BY THE SOFT FLOUNCE OF A TUTU

The unbreakable yet almost weightless lamp is completely handcrafted in Slamp's atelier, with a soft, luminous LED source that can be dimmed.

La lampada, infrangibile, leggera, realizzata interamente a mano nell'atelier di Slamp, è dotata di una sorgente a LED sostituibile e dimmerabile.

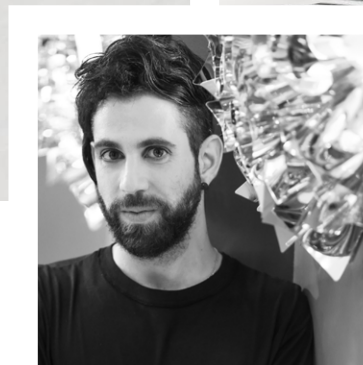
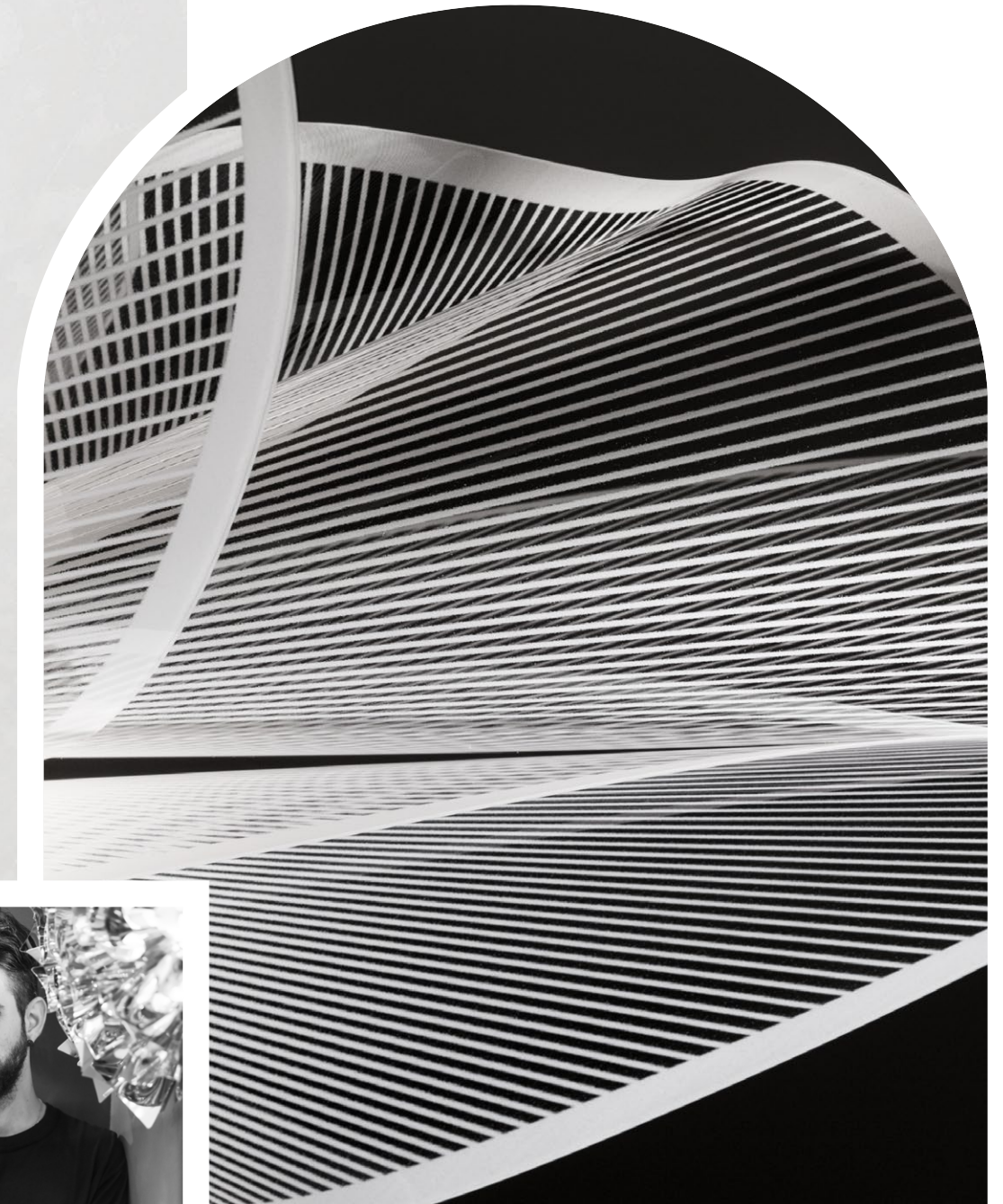

ADRIANO RACHELE



SUSPENSION
p.94



WALL LAMP
p.362



CEILING LAMP



TABLE LAMP



FLOOR LAMP

Étoile

DESIGN BY ADRIANO RACHELE

technical details p. 460

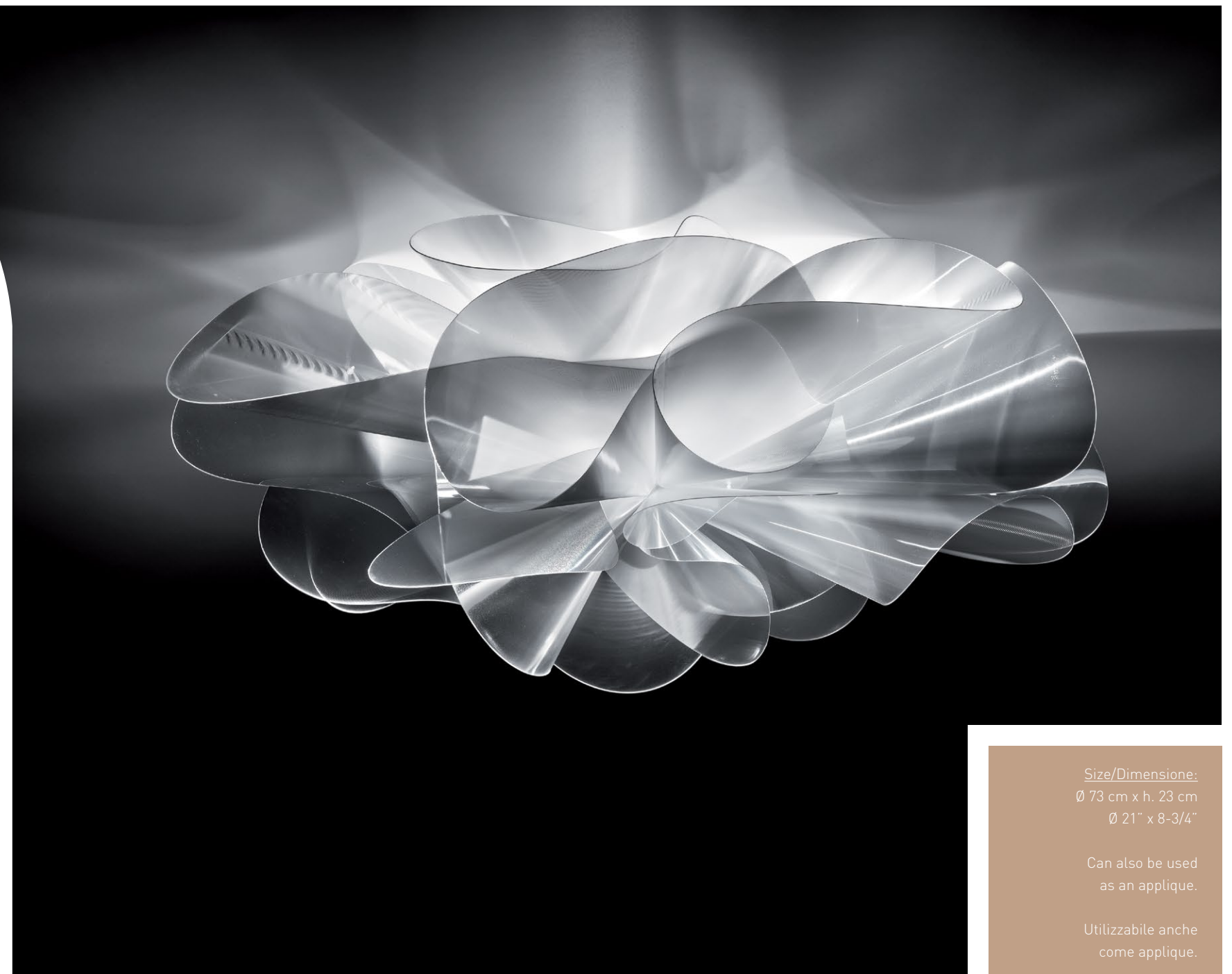
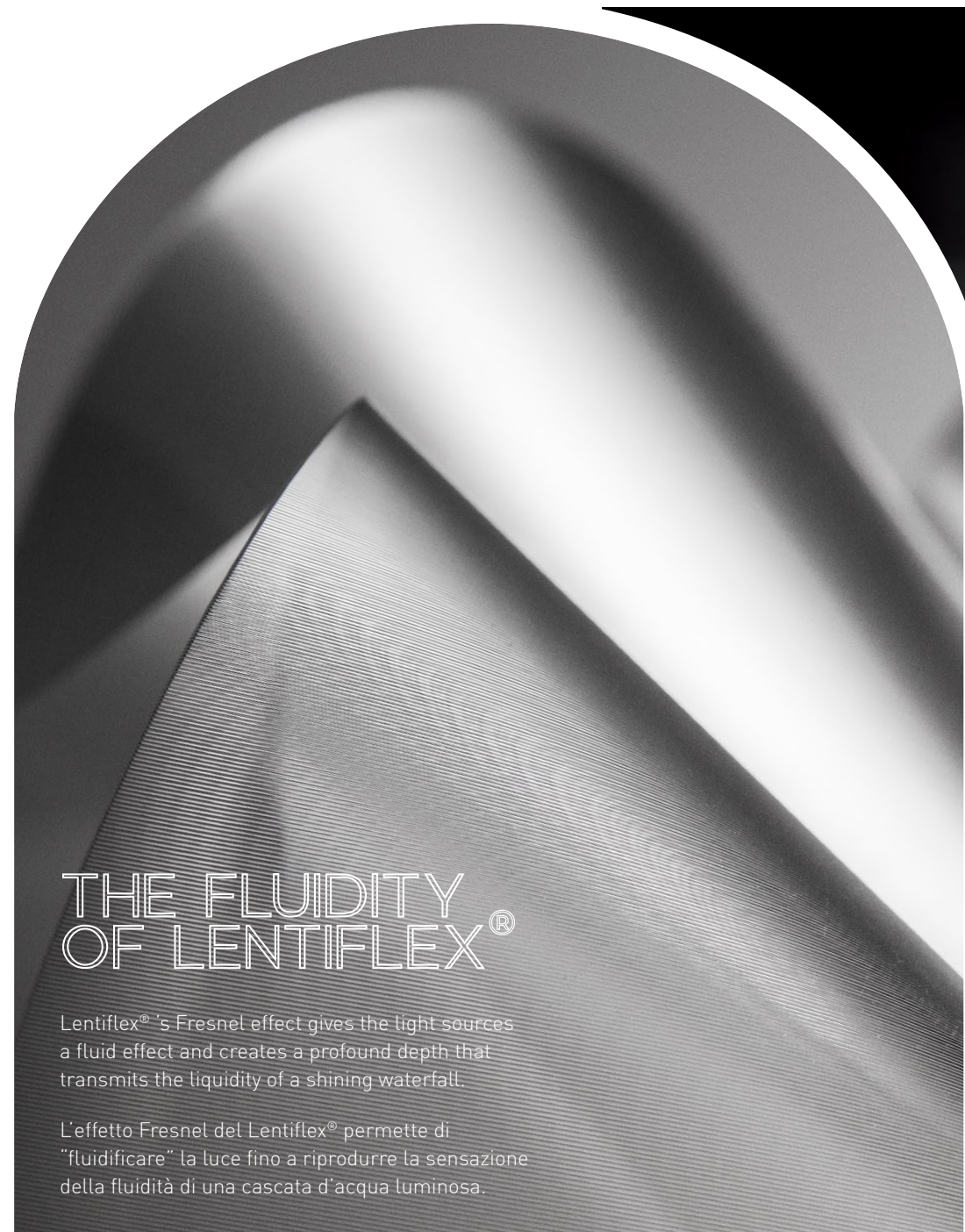

Size/Dimensione:
Ø 73 cm x h. 23 cm
Ø 21" x 8-3/4"

Can also be used
as an applique.

Utilizzabile anche
come applique.

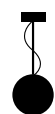

SUSPENSION
p.98



WALL LAMP
p.364



CEILING LAMP



TABLE LAMP



FLOOR LAMP

Drusa

DESIGN BY ADRIANO RACHELE

technical details p. 460



Drusa Velvet

LIKE CRYSTALS POKING OUT FROM THE ROCKS

Drusa, resembling a diamond, is available in suspension and ceiling versions, and with its infinite chromatic shades, brings a fresh, trendy feel to any space.

Sia in versione plafoniera/ applique che a sospensione, che richiama l'immagine di un diamante, Drusa conferisce agli ambienti un sapore fresco e trendy, perfetta per illuminare con carattere in tutte le sue sfumature cromatiche.

Size / Dimensioni:
Ø 60 cm x 20 cm
Ø 23-1/2" x h. 8"

Lighting / Luce:
4 X 12W E27/E26
LED Filament Bulbs



PLAY VIDEO



Drusa White

CEILING LAMP

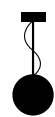

SUSPENSION
p.152



WALL LAMP
p.366



CEILING LAMP



TABLE LAMP



FLOOR LAMP

Fabula

DESIGN BY COSTANTINO MOROSIN

technical details p. 462

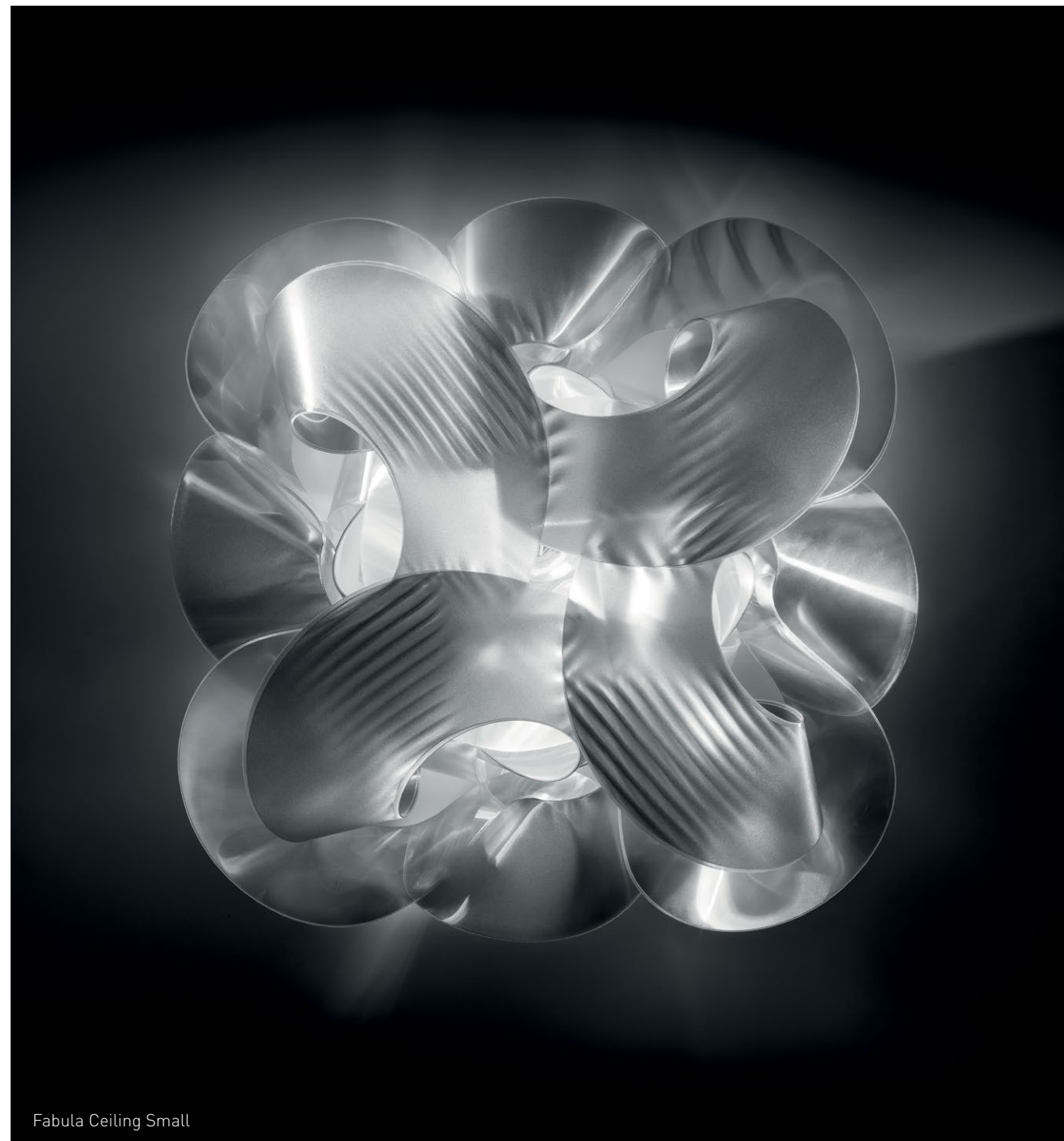

Fabula Ceiling Small

A LONG, SILKY PIECE OF FABRIC

Fabula imitates a long, silky piece of fabric knotted around itself. The material's iridescent effects flash thanks to the 60 cm. diameter body's 5 central light sources.

Realizzata a mano concatenando elementi di Lentiflex®, Fabula ricorda una lunga e soffice fascia di seta avvolta su se stessa. Nella versione da 60 cm di diametro, l'effetto cangiante del materiale è reso più scintillante dalle 5 fonti luminose.

Large: Ø 60 cm x 25cm
Ø 23-1/2" x h. 9 -3/4"
5 X 12W E27/E26
LED Filament Bulbs

Small: Ø 48,5 cm x 21cm
Ø 19" x h. 8"
3 X 12W E27/E26
LED Filament Bulbs



COSTANTINO MOROSIN



SUSPENSION
p.148



WALL LAMP
p.380



CEILING LAMP



TABLE LAMP



FLOOR LAMP

Aurora

DESIGN BY NIGEL COATES

technical details p. 448

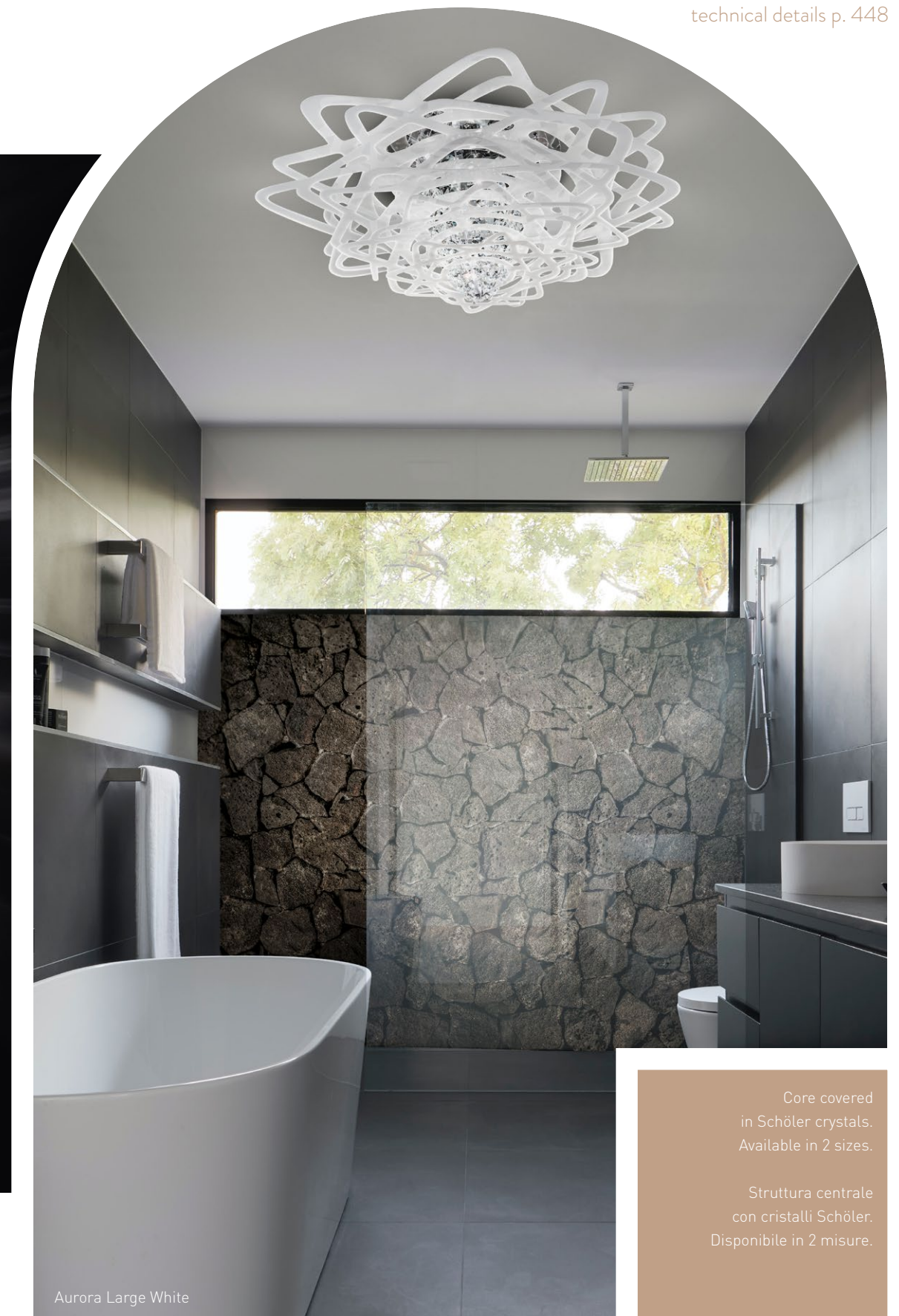

CEILING LAMP

- 
 SUSPENSION
- 
 WALL LAMP
- 
 CEILING LAMP
- 
 TABLE LAMP
- 
 FLOOR LAMP

Core covered
in Schöler crystals.
Available in 2 sizes.

Struttura centrale
con cristalli Schöler.
Disponibile in 2 misure.

Bios

DESIGN BY NIGEL COATES

technical details p. 451

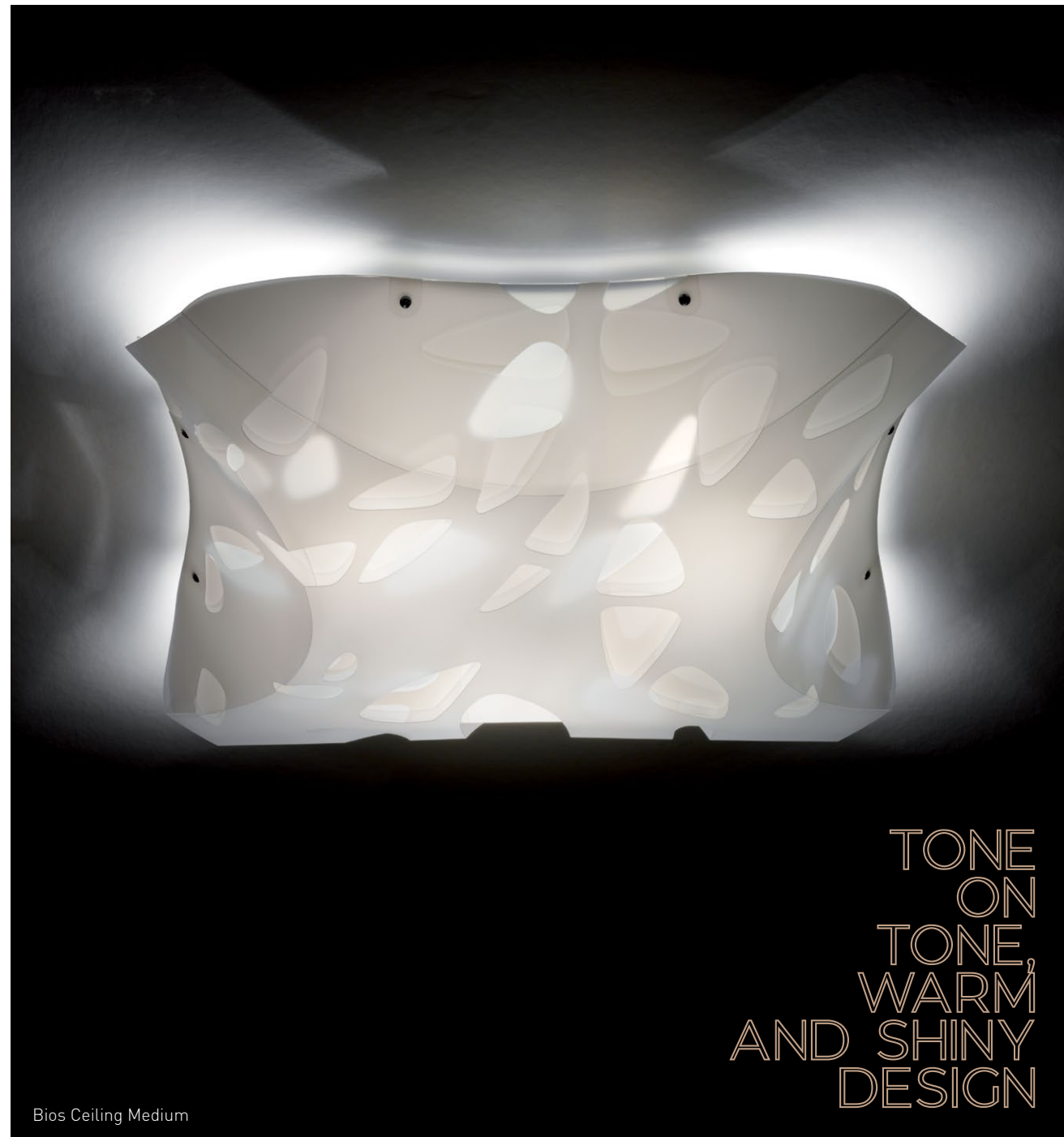

CEILING LAMP



SUSPENSION



WALL LAMP
p.372



CEILING LAMP



TABLE LAMP
p.316



FLOOR LAMP
p.434

Dafne

DESIGN BY NIGEL COATES

technical details p. 458

SPROUTED TO A LAUREL LEAF

A nymph transformed into a tree:
the myth and images that inspired
the name.

Il nome della lampada porta con sé
l'immaginario mitico della trasformazione
della Ninfa da donna in arbusto.

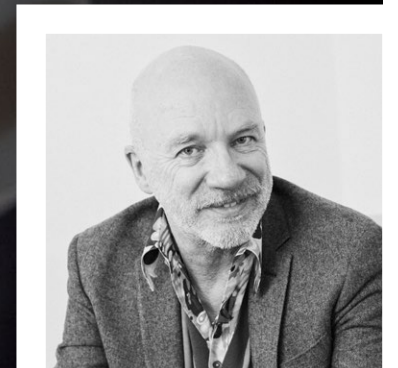

NIGEL COATES

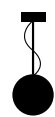

SUSPENSION
p.160



WALL LAMP
p.376



CEILING LAMP



TABLE LAMP
p.314



FLOOR LAMP
p.432



alessandro — mendini

AN UNDEFINED MAZE

Maestro Alessandro Mendini was Slamp's first Art Director in 1994. He taught all about curious design, filled with eclectic irony. His semantic universe is built around people and emotions, and he notes that our actions speak of our lives, design being nothing more than a witness to our daily tragic comedies. He sees the home as a sum of greater parts, a puzzle, and a mosaic of objects where furnishing sets a private stage for the accumulation of memories. He left his fingerprints on aesthetic language, and we are infinitely grateful for the Light he brought us.

Il Maestro Alessandro Mendini – primo Art Director di Slamp nel 1994 – ci ha insegnato a progettare all'insegna della curiosità, dell'ecllettismo e dell'ironia. Il suo universo semantico è costruito intorno all'emozione e alla persona, "perché le nostre attività parlano di noi e la progettazione non è altro che introdurre testimonianze nella 'tragicommedia della vita". Nella sua visione, la casa ideale è una insieme, un puzzle, un mosaico di oggetti, dove "l'arredamento diventa il teatro della vita privata, quella scena, sommatoria di immagini e di ricordi, dove ogni cosa è finalizzata a creare la "casa palcoscenico". A lui, che ha lasciato la sua stella nella costellazione dei linguaggi estetici, il nostro più amorevole ringraziamento per averci dato alla Luce.

Venti

DESIGN BY ALESSANDRO MENDINI

technical details p. 480

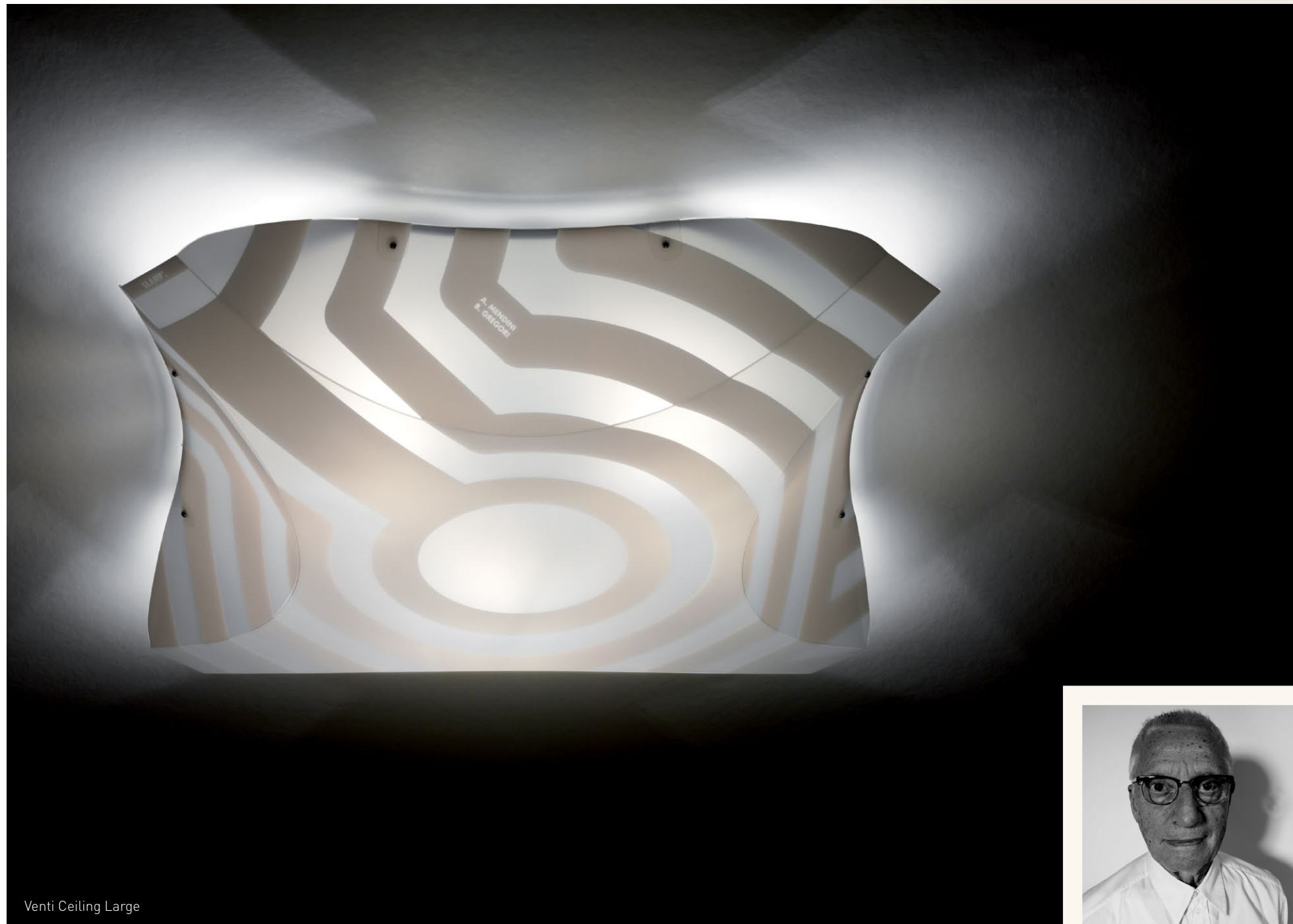

Venti Ceiling Large



ALESSANDRO MENDINI

LIKE A STONE THROWN INTO WATER...

Like a stone thrown into water, the lamp's lines are soft and uniform; concentric circles that surround the central light sources radiate outwards.

Come un sasso gettato nell'acqua, il decoro che la caratterizza genera linee morbide e regolari: cerchi concentrici, sempre più grandi, in corrispondenza delle fonti luminose.



CEILING LAMP



SUSPENSION



WALL LAMP
p.374



CEILING LAMP



TABLE LAMP
p.308



FLOOR LAMP
p.436

Accordéon

DESIGN BY MARC SADLER

technical details p. 446



PLEATED
DIFFUSOR
AND DUAL
ILLUMINATION

TABLE LAMP

-  SUSPENSION p.30
-  WALL LAMP
-  CEILING LAMP
-  TABLE LAMP
-  FLOOR LAMP

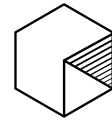

archiproducts
DESIGN AWARDS
—
WINNER 2020

The diffuser is hand moulded by Slamp's artisans, making each unique. It can be easily removed for cleaning and maintenance. Dual lighting in the main source and base allows for either individual or collective illumination. The base's steel plate proudly authenticates "Handmade in Italy".

Il diffusore - rimovibile per una facile pulizia - è scaldato e modellato a mano dalle Sarte della Luce per creare pezzi unici mai identici tra loro. La doppia accensione permette di tenere accesi diffusore e base sia singolarmente che contemporaneamente. La barretta in acciaio al lato della base riporta la dicitura "Handmade in Italy".



PLAY VIDEO

DUAL POSITION ILLUMINATION

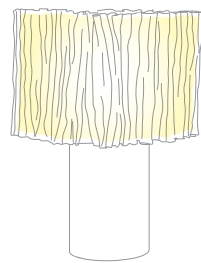

SHADE ON

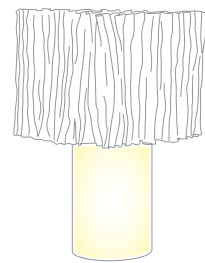

BASE ON

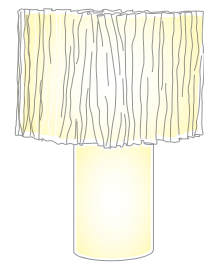

SHADE AND BASE ON



Size / Dimensione:
Ø37 x h. 48 cm
Ø14-1/2" x h. 18-3/4"

Lithing / Illuminazione:
2 X 12W E27 / E26 LED bulbs
in the shade and an independent
E14 / E12 bulb in the base.

2 lampadine X 12W E27 / E26
LED nel diffusore
e una E14 nella base, con
accensione indipendente.

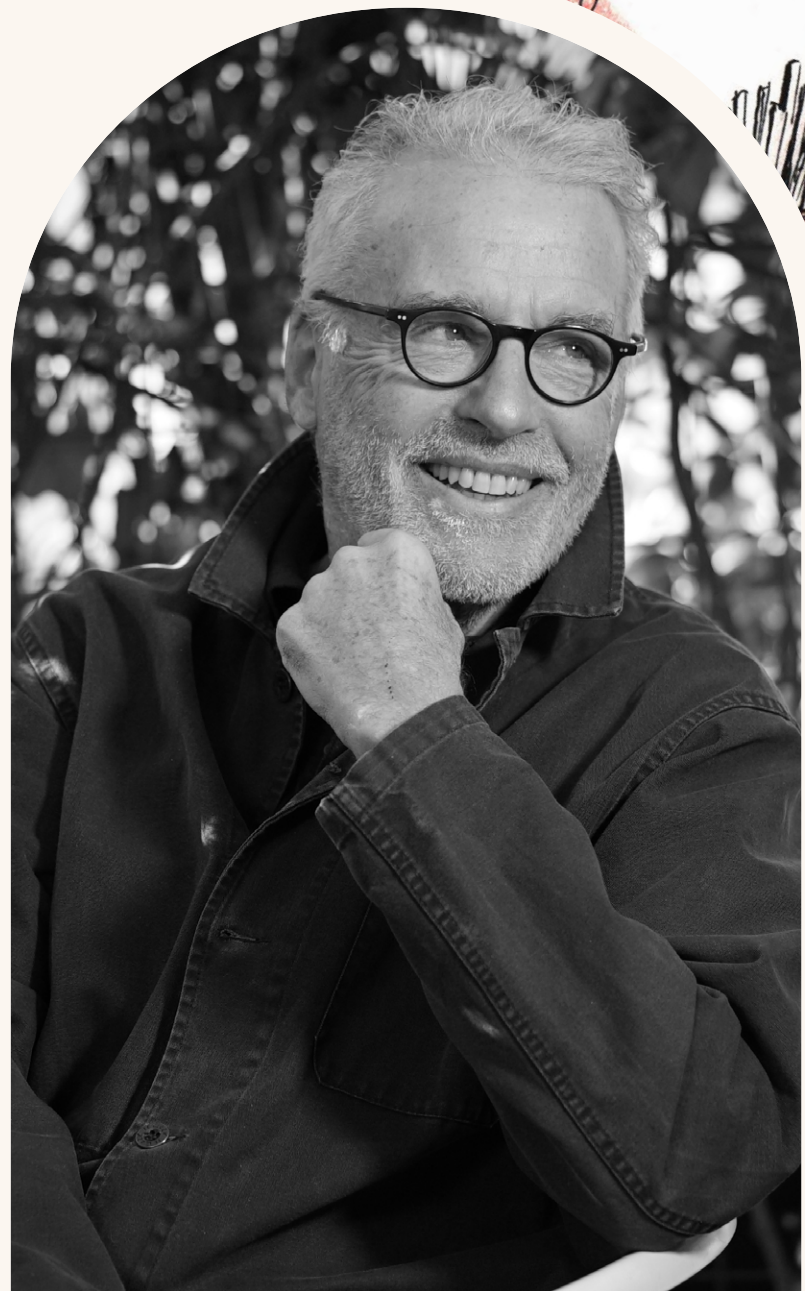

marc— sadler

LIGHT IS MAGIC AND FUNCTION UNITED

Light is a concept, a state of being, and an instrument all at the same time: magical and functional. Whether natural or artificial, it defines every space, and to design light is to guide its emotional possibilities. An example is when one can control light intensity, whether high and bright or low and intimate, they determine a sort of human quality. Even when turned off, lamps serve in a furnishing hierarchy, acting as essential elements that define the space technologically, functionally, aesthetically, and emotionally.

La luce è al tempo stesso un concetto, uno stato d'animo ed infine uno strumento: magia e funzione allo stesso tempo. Naturale o artificiale connota fortemente ogni ambiente, progettandola comporta anche gestirne la sua capacità emotiva. Per esempio poter intervenire sulla quantità di luce erogata da una lampada - forte ed intensa quando serve, debole e soffusa in situazioni più intime - ne determina la sua qualità "a misura d'uomo". Ma anche quando spente le lampade sono elementi che nella gerarchia di un'ipotetica scala di importanza surclassano altri arredi, perché dare forma alla luce permette di intervenire sullo spazio connotandolo in senso tecnologico, funzionale, estetico ed emotivo.

LaFleur

DESIGN BY MARC SADLER

technical details p. 471



A BLOOM CAPTURED IN TIME

A bloom captured in time, endless thanks to a rechargeable battery with up to 60 hours duration.

Un fiore appena dischiuso che mantiene viva la sua energia senza limiti, grazie alla batteria ricaricabile che arriva fino a 60 ore di autonomia.



SUSPENSION



WALL LAMP



CEILING LAMP



TABLE LAMP



FLOOR LAMP

EVERY PIECE IS UNIQUELY HANDCRAFTED

Lafleur is a delicate, rechargeable table lamp, made with melted Lentiflex® and molded by hand to create a soft, poetic crown. The flower's pistils help dissipate the LED warmth.

Lafleur è una delicata lampada da tavolo con batteria ricaricabile, realizzata portando a punto di fusione il Lentiflex® e modellandolo con le mani fino a creare una corolla morbida e poetica. Il pistillo del fiore ha la funzione di dissipare il calore dei LED.



PLAY VIDEO



TABLE LAMP



- Soft touch dimmer system.
- Dimmerazione tramite sistema soft touch.

WIRELESS

LED 1,3W - 5V - 150 Lumen 2700 Kelvin, Rechargeable Li-on battery.

Battery duration:
At max. intensity around 6,5 hours.
At min. intensity around 60 hours.

La durata della batteria è di 6,5 ore al massimo della potenza e intorno alle 60 ore al minimo d'intensità.



A MAGNETIC
BASE AND
COMPLIMENTARY
METAL ANCHOR
FOR SURFACES

The lamp has a magnetic base that will adhere to any metal surface. It also comes with a complimentary metal anchor for non-metal surfaces, perfect to go under the tablecloth, for example, for a mise-en-place, or for the wall to turn Lafleur into an appliqué.

La lampada ha una base magnetica per essere ancorata a tutte le superfici di metallo. Viene fornito in combo anche un disco complementare che può essere celato sotto la tovaglia di una mise-en-place o avvitato al muro per trasformare velocemente Lafleur in una applique.



TABLE LAMP

-  SUSPENSION
-  WALL LAMP
p.326
-  CEILING LAMP
-  TABLE LAMP
-  FLOOR LAMP



MARCANTONIO

THE ESSENCE OF LIGHT

Idea is the essence of light!
By removing everything structural and decorative, what remains is the distillation of light: a lightbulb with a golden base, "magically" suspended on a brass arm. The G9 light source is easily changed by simply unscrewing it from the base.

Idea è l'essenza della luce! Eliminato tutto ciò che in un corpo luminoso è un surplus di elementi decorativi, ciò che ne rimane è la vera essenza della luce: una lampadina con virola dorata "magicamente" sospesa su un' asta di ottone spazzolato. La fonte luminosa G9 è alloggiata proprio all'interno della virola svitabile per essere sostituita agevolmente.

The bulb angle can differ from lamp to lamp and is not predetermined.

L'inclinazione del bulbo sull'asta potrebbe differire tra un pezzo e l'altro e non è predeterminabile.

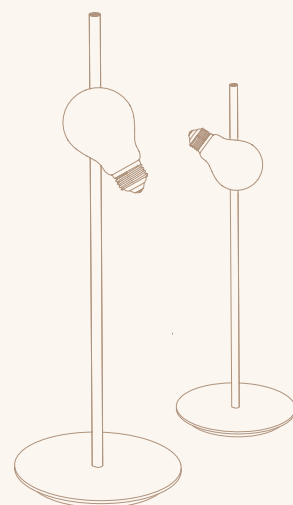

Lighting / Illuminazione:
1x5W G9 LED Bulb.

Brushed brass finiture.
Screw-base same colour
as the structure.

Struttura ottonata.
Virola in tinta con la struttura.

Atmosfera FRINGE

DESIGN BY LORENZA BOZZOLI

technical details p. 448



Atmosfera Fringe Grey

-  SUSPENSION
-  WALL LAMP
-  CEILING LAMP
-  TABLE LAMP
-  FLOOR LAMP



Atmosfera Fringe Rose

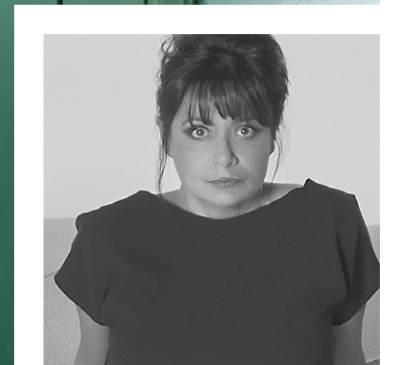

LORENZA BOZZOLI

TABLE LAMP

DUAL ILLUMINATION BASE/SHADE



Size/Dimensioni:
M: Ø30 cm x h. 44,5 cm / Ø11-3/4" x h. 17-1/4"
S: Ø20 cm x h. 29,5 cm / Ø7-3/4" x h. 11-1/2"



AT THE APEX OF FASHION AND DESIGN

Fringe dresses Atmosfera's polished base, holding a light source with an independent switch apart from the diffuser. The hand-polished sphere is richened by a brass button with Slamp's engraved logo. Stylistic details that place this lamp at the apex of fashion and design.

Le frange in tessuto "vestono" la base satinata di Atmosfera, all'interno della quale è alloggiata una fonte luminosa con accensione indipendente rispetto al diffusore. Satinata a mano, la sfera è arricchita da un piccolo dettaglio sulla parte superiore: il bottone ottonato con logo Slamp inciso. Dettagli di stile per una lampada al confine tra moda e design.

Fringe Grey

Fringe Rose

Atmosfera

DESIGN BY LORENZA BOZZOLI

technical details p. 447



TABLE LAMP

-  SUSPENSION
p.40
-  WALL LAMP
-  CEILING LAMP
-  TABLE LAMP
-  FLOOR LAMP



Size / Dimensioni M:
 Ø 30 x h. 44,5 cm
 Ø 11-3/4 x h. 17-1/4"

Size / Dimensioni S:
 Ø 20 x h. 29,5 cm
 Ø 7-3/4 x h. 11-1/2"

Atmosfera Pewter Medium and Small (background).
 In primo piano Atmosfera Pewter Medium, sullo sfondo la versione small.

ILLUMINATED POLKADOTS

Atmosfera is a 44 or 30 cm tall lamp with a hand-polished sphere and Pewterflex® or Goldflex® base. The technopolymers are perforated to reveal the sandblasted layer underneath; the light source within shines through, creating polkadots. The base and diffusor switches are independent.

Atmosfera è una lampada da 44 o 30 cm di altezza composta da una sfera satinata a mano e una base in Pewterflex® o Goldflex®. Questi materiali sono forati lasciando vedere lo strato più interno sabbato che permette alla luce celata nella base di fuoriuscire disegnando dei pois. Doppia accensione indipendente di diffusore e base.



Atmosfera Gold

Moon

25TH ANNIVERSARY
DESIGN BY SLAMP CREATIVE DEPARTMENT

technical details p. 474

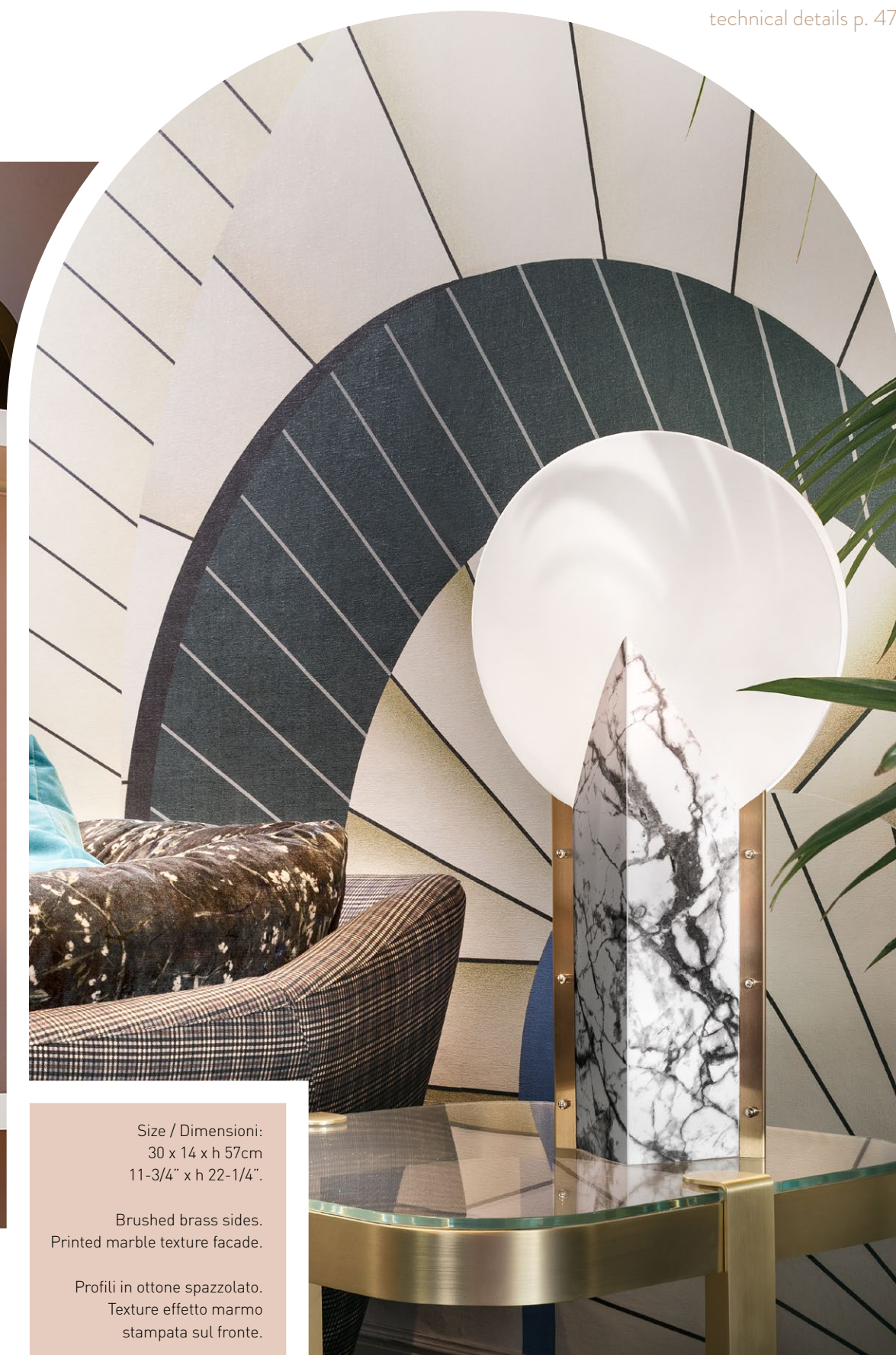

Size / Dimensioni:
30 x 14 x h 57cm
11-3/4" x h 22-1/4".

Brushed brass sides.
Printed marble texture facade.

Profili in ottone spazzolato.
Texture effetto marmo
stampata sul fronte.

TABLE LAMP

- 
 SUSPENSION
- 
 WALL LAMP
- 
 CEILING LAMP
- 
 TABLE LAMP
- 
 FLOOR LAMP

Clizia Battery

BY ADRIANO RACHELE

MAMA NON MAMA

technical details p. 457



WIRELESS

Lighting / Illuminazione:
LED 1,8W LED – 350 Lumen
2700 Kelvin.

Rechargeable battery,
duration 14h, recharging 5h.

Batteria ricaricabile,
14h di autonomia
e 5h di ricarica.

THE BOTANICAL CORDLESS TABLE LAMP

Complete with rechargeable batteries, it can be easily moved from place to place. Clizia is a perfect, original, elegant centerpiece, and even more so when choreographed in numbers along an imperial table setting.

Senza fili e con batteria ricaricabile, si sposta con la semplicità di un gesto. Perfetta da sola come centrotavola di una mise en place elegante e originale; splendida se coreografata in multipli su un lungo tavolo imperiale.

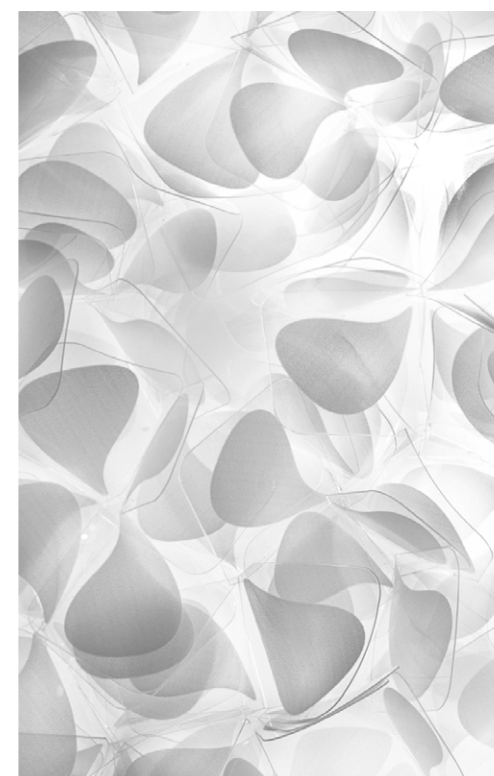

TABLE LAMP



SUSPENSION
p.70



WALL LAMP
p.346



CEILING LAMP
p.218



TABLE LAMP



FLOOR LAMP



BATTERY
POWERED

Clizia Battery FUMÉ

DESIGN BY ADRIANO RACHELE

technical details p. 457



PLAY VIDEO

BATTERY
POWERED
WIRELESS

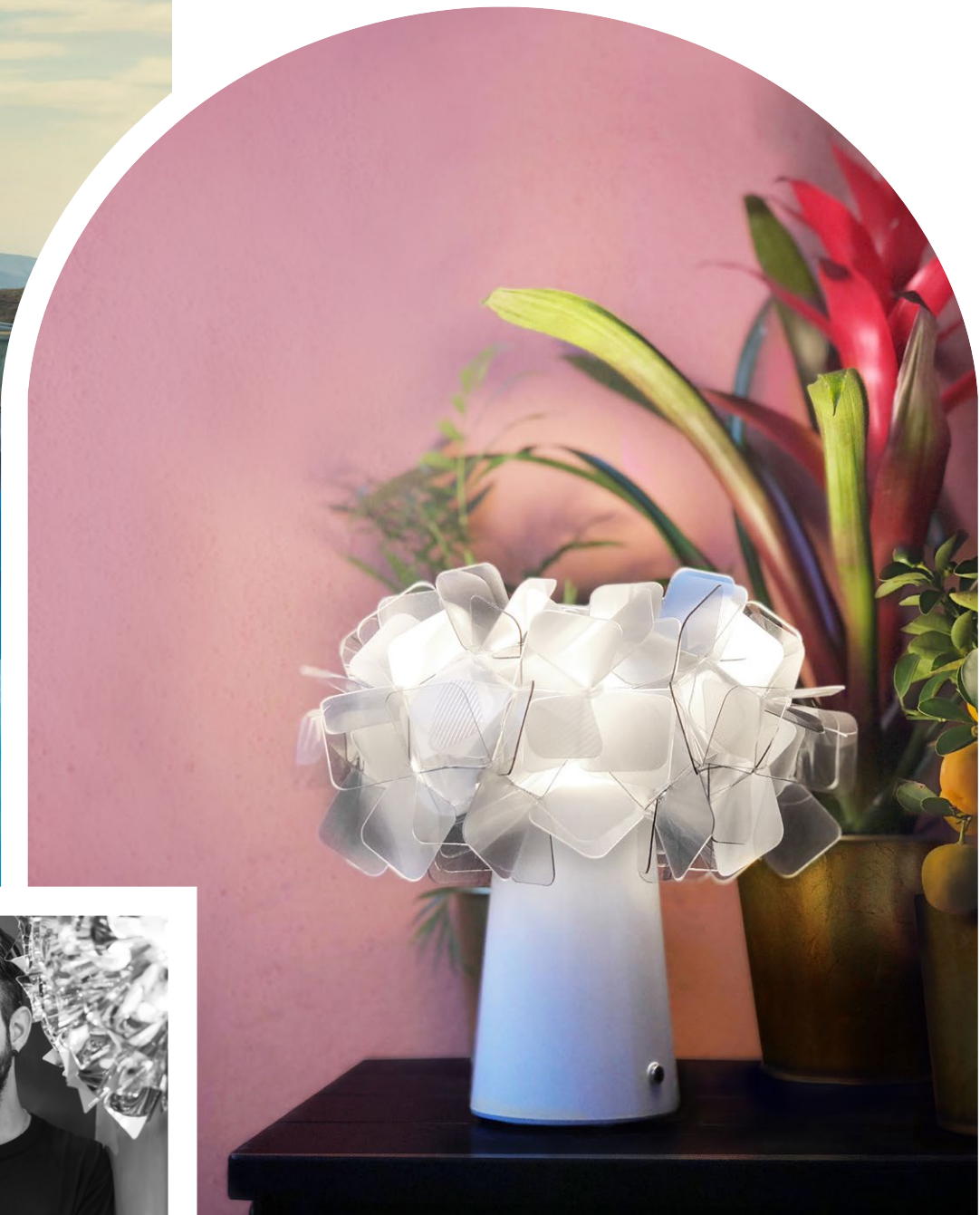

TABLE LAMP



ADRIANO RACHELE



SUSPENSION
p.76



WALL LAMP
p.350



CEILING LAMP
p.222



TABLE LAMP



FLOOR LAMP
p.416

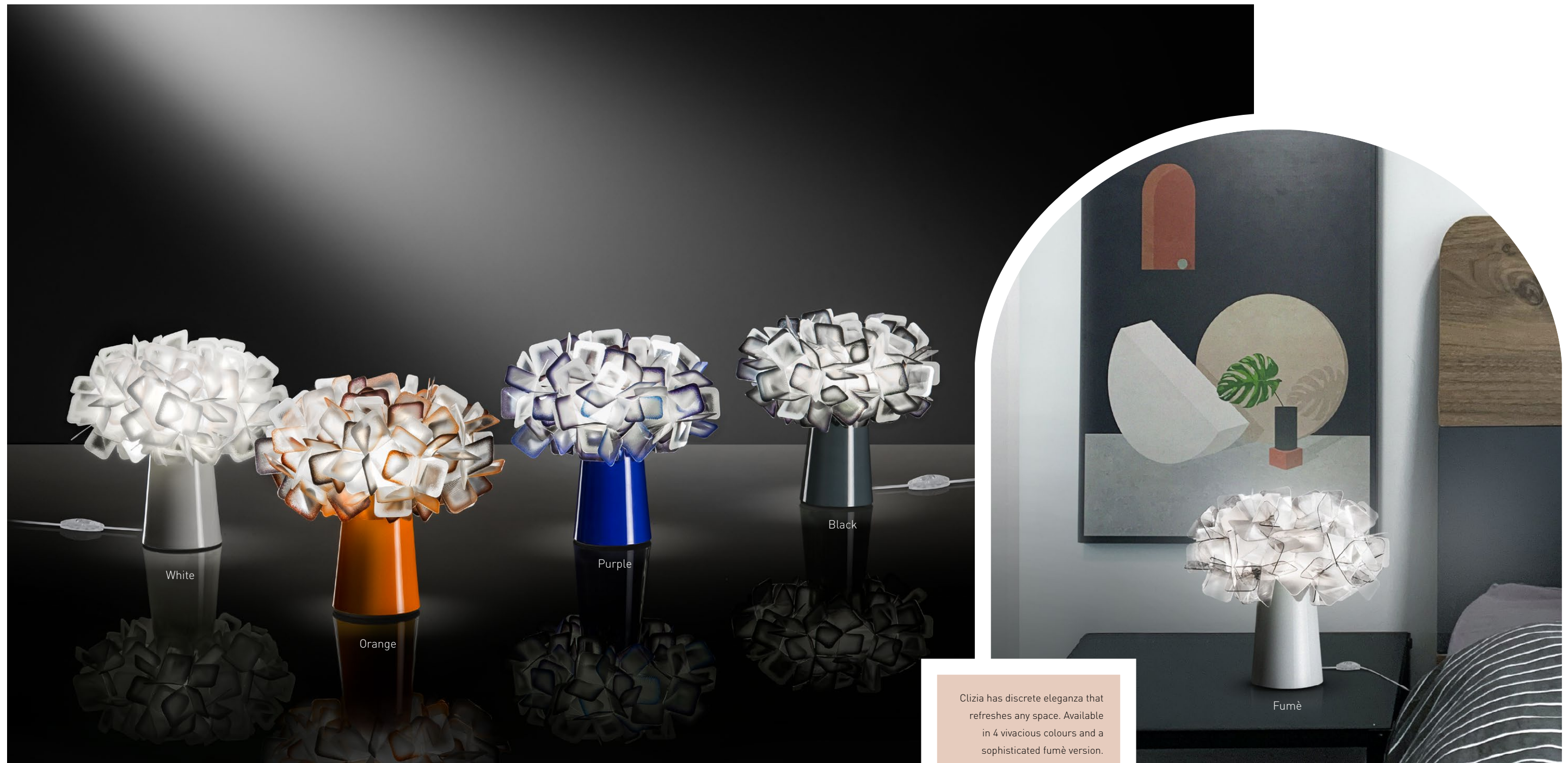

TABLE LAMP

Clizia

DESIGN BY ADRIANO RACHELE

technical details p. 457



Clizia has discrete elegance that refreshes any space. Available in 4 vivacious colours and a sophisticated fumè version.

Clizia ravviva gli ambienti con discreta eleganza. Disponibile in 4 colori briosi più la sofisticata versione Fumè.



SUSPENSION
p.78



WALL LAMP
p.350



CEILING LAMP
p.224



TABLE LAMP



FLOOR LAMP
p.416

TABLE LAMP

Liza PEWTER

DESIGN BY ELISA GIOVANNONI

technical details p. 472



TABLE LAMP

-  SUSPENSION
-  WALL LAMP
-  CEILING LAMP
-  TABLE LAMP
-  FLOOR LAMP

Size / Dimensioni:
Ø 35 cm x h. 70 cm
Ø 13" x h. 27"

Lighting / Illuminazione:
Diffusor: 1 X 12W
LED Filament Bulb + Base 1,5W
LED - 220V - 100 Lumen
2700 Kelvin.



A baroque-inspired masterpiece that unites tradition with haute design, using Slamp's technopolymers; the dual illumination includes a LED source in the main diffusor and a courtesy light in the base, and each can be used independently.

Masterpiece d'ispirazione barocca che unisce un design dal sapore tradizionale all'uso dei tecnopolimeri di Slamp. Dotata di un sistema di doppia illuminazione: LED di cortesia nella base e lampada nel cappello, con accensione indipendente.

TABLE LAMP

- 
 SUSPENSION
p.154
- 
 WALL LAMP
- 
 CEILING LAMP
- 
 TABLE LAMP
- 
 FLOOR LAMP
p.418



analogia— project

LIGHT GIVES LIFE TO THINGS

Light is able to directly intervene on a person's mood, suggesting a certain state of mind, creating inspiration and influencing desires. This is the most rewarding thing about our work; we emotionally involve people. During my London stay, we learned how to use contamination amongst diverse art forms. Thanks to that experience, I find inspiration in everyday objects, joining aesthetic value and artisan practices together through a new, original visual language. Working with light is different than working with other elements: light is something that we cannot touch, and technology is making once essential aspects, like the switch, unnecessary, leaving room for new ways in which we can interact with light...

La luce è capace di modificare l'umore delle persone, predispone a un determinato stato d'animo, aiuta a creare ispirazioni, a influenzare desideri. È proprio questo uno degli elementi più gratificanti del nostro lavoro: coinvolgere emozionalmente le persone. Durante il soggiorno londinese ho imparato a contaminare un'arte con un'altra e oggi, grazie a quell'esperienza, trovo ispirazione negli oggetti quotidiani, facendo convivere valore estetico e aspetto artigianale, con un linguaggio visivo nuovo e originale. Lavorare con la luce è molto diverso dal progettare altri accessori: la luce è impalpabile e le tecnologie di oggi rendono superflui persino alcuni elementi un tempo indispensabili, come l'interruttore, che spesso lascia il passo a nuove interazioni...

Overlay

DESIGN BY ANALOGIA PROJECT

technical details p. 476



THE PERFECT WRITING LAMP

The best gift to give passionate writers is the freedom to create without having to do anything else, without interrupting their inspirational flow: lift the pen and begin. Overlay was born of this concept. The perfect writing lamp's shade is illuminated the moment one lifts the Montblanc Meisterstück Le Grand, included with the lamp. The only thing left to do is choose the type of pen stroke.

Il più grande regalo che si può fare agli appassionati di scrittura è lasciare che, colti dall'ispirazione, non debbano pensare ad altro che a sollevare la penna e incidere per sempre sulla carta i loro pensieri. E così nasce Overlay, la perfetta lampada da scrittura, il cui diffusore si accende semplicemente sollevando la Montblanc Meisterstück Le Grand fornita in combinata con la lampada. Basta solo scegliere quale tratto di scrittura si preferisce.



PLAY VIDEO

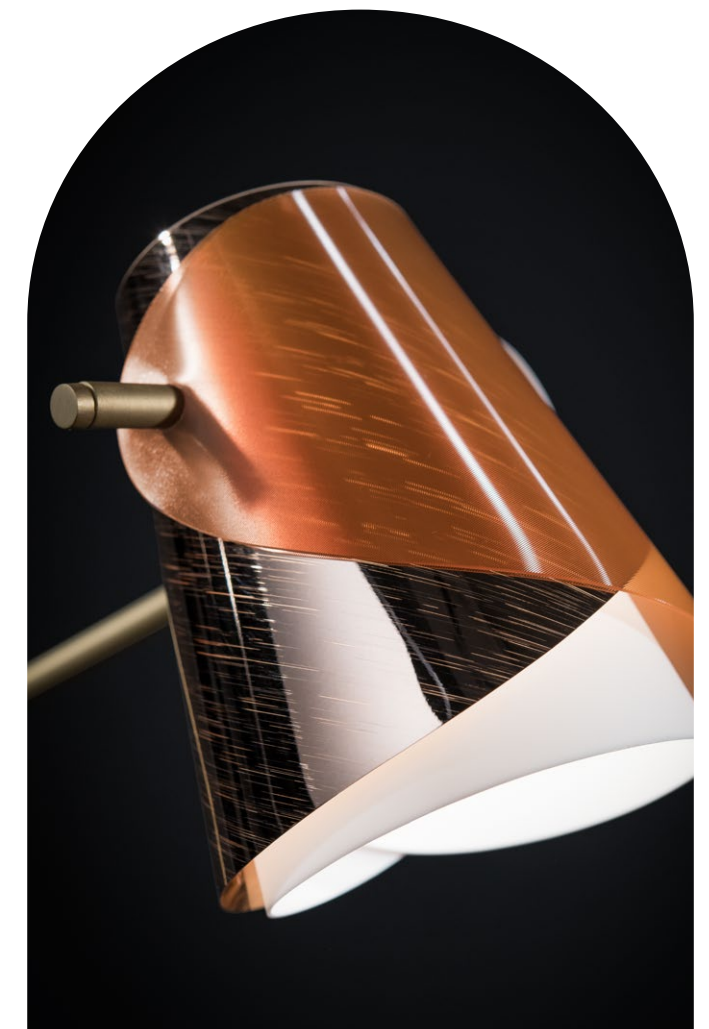

TABLE LAMP





SET OVERLAY &
Montblanc

MEISTERSTÜCK

Sold together in an elegant, personalized case.
Choose between *fountain* or *ballpoint*
writing instruments.

Vendute in combinata in un cofanetto personalizzato
Due versioni: *stilografica* e *penna a sfera*

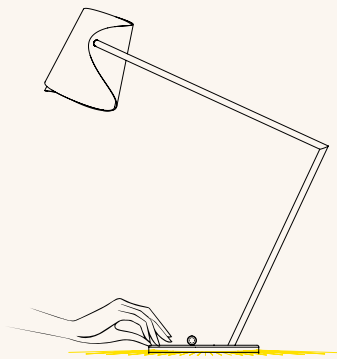

The sensitive touch system turns on the LED
courtesy light in the brass base.

Il pulsante a sfioramento accende la luce
LED di cortesia nella base in ottone.

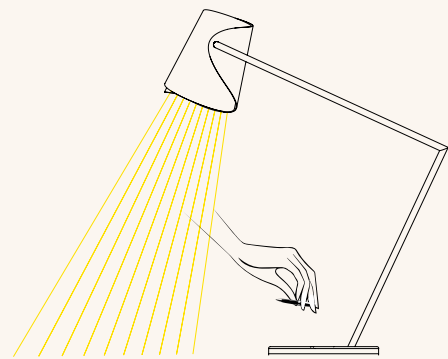

Lifting the writing instrument from the leather rest
turns on the main LED light in the Copperflex® shade.

Sollevando lo strumento da scrittura dall'alloggio in pelle,
si accende la luce LED nel diffusore in Copperflex®.



SOLD TOGETHER
WITH MONTBLANC
WRITING
INSTRUMENTS

Veli FOLIAGE

DESIGN BY ADRIANO RACHELE

technical details p. 480



TABLE LAMP

Size / Dimensione:
 Ø 28 cm x h. 28 cm
 Ø 11" x h. 11"

Veli's diffusors comes to light
 with up to 268 hand inserted
 elements: no glue, no screws.

Il diffusori di Veli contano fino a
 268 incastrati manuali,
 senza colle o viti.



SUSPENSION
p.102



WALL LAMP
p.352



CEILING LAMP
p.206



TABLE LAMP



FLOOR LAMP

Veli

DESIGN BY ADRIANO RACHELE

technical details p. 478



Veli Table Opal



SUSPENSION
p.114



WALL LAMP
p.356



CEILING LAMP
p.214



TABLE LAMP



FLOOR LAMP



Veli Table Couture

Inspired by the vast world of haute couture. Veli is a handcrafted, glamorous, and sophisticated collection.

Ispirata al variegato mondo dell'haute couture, Veli è una collezione di lampade glamour e sofisticate realizzata con un sistema di incastri eseguiti a mano.

Fiorellina

GOLD/SILVER/COPPER
DESIGN BY NIGEL COATES

technical details p. 463



Gold

Copper

Silver

Size / Dimensioni:
 Ø 33 cm x h. 34 cm
 Ø 13" x h. 13"

Available in 3 metallized
 version: Gold, Silver, Copper

Disponibile in 3 versioni
 metallizzate: Gold, Silver,
 Copper.

TABLE LAMP

- 
 SUSPENSION
 p.180
- 
 WALL LAMP
 p.382
- 
 CEILING LAMP
- 
 TABLE LAMP
- 
 FLOOR LAMP
 p.430

Fiorellina

DESIGN BY NIGEL COATES

technical details p. 463

SUGGESTIVE,
REALISTIC
AND
WELCOMING



Fiorellina Fumè

- 
SUSPENSION
p.180
- 
WALL LAMP
p.382
- 
CEILING LAMP
- 
TABLE LAMP
- 
FLOOR LAMP
p.432



Fiorellina White

Size / Dimensioni:
 Ø 33 cm x h. 34 cm
 Ø 13" x h. 13"

Expressive powers and fresh figurativism meet in a flurry of reflective, luminous petals.

La realtà dei piccoli cespugli arruffati di bosso incontra la magia del figurativismo.

Bach

DESIGN BY FRANCESCO PARETTI

technical details p. 450



Bach Gold

STATUARY, WITH ELEGANT CURVES

Slim and refined, Bach is statuary, with elegant yet rigorous curves, bringing fluid, linear movement and illumination to any interior. Available in Gold and White finishes. Table (2 sizes) and floor (3 sizes) versions available.

Snella e raffinata, Bach è uno corpo statuario e dalle tinte chiare. Le sue eleganti ma rigorose forme si legano alle moderne curvature capaci di seguire perfettamente le linee di ogni ambiente architettonico.

Disponibile in Gold e White. 2 misure da tavolo 3 da terra.



Bach Gold



Bach White



SUSPENSION



WALL LAMP



CEILING LAMP



TABLE LAMP



FLOOR LAMP
p.412

Cactus

DESIGN BY ADRIANO RACHELE

technical details p. 452



Cactus Gold



Cactus Prisma

Constructed using a hand folded system. This page: XM and XS Prisma version. Previous: Cactus Small Gold.

Sistema di incastri eseguito a mano. In questa pagina la versione Prisma XM e XS. Nella pagina precedente la versione Small Gold

TABLE LAMP



SUSPENSION
p.174



WALL LAMP



CEILING LAMP



TABLE LAMP



FLOOR LAMP
p.420

Gemmy

BY RAGNISCO, SPALLETTA, CROCE, WIJFFELS

technical details p. 464



Gemmy Arlecchino

-  SUSPENSION
p.160
-  WALL LAMP
-  CEILING LAMP
-  TABLE LAMP
-  FLOOR LAMP



Gemmy Multicolor

Size / Dimensione:
Ø22 cm x h. 33 cm
Ø 8-3/4" x h. 13"
White steel base.
Available in 6 colours.
Base in acciaio
verniciato bianco.
.Disponibile in 6 colori.

Gemmy

BY RAGNISCO, SPALLETTA, CROCE, WIJFFELS

technical details p. 464

INSPIRED BY THE POLYHEDRIC FACETS OF DESERT GEMS

The lamp's geometries create an intriguing contemporary and refined kaleidoscope effect that enriches any interior.

Con le sue poliedriche sfaccettature, avvolge geometricamente la luce e genera intriganti effetti caleidoscopici, capaci di arricchire con carattere ogni interior.



VERSATILE
AND
DYNAMIC

The Gemmy collection includes a vast range of colours that adapt seamlessly to any modern space.

La varietà di gamma rende Gemmy una lampada versatile in grado di adeguarsi agli interni più contemporanei.

-  SUSPENSION p.162
-  WALL LAMP
-  CEILING LAMP
-  TABLE LAMP
-  FLOOR LAMP p.426

TABLE LAMP

Diamond

DESIGN BY PAOLUCCI, STATERA

technical details p. 459



INSPIRED BY THE ICONIC WORKS OF BRANCUSI

Sculptural, dynamic, and modern, Diamond's geometric design allows the light to accentuate its various facets and angles.

Scultorea, dinamica e contemporanea, Diamond ha un design geometrico che, incontrando la luce, si delinea fino ad accentuarne le forme sfaccettate.

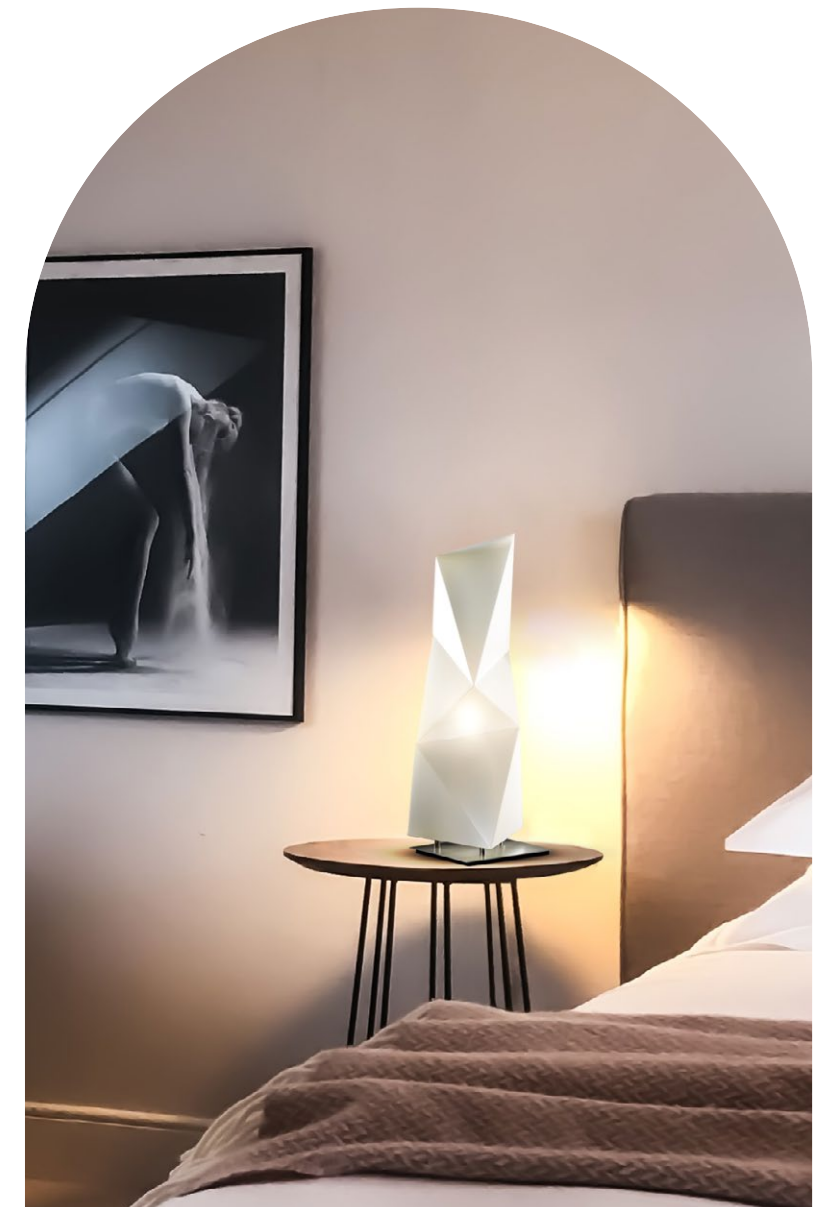

TABLE LAMP



Venti

DESIGN BY ALESSANDRO MENDINI

technical details p. 480



AN ALESSANDRO
MENDINI MASTERPIECE
FROM THE 90'S



Size / Dimensioni:
21 cm x 10 cm h. 39 cm
Ø 8 - 1/4" x 3 - 3/4" x h. 5 - 1/4"
Light / Luce:
1 X 6W LED Filament Bulb
E14/E12



SUSPENSION



WALL LAMP
p.374



CEILING LAMP
p.244



TABLE LAMP



FLOOR LAMP
p.436

Mille Bolle

DESIGN BY ADRIANO RACHELE

technical details p. 474



SOAP BUBBLES OF FLEETING EMOTIONS

Tiny sheets of iridescent polycarbonate are expertly folded into a charming diffusor that casts a kaleidoscope of luminous "soap bubbles".

Il fascino del diffusore, realizzato a mano piegando ad arte piccoli fogli di policarbonato iridescente, si accende in un caleidoscopico effetto luminoso per ricreare l'emozione fugace delle bolle di sapone.

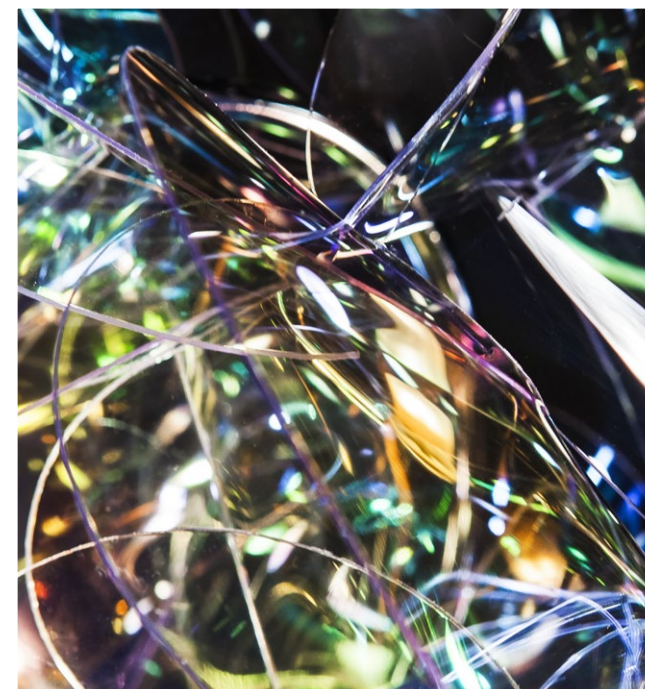

SUSPENSION
p.168



WALL LAMP
p.370



CEILING LAMP



TABLE LAMP



FLOOR LAMP
p.438

Las Palmas

DESIGN BY JONAS CLEMENTONI

technical details p. 471

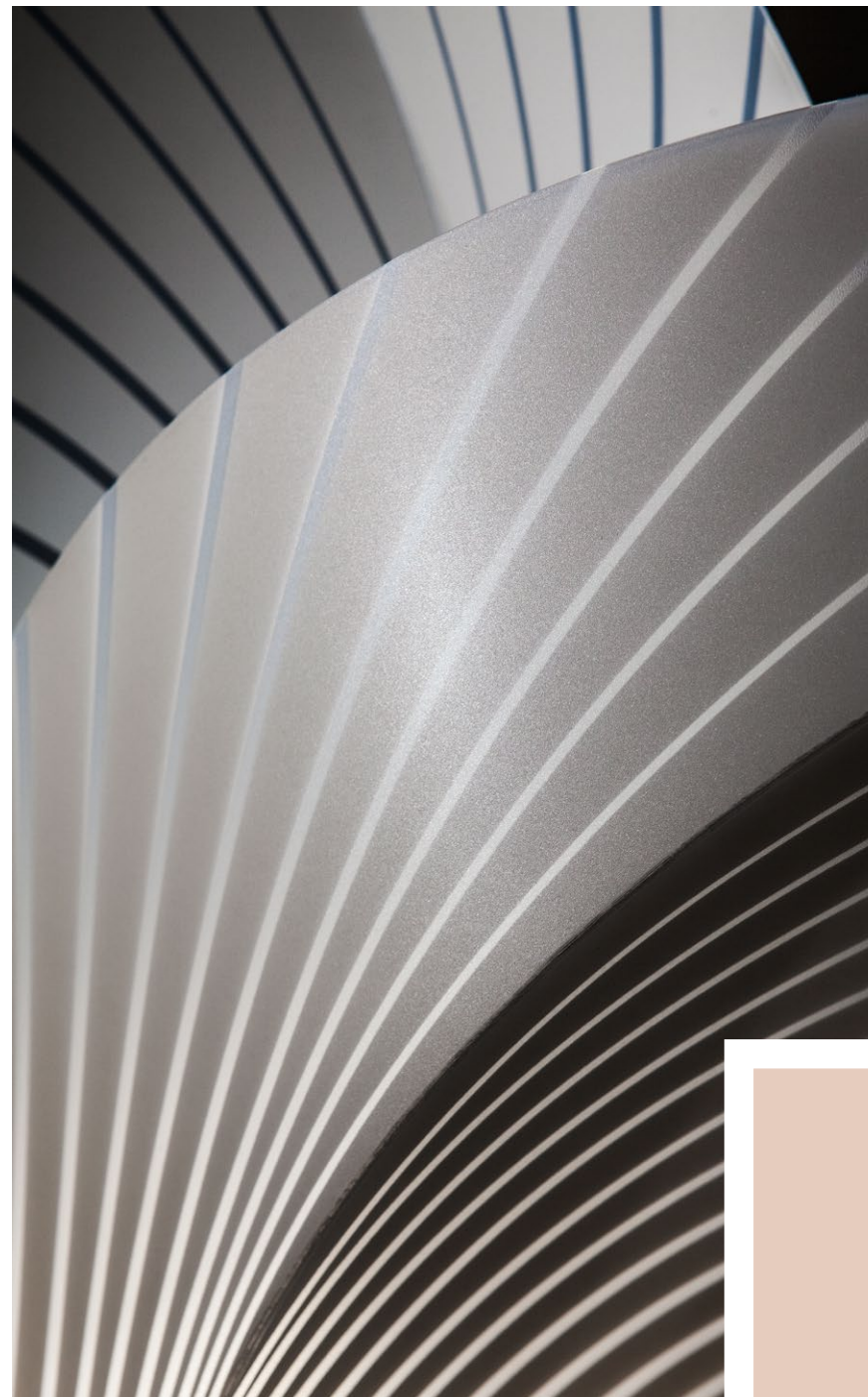

Size / Dimensione:
18 x 21 x h. 57,5 cm
8-1/2" x 7" x h. 22"

Polished steel
sides and base.

Base e profili
in acciaio lucido.





WHITE TONAL DECORATION

The name conjures up the image of a mythical nymph turned tree, and the illumination is balanced and peaceful. The charming tone on tone decoration has been inspired by laurel leaves.

Il nome della lampada porta con sé l'immaginario mitico della trasformazione della Ninfa da donna in arbusto. Con la sua luce, genera una sensazione di pace ed equilibrio: il segreto del suo fascino sta nel delicato decoro tono su tono, ispirato alla pianta di alloro.



TABLE LAMP

- 
 SUSPENSION
p.160
- 
 WALL LAMP
p.376
- 
 CEILING LAMP
p.240
- 
 TABLE LAMP
- 
 FLOOR LAMP
p.432

Bios

DESIGN BY NIGEL COATES

technical details p. 451



Two sheets of Opalflex® are layered, creating abstract patterns that create suggestive plays of light.

Attraverso i fori irregolari, dalla sovrapposizione di due strati di Opalflex®, filtra una luce che crea suggestivi giochi di luci e ombre.

TABLE LAMP



SUSPENSION



WALL LAMP
p.372



CEILING LAMP
p.238



TABLE LAMP



FLOOR LAMP
p.434



Mida Medium Multicolor



Size / Dimensioni:
 M: Ø 50 cm x h. 16 cm
 Ø 19" x h. 6-1/4"
 L: Ø 67 cm x h. 21 cm
 Ø 26" x h. 8-1/4".
 Integrated magnetic system.
 Dotata di attacco magnetico.

Mida Medium Rose



Mida Medium Amber



Amber detail /dettaglio



Mida Large White/Platinum

HAUTE COUTURE JEWELS

Mida is a ceiling/wall lamp with our exclusive magnetic system for easy installation and maintenance, inspired by polished cabochon geometrically placed across a floral corolla with silky, iridescent stones.

Dotata di attacco magnetico per una facile installazione e semplice manutenzione, Mida si ispira ai cabochon lisci e levigati che si dispongono in maniera ordinata a disegnare la corolla di un fiore dai colori cangianti e setosi.

Mida APPLIQUE

DESIGN BY ADRIANO RACHELE

technical details p. 473



Mida Applique - Multicolor



Mida Applique - White/Gold

Size / Dimensioni:
 Ø 32 cm x h. 12 cm
 Ø 12 -1/2" x h. 4-1/2"

4 coloured gems and
 5 metallic gems,

4 gemme colorate
 e 5 metallizzate.

WALL LAMP





marcantonio

A LIGHTBULB IS A LIVING ESSENCE

"We wanted to create a surprising, magical effect, like when a lightbulb goes off in your head along with a great idea. Creating a lamp is like creating something that is alive."

The Idea collection strips away design, leaving the essence of light; magically suspended, the unexpected irony is pure genius. Eureka!

"Volevamo creare un effetto magico, un effetto sorprendente: come la lampadina che si accende in testa quando hai un'idea. Per me creare una lampada significa creare qualcosa che poi vive."

E la collezione Idea lo racconta attraverso una serie di prodotti che, eliminato ogni vezzo decorativo, celebrano l'essenza stessa della luce. Magicamente sospesa, amplifica l'effetto ironico e inaspettato dell'idea che si presenta quando meno te l'aspetti. Eureka!

Idea

RECESSED WALL
DESIGN BY MARCANTONIO

technical details p. 468

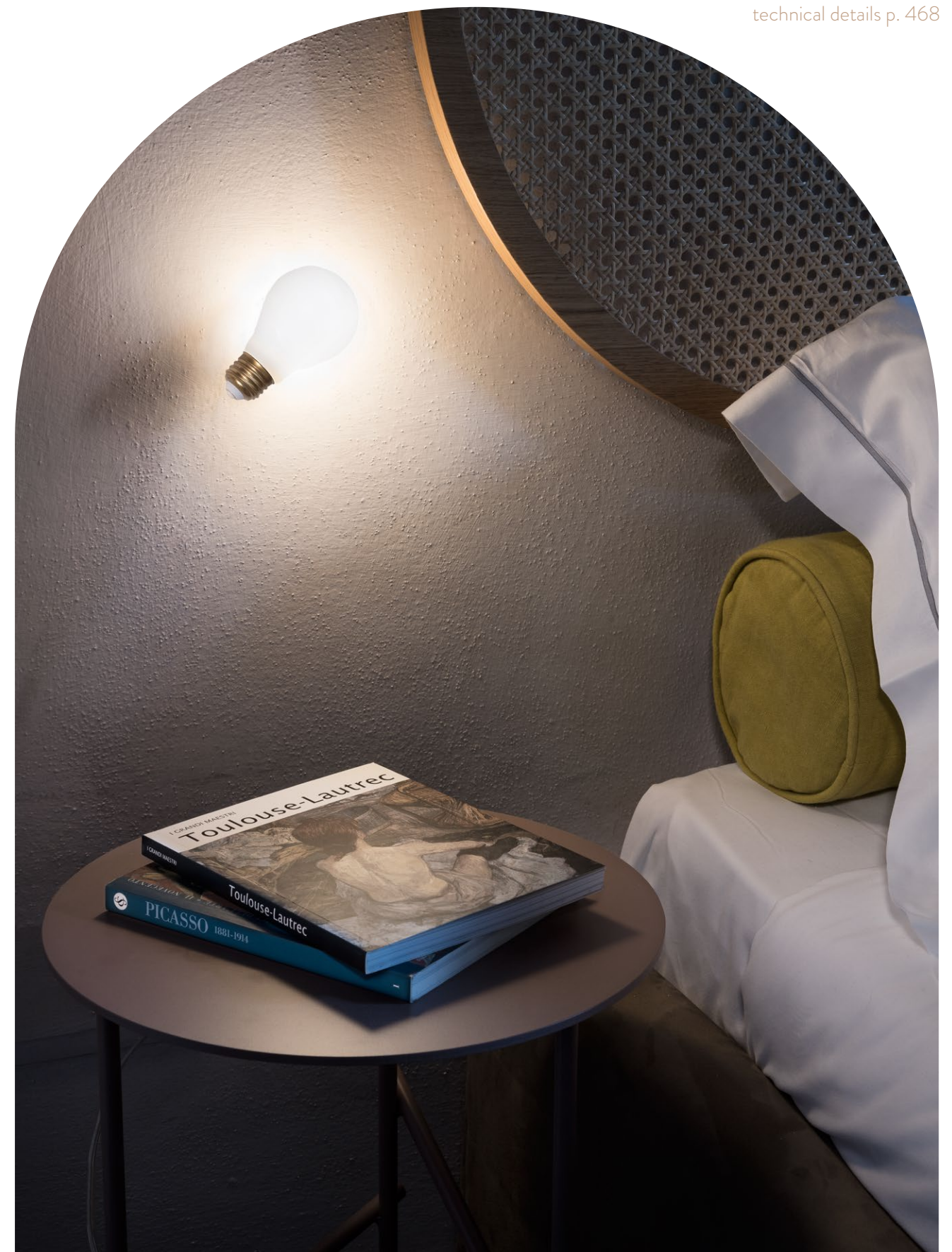

-  SUSPENSION
-  WALL LAMP
-  CEILING LAMP
-  TABLE LAMP
p.258
-  FLOOR LAMP



The recessed version can be placed within drywall for a floating effect. Dimmable G9 LED bulbs make for easy substitution.

La versione Recessed può essere incassata per un effetto a scomparsa. Lampadina G9 a LED dimmerabile e facilmente sostituibile.

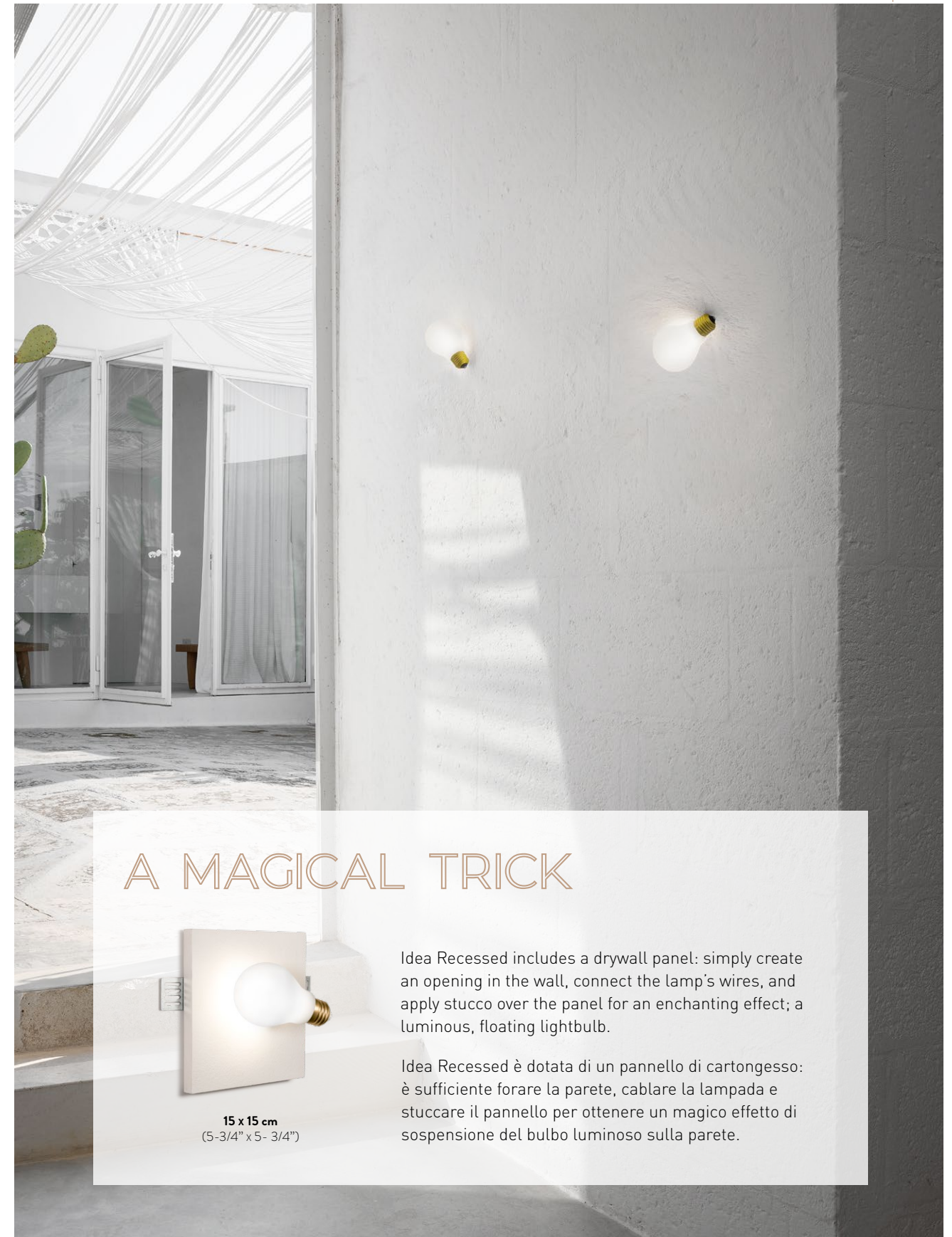

A MAGICAL TRICK



15 x 15 cm
(5-3/4" x 5-3/4")

Idea Recessed includes a drywall panel: simply create an opening in the wall, connect the lamp's wires, and apply stucco over the panel for an enchanting effect; a luminous, floating lightbulb.

Idea Recessed è dotata di un pannello di cartongesso: è sufficiente forare la parete, cablare la lampada e stuccare il pannello per ottenere un magico effetto di sospensione del bulbo luminoso sulla parete.



Mirrored Stainless Steel
Acciaio effetto specchio

INSPIRATION COMES LIKE A LIGHTBULB GOING OFF IN YOUR HEAD

They say inspiration comes like a lightbulb going off in your head. They also say good things come in small packages. Reinventing this universal archetype required genius folly and sartorial expertise.

Dicono che l'ispirazione si accenda all'improvviso come una lampadina sulla testa. Dicono anche che le cose migliori arrivano in pacchetti piccoli. Reinventare questi archetipi richiede una certa dose di geniale follia e di esperienza manifatturiera.

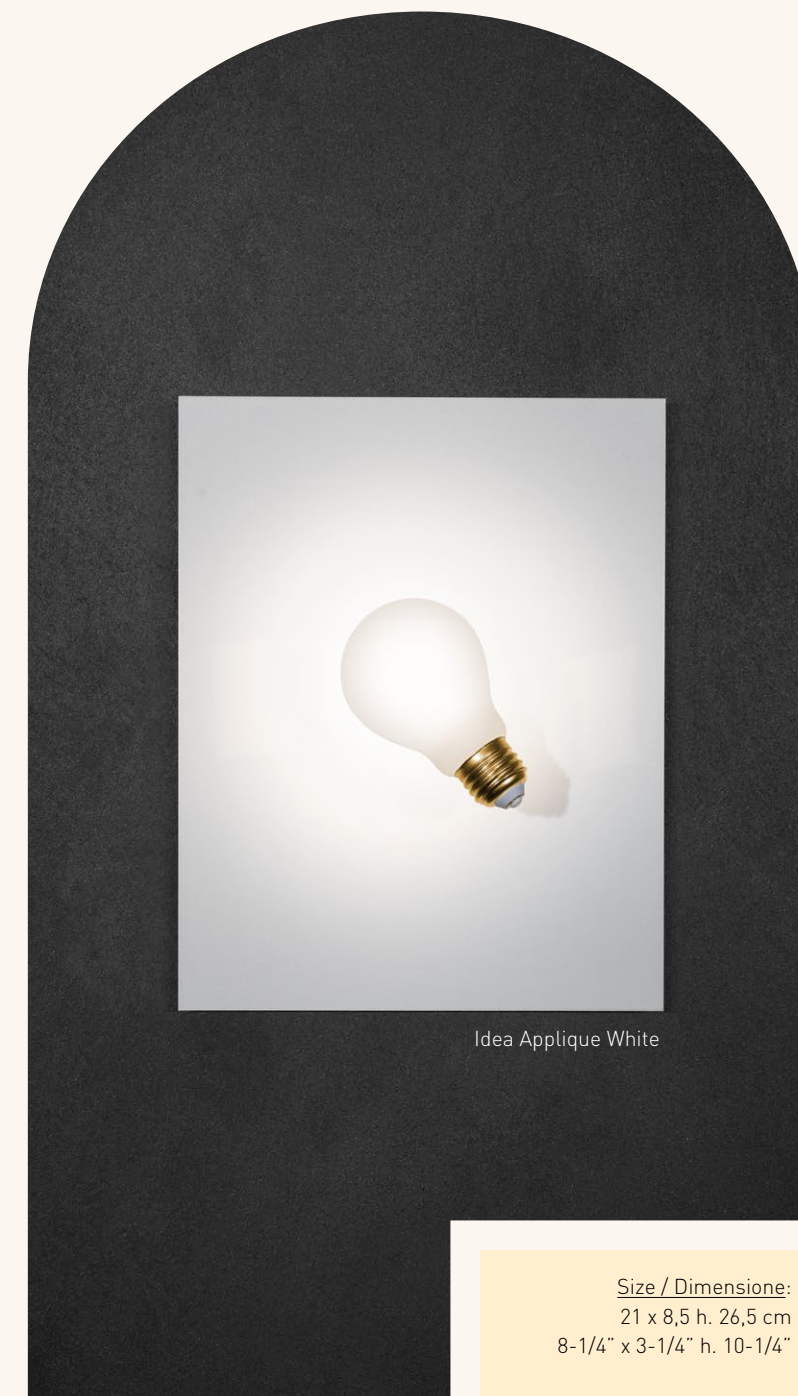
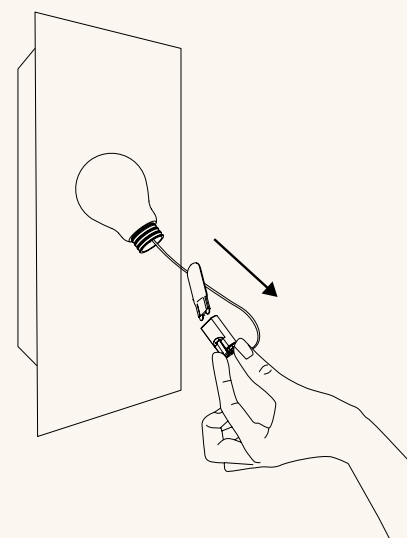

Idea Applique White

Size / Dimensione:
21 x 8,5 h. 26,5 cm
8-1/4" x 3-1/4" h. 10-1/4"

Available in stainless steel or white steel.

Disponibile in acciaio effetto specchio o acciaio verniciato bianco.



SUSPENSION



WALL LAMP



CEILING LAMP



TABLE LAMP
p.258



FLOOR LAMP

Charlotte

BY DORIANA AND MASSIMILIANO FUKSAS

technical details p. 455



Size / Dimensione:

21 x 12,5 x h.32 cm
8-1/4" x 5" x h. 12 1/2".

Lighting / Illuminazione:

1 X 12W LED Filament
bulb E27/E26.



TURNING A TWO-DIMENSIONAL ELEMENT INTO INFINITELY MULTIPLYING SHAPES

Charlotte Applique is created from a world of illusion, from the challenge of turning a two-dimensional element into infinitely multiplying shapes. The reflective surfaces within the lamp amplify the light source, emphasising the hypnotic concentric patterns.

Charlotte nasce dalla sfida di trasformare un elemento bidimensionale in volumi che si moltiplicano all'infinito. La superficie riflettente nascosta all'interno della lampada amplifica il potere della fonte luminosa enfatizzando la trama ipnotica degli esagoni concentrici.



SUSPENSION
p.60



WALL LAMP



CEILING LAMP



TABLE LAMP



FLOOR LAMP
p.392

La Lollo

DESIGN BY LORENZA BOZZOLI

technical details p. 470



La Lollo Gold



WALL LAMP

La Lollo Pewter/White

Size / Dimensione:
28 x 16 x h.30 cm
11" x 6-1/4" x h. 11 3/4".

Lighting Illuminazione:
2 X 6W LED Filament
Bulb E14/E12.



SUSPENSION
p.84



WALL LAMP



CEILING LAMP



TABLE LAMP



FLOOR LAMP
p.402

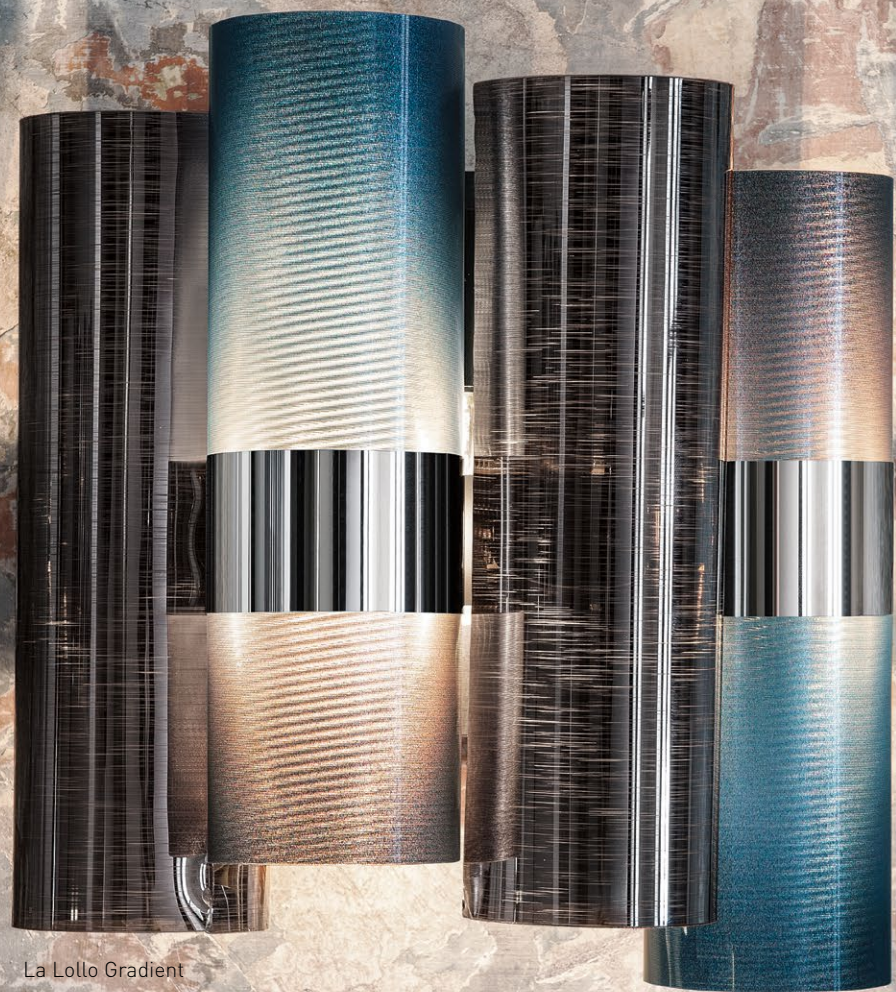

La Lollo Gradient

La Lollo adorns varying spaces with the same versatility as jewelry on a woman's body. Slamp's unique, exclusive technopolymers shine like glass, but are unbreakable, perfect in multiples to illuminate a long hallway.

La Lollo decora l'ambiente con la stessa versatilità con cui un gioiello adorna il corpo di una donna. Realizzata con i tecnopolimeri di Slamp, che offrono brillantezza e infrangibilità, La Lollo è perfetta in multipli sulla parete di un lungo corridoio



New La Lollo White, with Lentiflex® and Opalflex® *couture* cylinders.

La Lollo applique nella nuova finitura white, realizzata con cilindri in Lentiflex® e Opalflex® effetto *couture*.

La Vie

DESIGN BY ADRIANO RACHELE

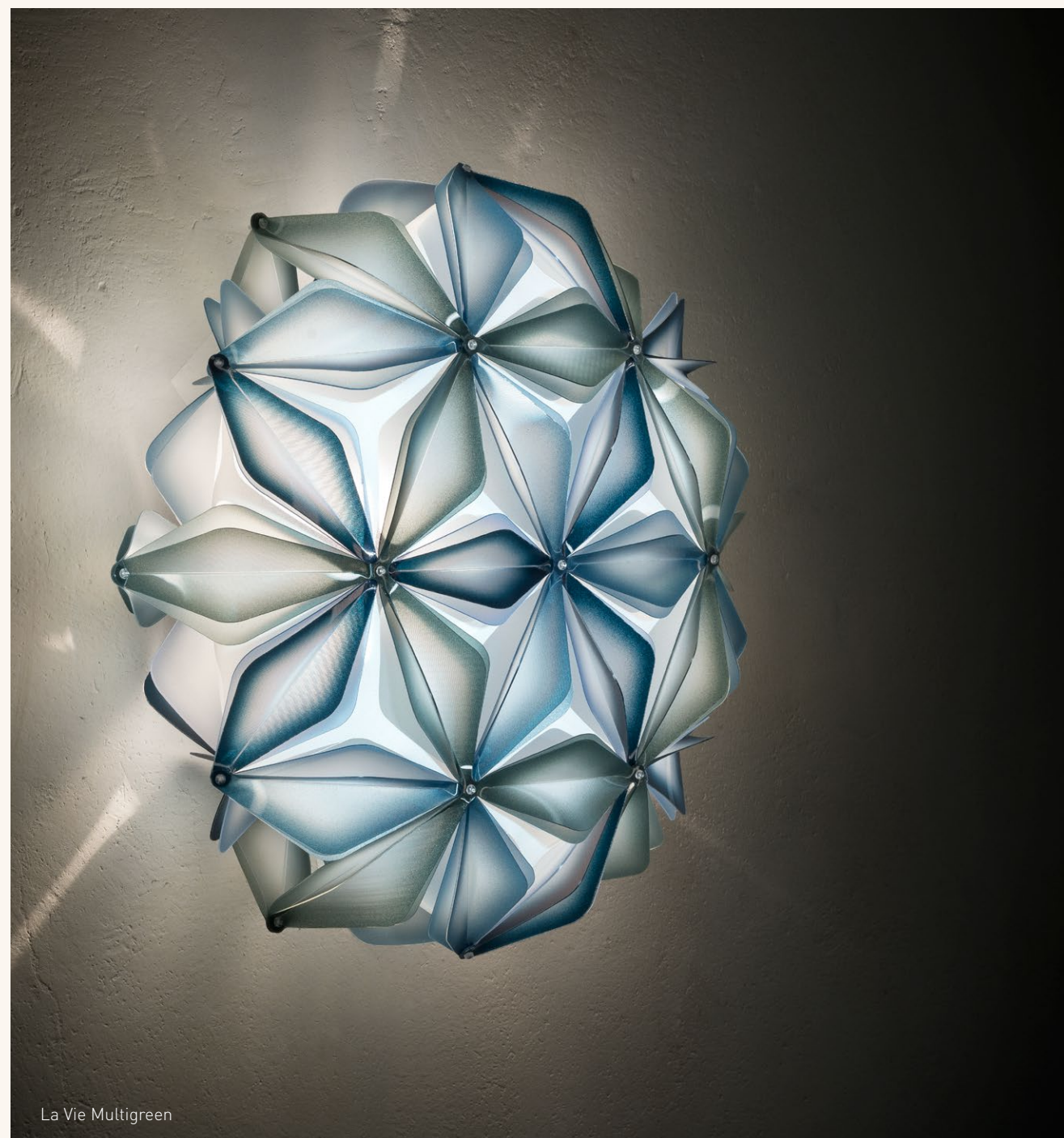

La Vie Multigreen



SUSPENSION



WALL LAMP



CEILING LAMP
p.188



TABLE LAMP



FLOOR LAMP



THE
ESSENCE
OF
EVERYTHING
IN A
SINGLE
PATTERN

Foreground: La Vie Amber, in the background the Blue version.
In primo piano La Vie Amber, sullo sfondo la versione Blu.



La Vie Multiblue

The immediacy of a symbolic language is found throughout the universe, from a single atom to galaxies, the essence of life in micro and macrocosms. La Vie is a symbol of balance, rebirth, and protection, bringing untiring harmonious energy to every day.

In un efficace linguaggio simbolico in cui si ritrovano tutte le forme dell'universo - dagli atomi alle galassie - si racchiude l'essenza della vita, la relazione tra micro e macrocosmo. Simbolo di equilibrio, rinascita e protezione, La Vie porta nella quotidianità un'inesauribile fonte di energia e di armonia.



La Vie White



La Vie White

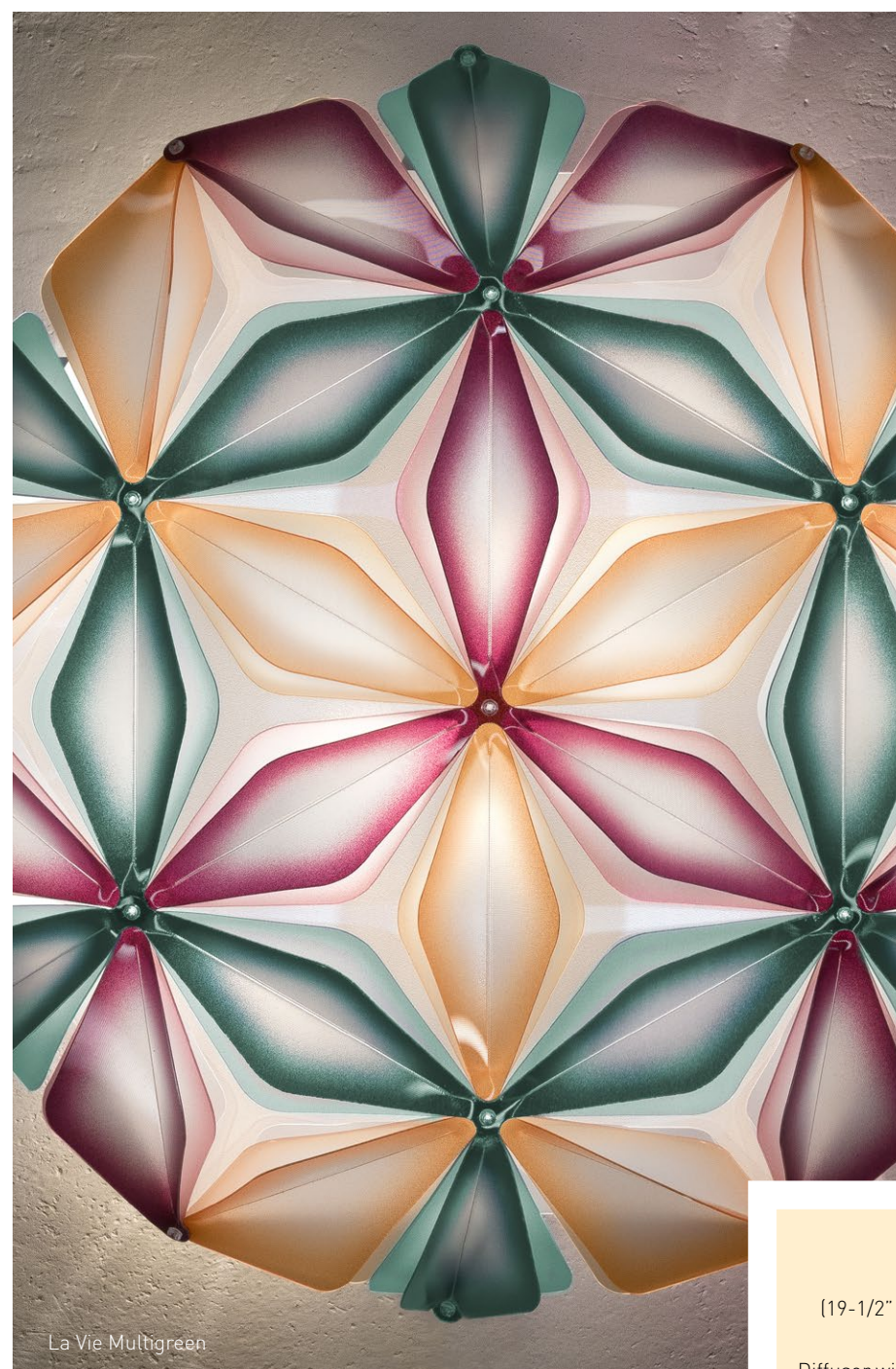

La Vie Multigreen



La Vie Amber

Size / Dimensioni:
50 x 47 x h.19 cm
(19-1/2" x 18-1/4" x h.7-1/2")
Diffusor with Magnetic System.
Diffusore dotato di
attacco magnetico.

WALL LAMP

Hanami

DESIGN BY ADRIANO RACHELE

technical details p. 465



A SYMBOL OF DELICATE POETRY

Hanami's unique, delicately coloured illumination is distributed throughout hand-folded flowers made of Lentiflex®, a noble material that recreates diamond-like reflections

Hanami offre con versatilità un'illuminazione unica dai colori delicati, distribuendo i suoi fiori plissettati a mano in Lentiflex®, materiale nobile che permette di ricreare i riflessi di un diamante.



SUSPENSION
p.124



WALL LAMP



CEILING LAMP
p.226



TABLE LAMP



FLOOR LAMP



LOVES ME, LOVES ME NOT?

This bouquet's light, delicate petals bring a soft breeze of balanced allure into any interior. Integrated magnetic system facilitates cleaning and maintenance.

I petali leggeri e delicati di questo bouquet luminoso portano negli interni una ventata di aria fresca e un allure equilibrato. Dotata di attacco magnetico per veloce pulizia e manutenzione.

Available in 4 sizes and 2 other designs. Left: Clizia Ceiling/wall Medium; right: Clizia Applique.

Disponibile in 4 misure e 2 design alternativi. A sinistra: Clizia Ceiling/wall Medium; A destra: Clizia Applique.

White decor on transparent material



WALL LAMP



Clizia PIXEL

DESIGN BY ADRIANO RACHELE

technical details p. 456



White decor on transparent material

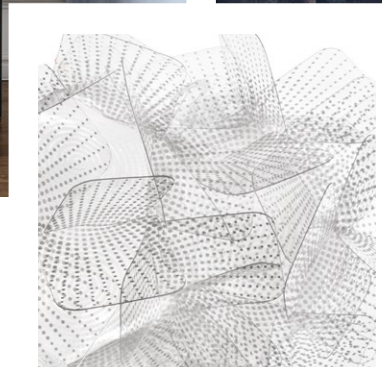

White decor on transparent material



Integrated magnetic system facilitates cleaning and maintenance. Available in 4 sizes and 2 other designs.

Dotata di attacco magnetico per veloce pulizia e manutenzione. Disponibile in 4 misure e 2 design alternativi.

- 
SUSPENSION
p.74
- 
WALL LAMP
- 
CEILING LAMP
p.220
- 
TABLE LAMP
- 
FLOOR LAMP

Clizia

DESIGN BY ADRIANO RACHELE

technical details p. 456



Clizia Large White



ADRIANO RACHELE

Clizia Large Fumè



SUSPENSION
p.78



WALL LAMP



CEILING LAMP
p.224



TABLE LAMP
p.278



FLOOR LAMP
p.416



Veli Large Foliage



Veli Large Foliage

WALL LAMP

Handcrafted folds and bends create union of soft, sartorial features and the perfection of the natural world.

Realizzata con incastri realizzati a mano, è un connubio tra la morbidezza del mondo sartoriale e la perfezione del mondo naturale.

- 
 SUSPENSION
p.102
- 
 WALL LAMP
- 
 CEILING LAMP
p.206
- 
 TABLE LAMP
p.290
- 
 FLOOR LAMP

Veli COUTURE

DESIGN BY ADRIANO RACHELE

technical details p. 478



Veli Medium Couture

SUSPENSION
p.106

WALL LAMP

CEILING LAMP
p.208

TABLE LAMP
p.292

FLOOR LAMP



Personalised with a soft finish that was inspired by modern fabric textures. The diffuser has a magnetic system that facilitates cleaning.

Personalizzata con una delicata finitura ispirata alle texture tessili contemporanee. Dotata di attacco magnetico per staccare il diffusore e pulirlo facilmente.

Veli Large Couture

WALL LAMP

Veli

DESIGN BY ADRIANO RACHELE

technical details p. 478

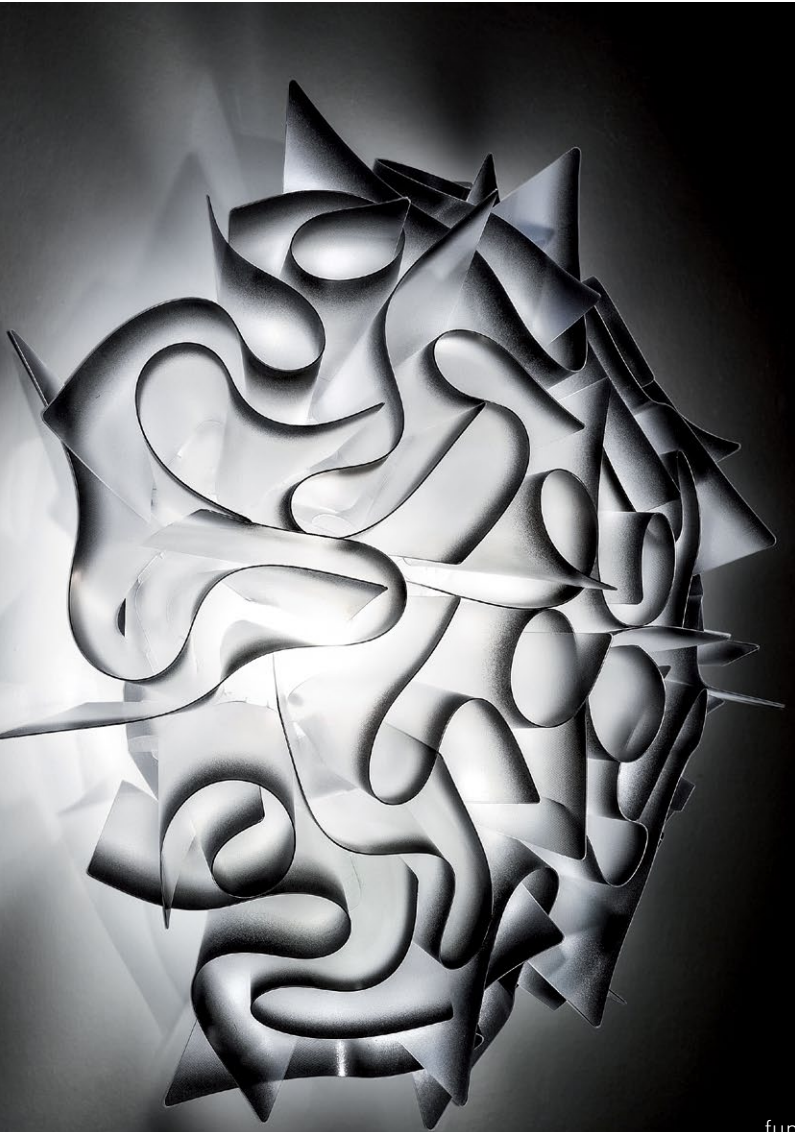

**AESTHETICS
MEET LUSH,
DECORATIVE
DETAILS**

Slamp's iconic, internationally celebrated design is ideal for aesthetic charm and functionality in one; the diffuser has a magnetic system that facilitates cleaning.

Design iconico di Slamp, premiato con un riconoscimento internazionale, ideale per chi cerca estetica e funzionalità in un solo prodotto grazie all'attacco magnetico per staccare il diffusore e pulirlo agevolmente.

Veli Medium Charcoal

-  SUSPENSION p.114
-  WALL LAMP
-  CEILING LAMP p.214
-  TABLE LAMP p.292
-  FLOOR LAMP



WALL LAMP

Veli PRISMA

DESIGN BY ADRIANO RACHELE

technical details p. 478



- 
 SUSPENSION
p.112
- 
 WALL LAMP
- 
 CEILING LAMP
p.210
- 
 TABLE LAMP
- 
 FLOOR LAMP



WALL LAMP



Veli Large Gold, Veli Medium Silver, Veli Mini Copper

HIGHLY PIGMENTED
METALLICS,
UNIQUE TREATMENTS



Veli Silver detail

Slamp's unique, flexible technopolymers undergo metallisation through an exclusive process of aluminium vapourisation that guarantees resistance and shine.

I tecnopolimeri flessibili e unici di Slamp subiscono un esclusivo processo di metallizzazione a vapori di alluminio che garantisce brillantezza e resistenza.

- 
 SUSPENSION
p.110
- 
 WALL LAMP
- 
 CEILING LAMP
p.212
- 
 TABLE LAMP
- 
 FLOOR LAMP

La Belle Étoile

DESIGN BY ADRIANO RACHELE

technical details p. 469



Both a ceiling and wall lamp, with an easily-replaced LED source and magnetic system that facilitates maintenance.

Utilizzabile come plafoniera o lampada da parete, monta un sistema a LED brevettato facilmente sostituibile tramite sistema magnetico.



SUSPENSION
p.94



WALL LAMP



CEILING LAMP
p.228



TABLE LAMP



FLOOR LAMP

Étoile

DESIGN BY ADRIANO RACHELE

technical details p. 461



A
MAGNETIC
LED SOURCE
CAN BE
EASILY
REMOVED



Size / Dimensioni:
Ø 73 cm x h. 23 cm
Ø 21" x 8-3/4"

Integrated Magnetic System
and changeable LED source.

Dotata di Attacco Magnetico
e sistema LED sostituibile.

WALL LAMP



SUSPENSION
p.98



WALL LAMP



CEILING LAMP
p.230



TABLE LAMP



FLOOR LAMP

Drusa

DESIGN BY ADRIANO RACHELE

technical details p. 460



LIKE
CRYSTALS
POKING OUT
FROM
THE ROCKS

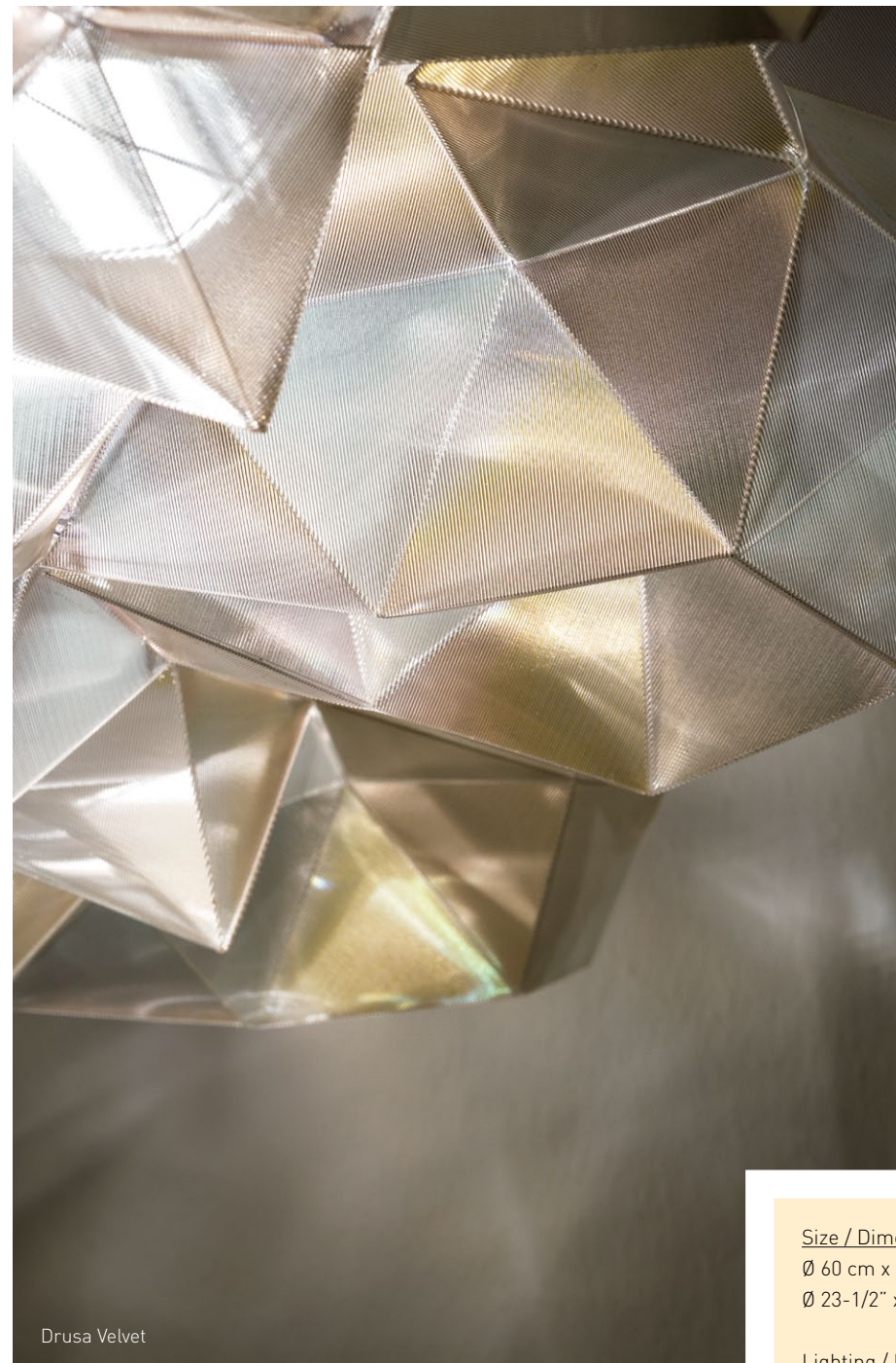

Drusa Velvet



Drusa White

Size / Dimensioni:
Ø 60 cm x h. 20 cm
Ø 23-1/2" x h. 8"

Lighting / Luce:
4 X 12W E27/E26
LED Filament Bulbs



SUSPENSION
p.152



WALL LAMP



CEILING LAMP
p.232



TABLE LAMP



FLOOR LAMP

Mirage

DESIGN BY MANUEL WIJFFELS

technical details p. 474



AN OPTICAL ILLUSION

Light turns into pure adornment; the central LED source explodes from inside the structure, creating fireworks only when the lamp is turned on.

La luce diventa decoro tramite la corolla di LED che brilla come un fuoco d'artificio al centro della struttura rivelandosi solo all'accensione



Lighting / Illuminazione:
LED 14W - 220Vac/12Vdc
1100 Lumen - 2700 Kelvin

Size / Dimensioni:
10 x 27 x h. 55 cm
4" x 10 3/4" x 21-1/2"



Mille Bolle

DESIGN BY ADRIANO RACHELE

technical details p. 474



SOAP BUBBLES, FLEETING EMOTIONS

Soap bubbles, fleeting emotions from the near past captured in a romantic, timeless play of light and weightless reflections. The handcrafted diffuser is a series of small folded iridescent polycarbonate pieces, illuminated by an almost invisible light source.

L'emozione fugace delle bolle di sapone, i ricordi di un passato mai troppo lontano, un romantico gioco di luci e preziosi riflessi senza tempo. Il fascino del diffusore, realizzato a mano piegando ad arte piccoli fogli di policarbonato iridescente, si accende sotto una fonte luminosa quasi invisibile.

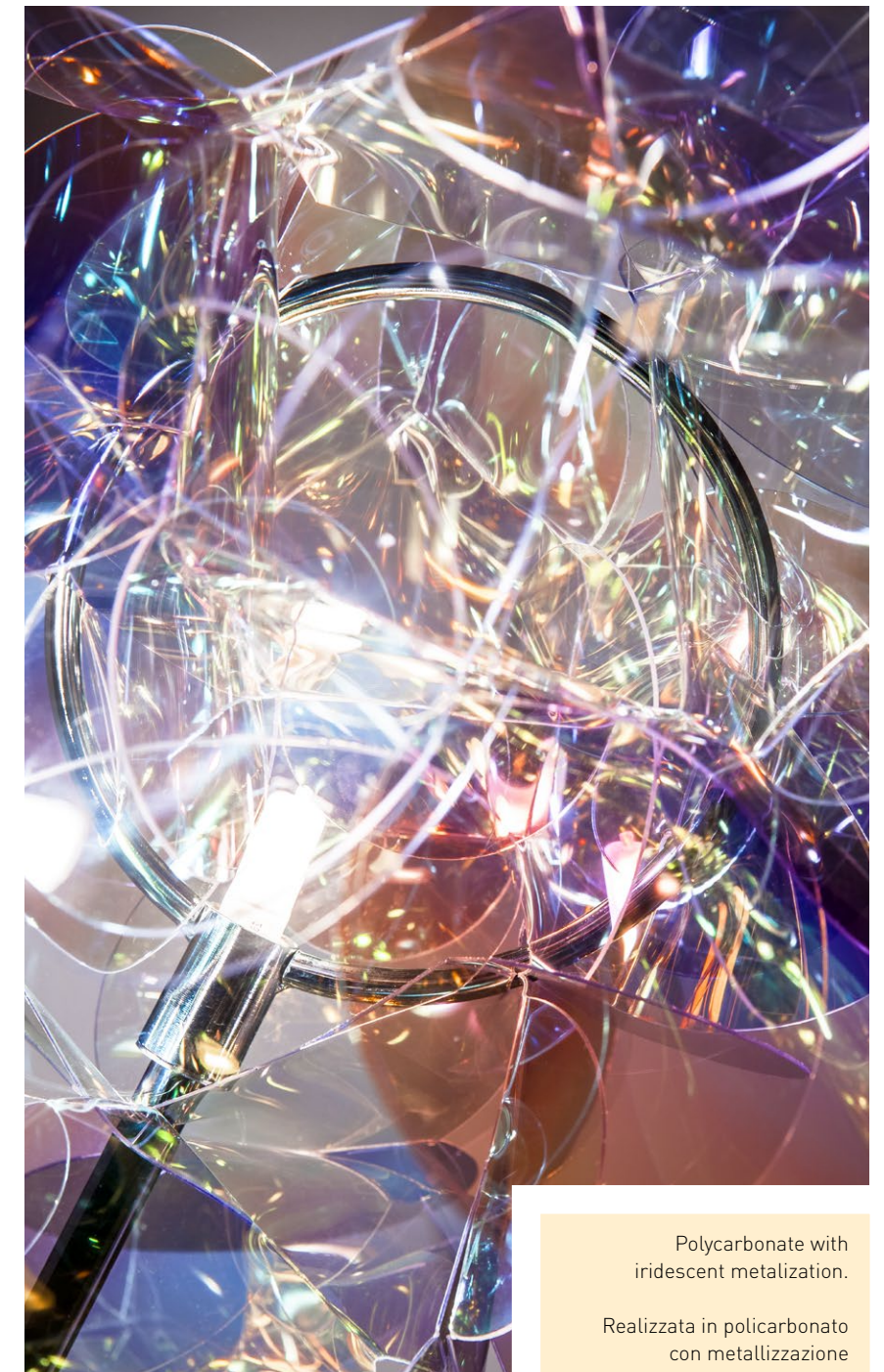

Polycarbonate with iridescent metalization.

Realizzata in policarbonato con metallizzazione iridescente.

Size / Dimensioni:
21 x 29 x h. 41 cm
8" x 112 x h. 16".

SUSPENSION
p.168

WALL LAMP

CEILING LAMP

TABLE LAMP
p.310

FLOOR LAMP
p.438

Bios

DESIGN BY NIGEL COATES

technical details p. 451



DELICATE
LINES,
A FLAIR
FOR THE
NATURAL



Available in 3 sizes/
Disponibili in 3 misure

L: Ø 72 x h. 15 cm
(Ø 28-1/4" x h. 6")

M: Ø 54 x h. 12 cm
(Ø 21-1/4" x h. 4-3/4")

S: Ø 36 x h. 10 cm
(Ø 14-1/4" x h. 4")



SUSPENSION



WALL LAMP



CEILING LAMP
p.238



TABLE LAMP
p.316



FLOOR LAMP
p.434

Venti

DESIGN BY ALESSANDRO MENDINI

technical details p. 480



Available in 3 sizes/
Disponibili in 3 misure

L: Ø 72 x h. 15 cm
(Ø 28-1/4" x h. 6")

M: Ø 54 x h. 12 cm
(Ø 21-1/4" x 4-3/4")

S: Ø 36 x h. 10 cm
(Ø 14-1/4" x h. 4")



LIKE
A
STONE
THROWN
INTO WATER...



ALESSANDRO MENDINI



Dafne

DESIGN BY NIGEL COATES

technical details p. 458



SPROUTED TO A LAUREL LEAF

A nymph transformed into a tree: the myth and images that inspired the name.

Il nome della lampada porta con sé l'immaginario mitico della trasformazione della Ninfa da donna in arbusto.

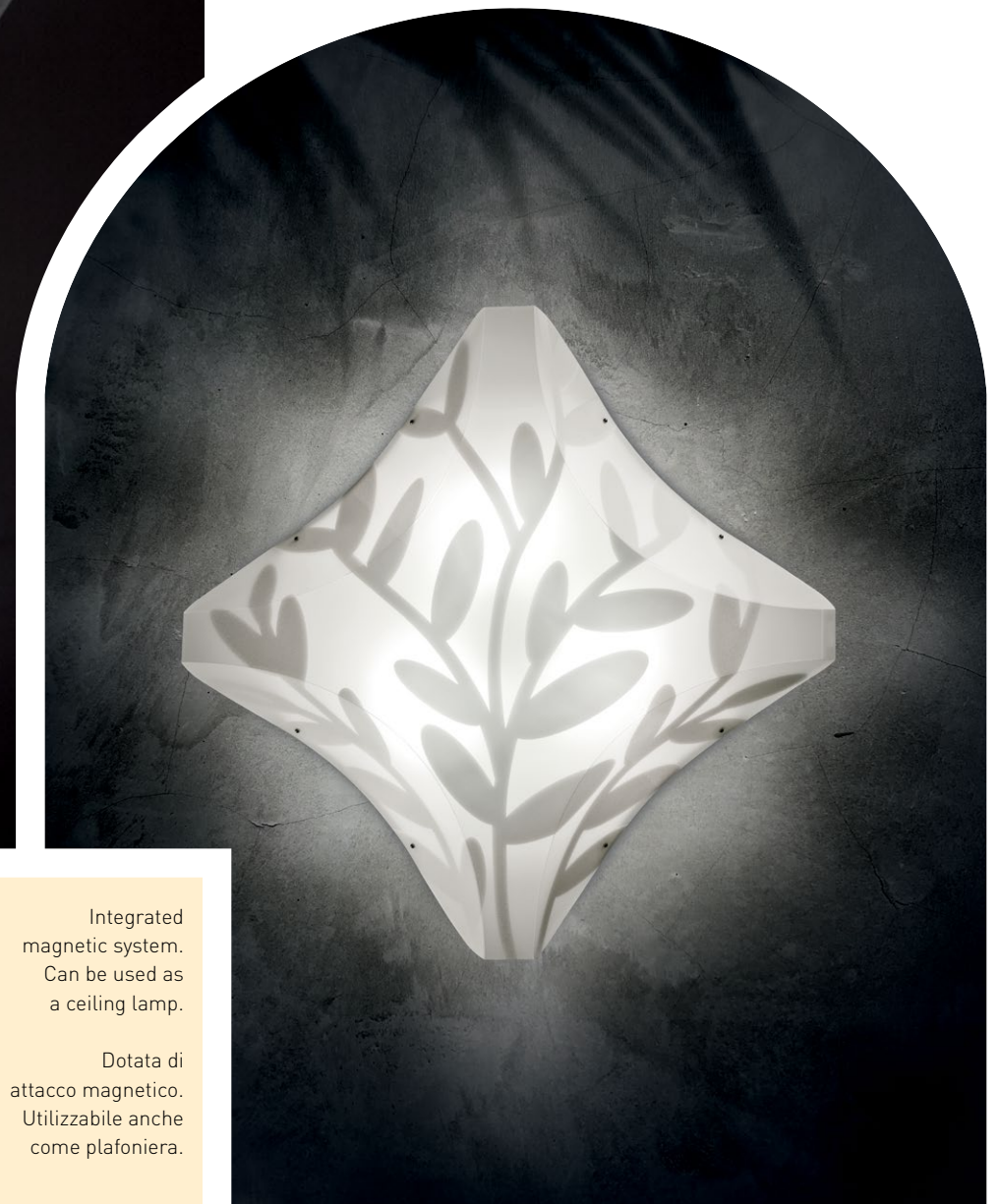

Integrated magnetic system. Can be used as a ceiling lamp.

Dotata di attacco magnetico. Utilizzabile anche come plafoniera.

SUSPENSION
p.160

WALL LAMP

CEILING LAMP
p.240

TABLE LAMP
p.314

FLOOR LAMP
p.434



A CAROUSEL OF LUXURIOUS REFRACTIONS

Semi-radial elements connect to a mirrored steel support, enriched by luxurious transparent crystals that transform a surrounding space into a carousel of reflections.

Realizzata con una struttura semiradiale che si aggancia al supporto in acciaio specchiato, Lilibet è arricchita dalla preziosità dei cristalli trasparenti che creano riflessioni multiformi nell'ambiente circostante.

Fabula

DESIGN BY COSTANTINO MOROSIN

technical details p. 462

A LONG, SILKY PIECE OF FABRIC

Fabula imitates a long, silky piece of fabric knotted around itself. The material's iridescent effects flash thanks to the 60 cm. diameter body's 5 central light sources.

Realizzata a mano concatenando elementi di Lentiflex®, Fabula ricorda una lunga e soffice fascia di seta avvolta su se stessa. Nella versione da 60 cm di diametro, l'effetto cangiante del materiale è reso più scintillante dalle 5 fonti luminose.

Large: Ø 60 cm x 25cm
Ø 23-1/2" x h. 9 -3/4"
5 X 12W E27/E26
LED Filament Bulbs

Small: Ø 48,5 cm x 21cm
Ø 19" x h. 8"
3 X 12W E27/E26
LED Filament Bulbs

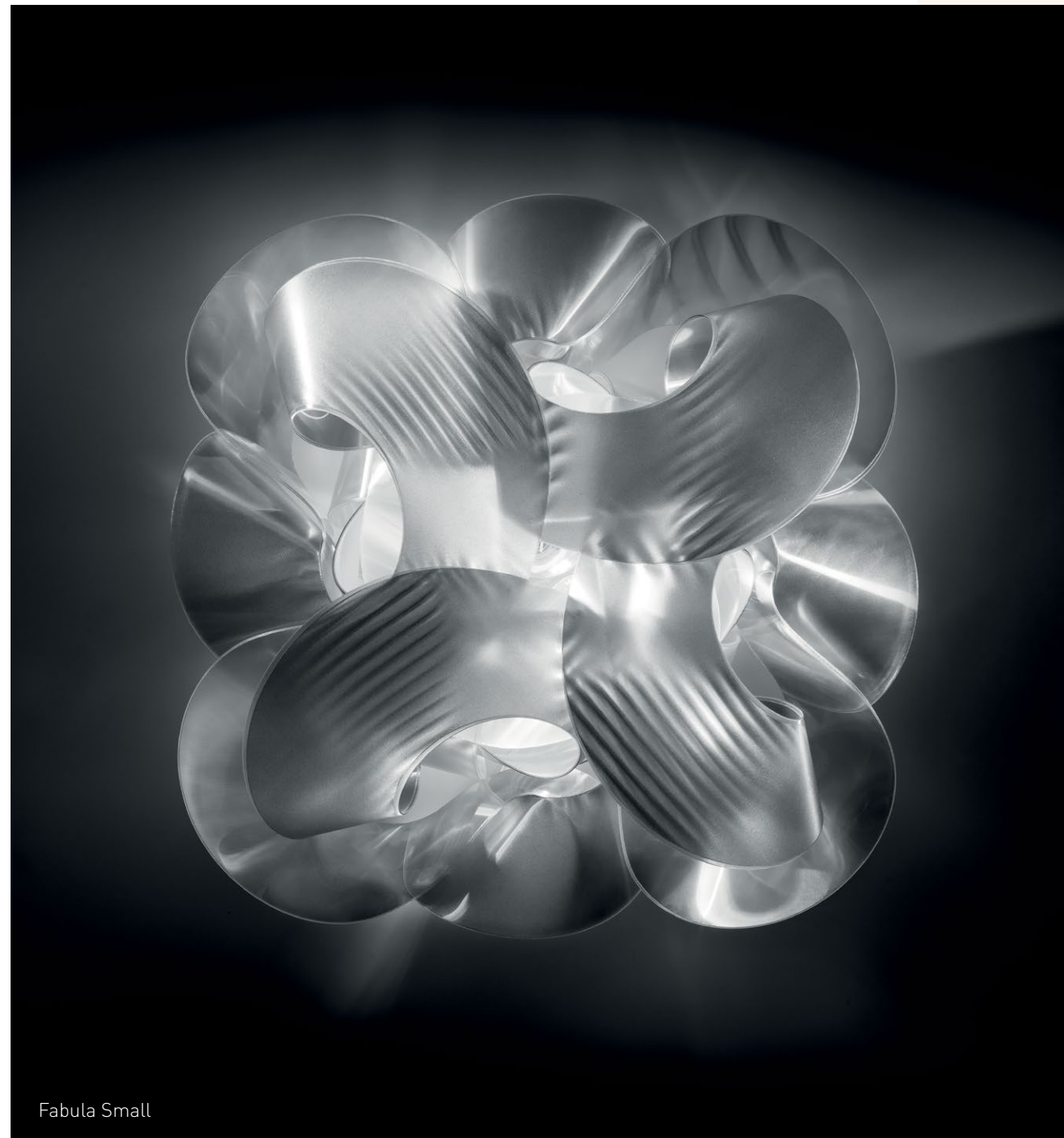

Fabula Small

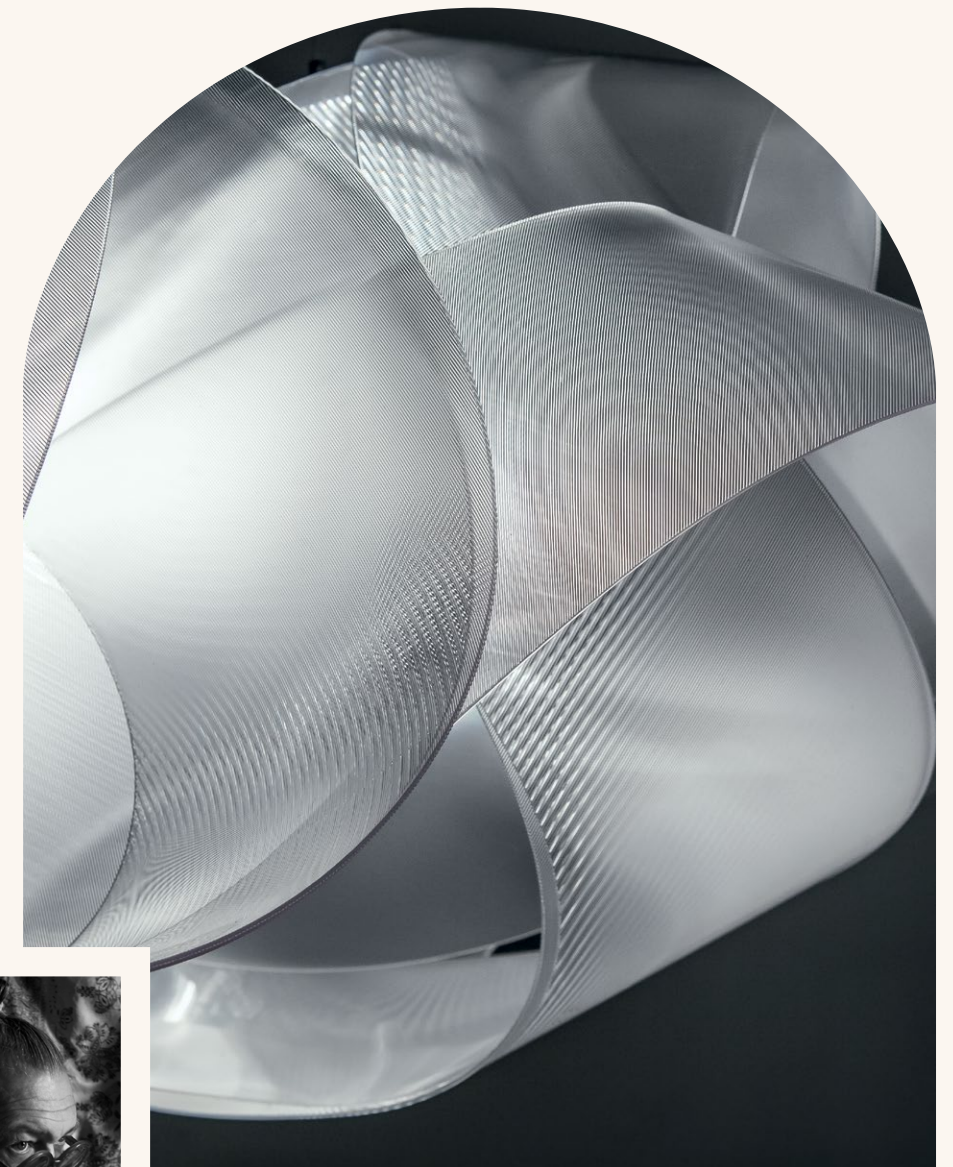

COSTANTINO MOROSIN



SUSPENSION
p.148



WALL LAMP



CEILING LAMP
p.234



TABLE LAMP



FLOOR LAMP

Fiorella Mini

DESIGN BY NIGEL COATES

technical details p. 463



Size / Dimensioni:
34 x 22x h.19 cm
3-1/2" x 8-3/4" x h. 7-1/2"

Available in White
(close-up left) and
Fumè (pictured right).

Disponibile sia White
(dettaglio a sinistra)
che Fumè (a destra).

Medusa

DESIGN BY NIGEL COATES

technical details p. 473



Medusa Black

A DRAMATIC COLLECTION

Inspired by classic, crystal-clad chandeliers, Medusa has an internal mirrored vessel that enhances the light extending from 4 surrounding arms.

Ispirata ai classici lampadari con cristalli, Medusa è dotata di un cestello specchiato che enfatizza la luce e di 4 braccia che l'avvolgono.



Medusa Blue Gel

- 
 SUSPENSION
 p.158
- 
 WALL LAMP
- 
 CEILING LAMP
- 
 TABLE LAMP
- 
 FLOOR LAMP



-  SUSPENSION
p.144
-  WALL LAMP
-  CEILING LAMP
-  TABLE LAMP
-  FLOOR LAMP



DIMMABLE WITH SOFT TOUCH

The design and bend of the floor lamp were inspired by the outreached hands of Michelangelo's "Last Judgement" in the Sistine Chapel. The light touch dimming system is ergonomically placed, and blinks when the lamp is at minimum and maximum brightness.

L'inclinazione e il design della lampada da terra sono ispirati al tocco delle mani dei protagonisti del Giudizio Universale, il dipinto di Michelangelo nella Cappella Sistina. Il sistema di dimmerazione a sfioramento, collocato in posizione ergonomica, lampeggia quando raggiunge il punto massimo e minimo d'intensità luminosa.



PLAY VIDEO





Size / Dimensioni:
9 x h. 207 cm, base Ø 32 cm
3-1/9" x h.80-3/4", base Ø 12-1/2"

Soft touch dimming system
(0-100) with ergonomically
placed button.

Sistema di dimmerazione 0-100
con pulsante soft touch in
posizione ergonomica

Charlotte

BY DORIANA AND MASSIMILIANO FUKSAS

technical details p. 455



UNENDING VIEWS

Charlotte seems to be moulded from a single shape, with rigorous, impalpable patterns that draw the eye in. Concentric, hexagonal forms hypnotise, giving a new point of view from every luminous angle.

Charlotte sembra modellarsi da un unico volume con una trama laboriosa, a tratti impalpabile, come quella del nido d'ape, attraverso cui è permesso addentrarsi tramite forme esagonali concentriche per avere una prospettiva ipnotica e sempre nuova da ogni punto di osservazione.



DORIANA AND MASSIMILIANO FUKSAS

-  SUSPENSION
p.60
-  WALL LAMP
p.332
-  CEILING LAMP
-  TABLE LAMP
-  FLOOR LAMP



Size / Dimensioni:
Ø 32 x h.182 cm
Ø 12-1/2" x h. 71-3/4"

Lighting / Illuminazione:
2 x 12W Dimmable
LED Bulbs E27/E26



zanini— de zanine

LIGHT EVOKES A SPACE'S ATMOSPHERE

I have always wanted my style to reflect my homeland in Brazil through global exchanges, technological experimentation, and the fusion of handcrafted process applied to industrial design. These design approaches have allowed me, over time, to translate my country's culture and identify the unmistakable characteristics intrinsic to each object: proportion and functionality. A lighting installation should enrich a space, giving it aesthetic value and functional ease. Light should bring beauty to the object that houses it, respecting the object's identity and the necessities of those who have chosen it for their personal space.

Ho sempre voluto rendere il mio stile riconducibile alla mia terra, il Brasile, attraverso le connessioni create grazie agli scambi oltreoceano, alla sperimentazione di nuove tecnologie e alla fusione dell'artigianato con l'industrial design. Questo è ciò che nel tempo mi ha permesso di tradurre con il design la cultura del mio Paese e di individuare le caratteristiche imprescindibili che ogni oggetto dovrebbe avere: proporzione e funzionalità. Un'installazione luminosa dovrebbe arricchire lo spazio e conferirgli valore in termini di comfort, sia estetico che funzionale. La luce deve trasmettere la bellezza dell'oggetto che la propaga, nel rispetto dell'identità dell'oggetto stesso e nel rispetto dell'esigenza di chi la cerca nello spazio che vuole vivere.

Flora

DESIGN BY ZANINI DE ZANINE

technical details p. 463



Flora Gold



Flora Pewter

Size / Dimensioni:
Ø 50 cm x h. 170 cm
Ø 19-3/4" x h. 67"

Lighting / Illuminazione:
3 x 12W Dimmable
LED Bulbs E27/E26





Flora White

INSPIRED BY THE MONSTERA DELICIOSA PLANT

Sixty petals surround a satin sphere illuminated from its core. The lamp is available both as a suspension version, as well as a ground version resting on thin legs that resemble a flower's pistils.

60 petali avvolgono la sfera satinata, cuore lucente della lampada disponibile sia in versione a sospensione, che nella versione da terra dotata di sottili steli che ricordano i pistilli di un fiore.

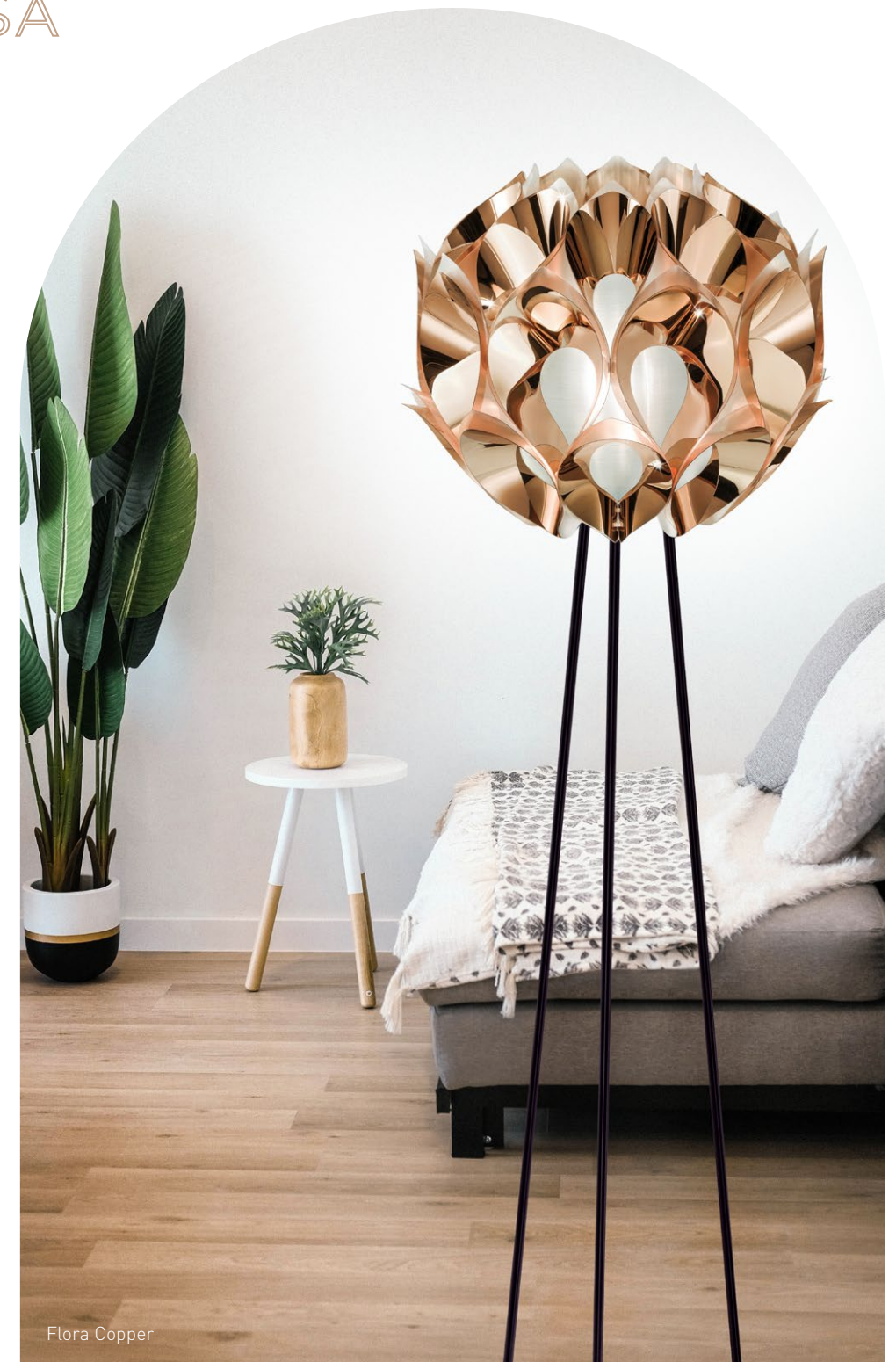

Flora Copper

La Lollo

DESIGN BY LORENZA BOZZOLI

technical details p. 470



GLASS? NO THANK YOU. IT'S ALL ABOUT GREEN

An elegant, refined column that resembles blown glass from Murano : high tech, unbreakable, easily transported, and highly sophisticated. The lamp is produced with a reduced carbon footprint, and the cuttings are recycled into portable beehives.

Una colonna di luce elegante e raffinata, che ricorda la trama del vetro cannettato della tradizione muranese e la ripropone in una versione high-tech, infrangibile, facilmente trasportabile e sofisticata. Realizzata a basso impatto ambientale e trasformando gli sfridi di lavorazione in arnie per le api.



-  SUSPENSION
p.84
-  WALL LAMP
p.334
-  CEILING LAMP
-  TABLE LAMP
-  FLOOR LAMP



Size / Dimensioni:
Ø13 cm x h. 163 (base Ø29 cm)
Ø5" x h.63-1/2" (base Ø 11-1/4")

Lighting / Illuminazione:
3 x 12W LED Filament
dimmable bulbs E27/E26

Con dimmer/ with dimmer



studio — job

LIGHT IS LIFE

Our work is inspired by Life itself and the heroes of our youth: David Bowie, Miffy, Roy Lichtenstein, The Green Vault, Warhol and many others... Now, for the first time, our iconic artwork has been applied to 7 Slamp lamps; unlike other design objects, the good vibrations of this shining soul emanate from within. Light is life, and this new collection "The Lightning Archives of Studio Job" is a superduper scoop! Collect them all :-)

Il nostro lavoro si ispira alla vita e agli eroi che hanno fatto parte della nostra giovinezza: David Bowie, Miffy, Roy Lichtenstein, il Green Vault, Warhol e molti altri... Oggi, per la prima volta, con la collezione di 7 prodotti per Slamp, vediamo i nostri pattern più iconici nascere su una lampada, un'anima luminosa che non necessita di essere illuminata dall'esterno come gli altri oggetti di design e che emana buone vibrazioni. La luce è vita e la nuova collezione di lampade "The Lightning Archives of Studio Job" è un superduper scoop!

THE Lightning Archives

OF STUDIO JOB

technical details p. 476



Love Peace Joy



Perished

- 
 SUSPENSION
- 
 WALL LAMP
- 
 CEILING LAMP
- 
 TABLE LAMP
- 
 FLOOR LAMP



STUDIO JOB



Faena Art

STUDIO JOB'S ODE TO A SLAMP MASTERPIECE

An iconographic grammar created from Dadaist derivatives drove Studio Job to write an ode to Slamp's original masterpiece from the 90's, the Tube. The collection narrates their poetry, aura, history, and daring design.

Con una grammatica iconografica di derivazione dadaista, Studio Job scrive un'ode al Tube - masterpiece di Slamp degli anni '90 - per narrarne la poeticità, l'aura, la storia e l'audacia decorativa.

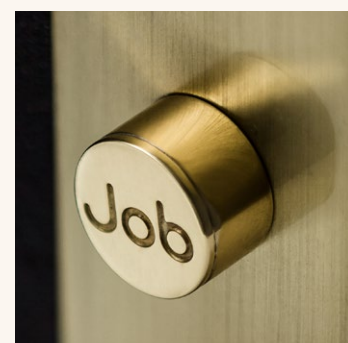

Peace Skull



Faena Art



L'Afrique



Bananas



Labyrinth



Perished



Love Peace Joy



Bach

DESIGN BY FRANCESCO PARETTI

technical details p. 450



Size / Dimensioni XXL:
Ø 31,5 cm x h. 184 cm
Ø 12-1/2" x h. 72-1/2"

Size / Dimensioni XL:
Ø 31,5 cm x h. 161 cm
Ø 12-1/2" x h. 63-1/2"



SUSPENSION



WALL LAMP



CEILING LAMP



TABLE LAMP
p.298



FLOOR LAMP



Colours: Gold and White
Available in floor (3 sizes)
and table (2 sizes) versions

Colori: Gold e White
Disponibile in 3 dimensioni
da terra e 2 da tavolo



WELCOMING NOOKS FILLED WITH WARM CHROMATICS

Slim and refined, Bach is statuary, with elegant yet rigorous curves, bringing fluid, linear movement and illumination to any interior.

Snella e raffinata, Bach è uno corpo statuario e dalle tinte chiare. Le sue eleganti ma rigorose forme si legano alle moderne curvature capaci di seguire perfettamente le linee di ogni ambiente architettonico



Clizia Fumè

TRANSFORMS A SPACE INTO A LANDSCAPE

The perfect balance of transparent folds that continuously cast reflections. Inspired by natural shapes, the floor lamp is a flurry that captures the first rays of the sun, transforming them into a complex, iridescent glow.

Forme regolari incastrate in un perfetto equilibrio di trasparenze e riflessi compongono il design di Clizia. La lampada da terra riprende le forme della natura: è una nuvola che cattura la luce del sole delle prime ore del giorno e si carica di riflessi cangianti.



Clizia White

Size / Dimensioni:
 Ø 63 cm x h. 164 cm
 Ø 24-3/4" x h. 64"

Available in 4 colours.
 Disponibile in 4 colori.



SUSPENSION
p.78



WALL LAMP
p.350



CEILING LAMP
p.224



TABLE LAMP
p.278



FLOOR LAMP

Liza

DESIGN BY ELISA GIOVANNONI

technical details p. 472



Ph. Roberto Costantini
Courtesy of Scarabeo Ceramiche



Size / Dimensioni:
Ø 45 cm x h. 170 cm - Ø 17-1/2" x h. 67"

A reading companion: the diffusor rotates up to 220°, illuminating every part of your space.

Ideale lampada da lettura: permette di ruotare il diffusore di 220° per portare la luce ovunque sia necessario, come al lato di un sofa.

-  **SUSPENSION**
p.154
-  **WALL LAMP**
-  **CEILING LAMP**
-  **TABLE LAMP**
p.280
-  **FLOOR LAMP**

Cactus

DESIGN BY ADRIANO RACHELE

technical details p. 453



Hand-inserted folds transform into an ironic, irreverent lamp, available in two floor and two table sizes.

Incastri eseguiti a mano per una lampada ironica e irriverente disponibile in 2 misure da terra e 2 da tavolo.



SUSPENSION
p.174



WALL LAMP



CEILING LAMP



TABLE LAMP
p.300

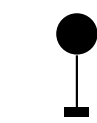

FLOOR LAMP

Cactus

PRISMA
DESIGN BY ADRIANO RACHELE



EXTRA-
ORDINARY
ABILITY
TO
ADAPT
TO ANY
SPACE

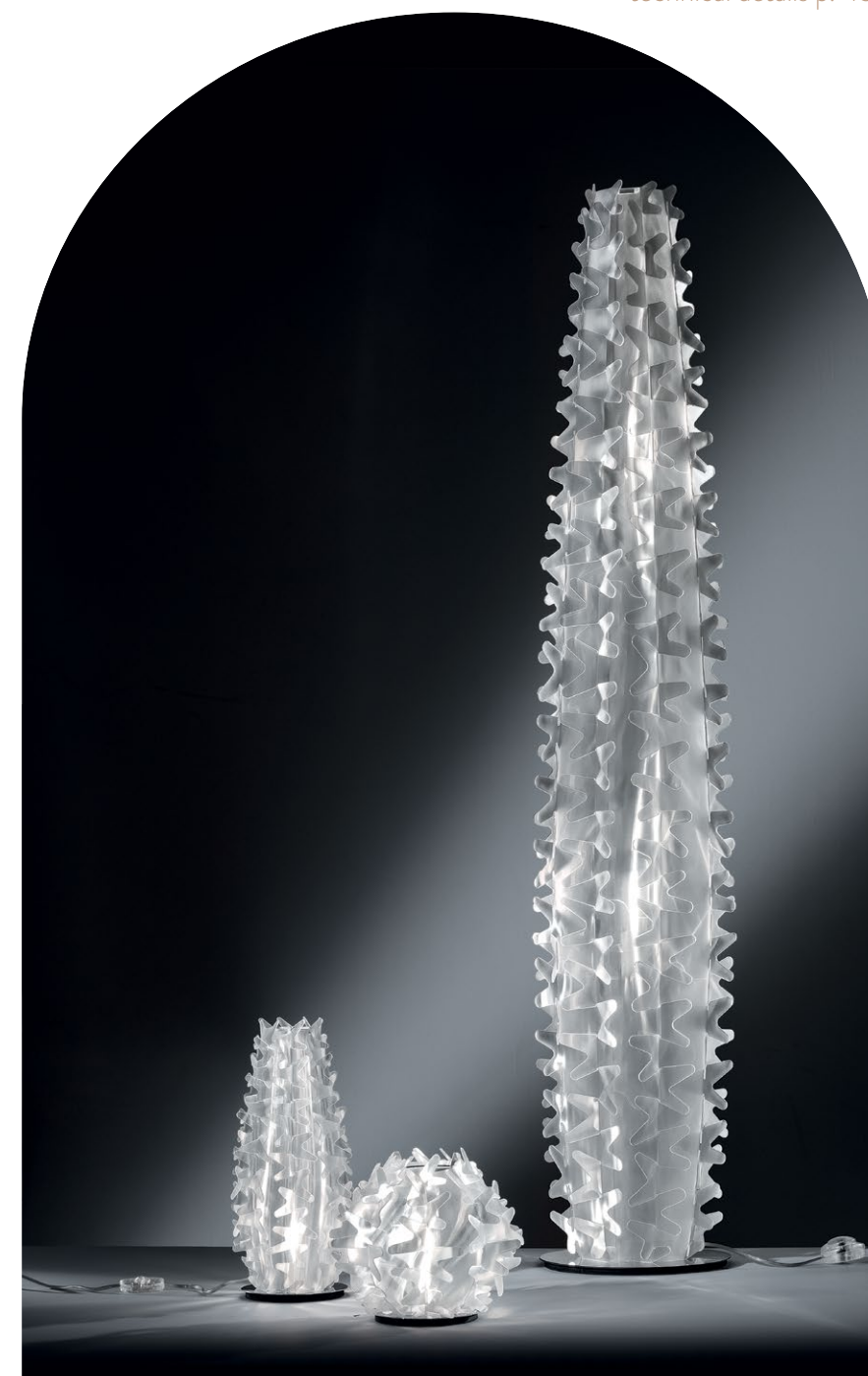

technical details p. 452

Las Palmas

DESIGN BY JONAS CLEMENTONI

technical details p. 471

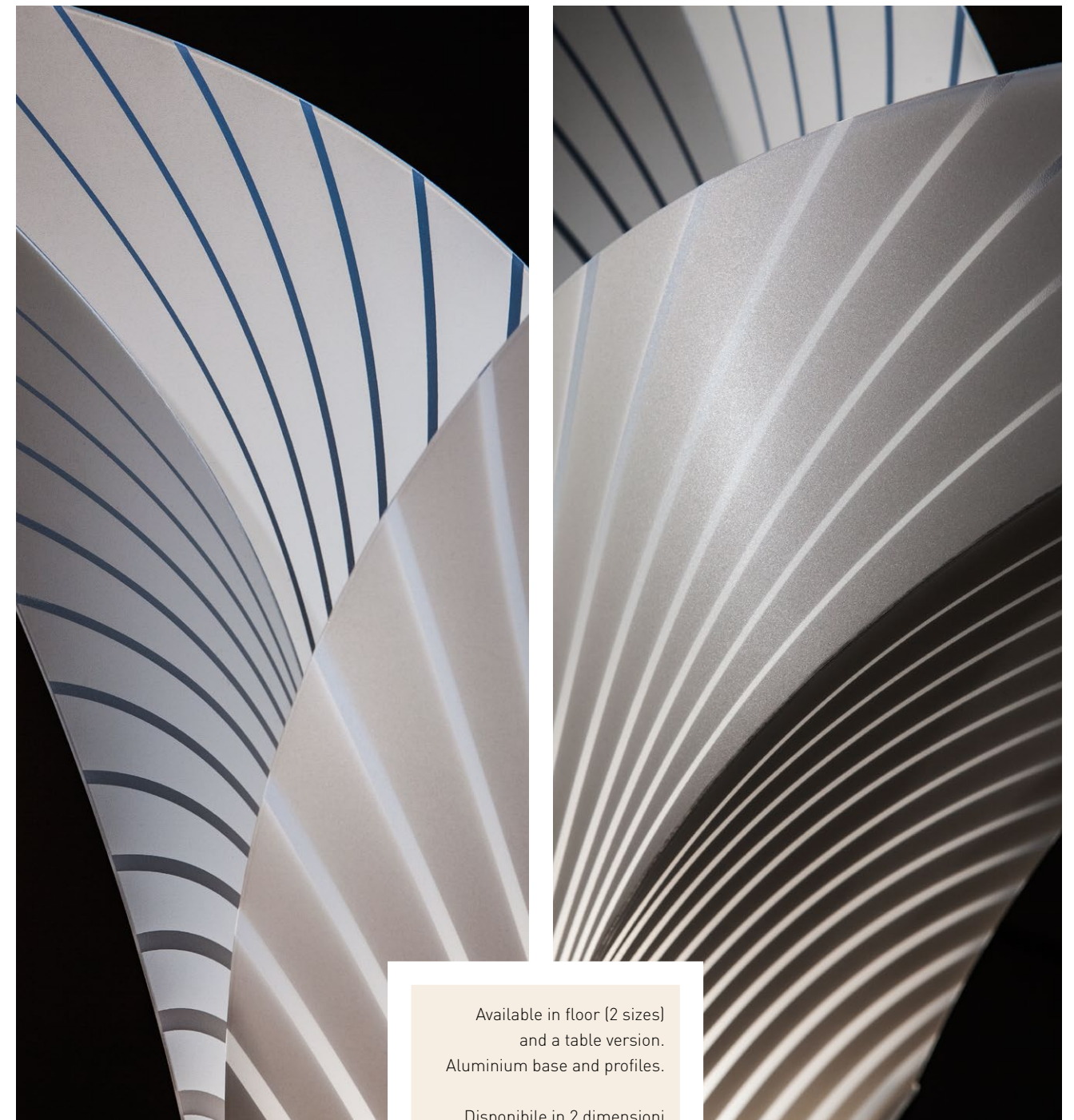

Available in floor (2 sizes)
and a table version.
Aluminium base and profiles.

Disponibile in 2 dimensioni
da terra e 1 da tavolo.
Base e profili in alluminio.



Gemmy

BY RAGNISCO, SPALLETTA, CROCE, WIJIFFELS

technical details p. 464



Gemmy Prisma



SUSPENSION
p.162



WALL LAMP



CEILING LAMP



TABLE LAMP
p.304



FLOOR LAMP



Amber

Amethyst

Prisma Gold

Available in five prismatic
colour selections, all with a
white base and arm.

Disponibile in 5 colori
prismatici, tutti con
asta e base bianca.

Ecstacity

DESIGN BY NIGEL COATES

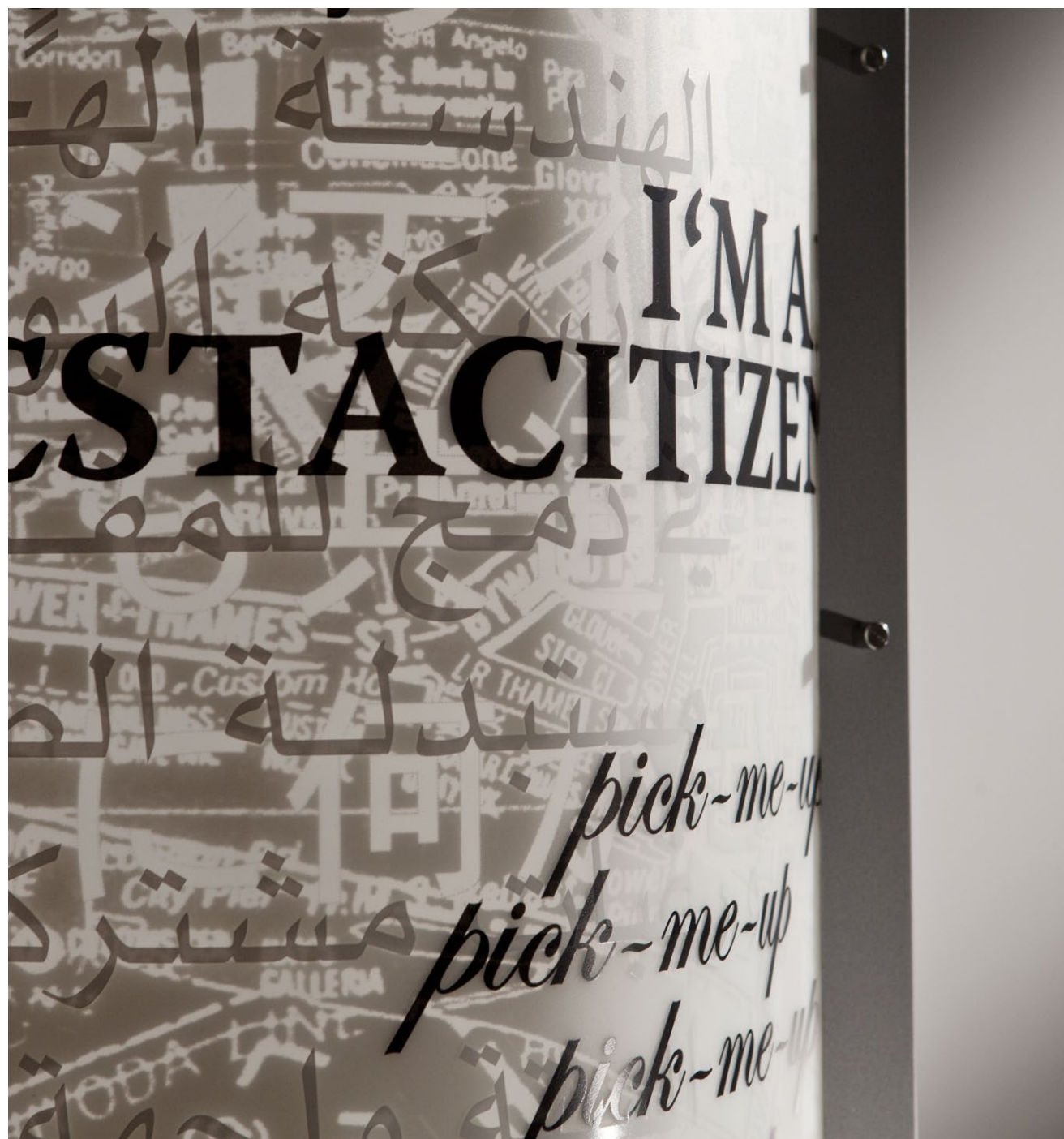

DESIGN TAKEN STRAIGHT FROM THE PAGES

Ecstacity is Nigel Coates' three-dimensional version of the architecture described in his book of the same name. Just as his edition made space for an ideal, non-linear imaginary city, the design plays on a series of superimposed graphic printing.

Ecstacity è la realizzazione tridimensionale del concept sull'architettura racchiuso all'interno dell'omonimo libro di Nigel Coates. Esattamente come nel volume si dà spazio all'immaginario di una città ideale incoraggiando una lettura non lineare, allo stesso modo in questa lampada si gioca con una serie di stampe serigrafiche sovrapposte.



Aluminium sides.
Dimmer included.

Profili in alluminio.
Dimmer incluso.

Size/Dimensioni:
37 x 21 x h. 160 cm
14-1/2" x 8-1/4" x h. 63"



SUSPENSION

WALL LAMP

CEILING LAMP

TABLE LAMP

FLOOR LAMP

Fiorella

DESIGN BY NIGEL COATES

technical details p. 463



Available in 2 colours:
fumè and white (pictured).
Polished steel arm
and base.

Disponibile in 2 colori:
fumè e white (in foto).
Asta e base in
acciaio lucido.



SUSPENSION
p.180



WALL LAMP
p.382



CEILING LAMP



TABLE LAMP
p.294



FLOOR LAMP



FLOOR LAMP

Dafne

DESIGN BY NIGEL COATES

technical details p. 458



NIGEL COATES

- 
 SUSPENSION
p.160
- 
 WALL LAMP
p.376
- 
 CEILING LAMP
p.240
- 
 TABLE LAMP
p.314
- 
 FLOOR LAMP

Bios

DESIGN BY NIGEL COATES

technical details p. 451

TONAL SHADES,
TINY INCISIONS,
SUGGESTIVE
ILLUMINATION



Bios has two layers of Opalflex®, both with carefully selected incisions that let the light shine through, creating suggestive reflections and shadows.

Bios nasce dalla sovrapposizione di due strati di Opalflex® dai quali, attraverso i fori irregolari, filtra una luce che crea suggestivi riflessi e un particolare gioco di luci e di ombre



SUSPENSION



WALL LAMP
p.372



CEILING LAMP
p.238



TABLE LAMP
p.316



FLOOR LAMP

Venti

DESIGN BY ALESSANDRO MENDINI

technical details p. 481



AN
ALESSANDRO
MENDINI
MASTERPIECE,
FROM THE 90'S



SUSPENSION



WALL LAMP
p.374



CEILING LAMP
p.244



TABLE LAMP
p.308



FLOOR LAMP

Mille Bolle

DESIGN BY ADRIANO RACHELE

technical details p. 474



Suggestive, poetic effects that evoke soap bubbles floating in the air.

Effetti iridescenti poetici e suggestivi, come quelli delle bolle di sapone appena soffiate nell'aria.

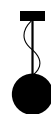

SUSPENSION
p.168



WALL LAMP
p.370



CEILING LAMP



TABLE LAMP
p.310



FLOOR LAMP

Diamond

DESIGN BY PAOLUCCI, STATERA

technical details p. 459



INSPIRED
BY THE
ICONIC WORKS
OF BRANCUSI



Size / Dimensioni:
L: 27 x 26 x h. 11 cm
10-1/2" x 10" x h. 43-3/4"

M: 22 x 23 x h. 72 cm
8-1/2" x 9" x h 28-1/4"

With brushed aluminium base.
Base in alluminio satinato.



SUSPENSION

WALL LAMP

CEILING LAMP

TABLE LAMP
p.306

FLOOR LAMP

Atlante

DESIGN BY NIGEL COATES

technical details p. 447



Size / Dimensioni:

Ø 51 cm x h. 85 cm

Ø 20" x h. 33-1/2"

Illuminazione / Luce:

8 X 15W max IBC/C bulbs.



SUSPENSION
p.170



WALL LAMP



CEILING LAMP



TABLE LAMP



FLOOR LAMP

TECHNICAL DETAILS | DETTAGLI TECNICI

ACCORDÉON SUSPENSION

LED: 52W 100 ~ 240V - 5.900 Lumen
 2700 Kelvin or 3000 Kelvin
 220V version dimmable with PWM / 0-10 or Potentiometer
 110V version Dimmable with: Triac
 Additional dimming system Dali, Bluetooth, Casambi, Triac upon request
 MADE OF: Lentiflex® / Goldflex® / Steelflex®

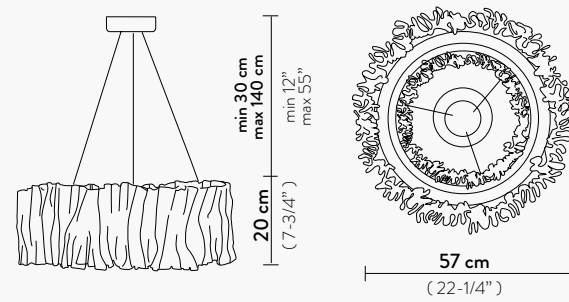

COLOURS:

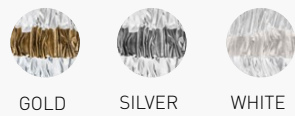

GOLD SILVER WHITE

ACCORDÉON TABLE

2 X 12W LED Filament Bulbs E27/E26
 + 1 X 6W LED Filament Bulbs E14/E12
 MADE OF: Lentiflex® / Cristalflex®
 WITH: Two Position Light Switch - Magnetic System

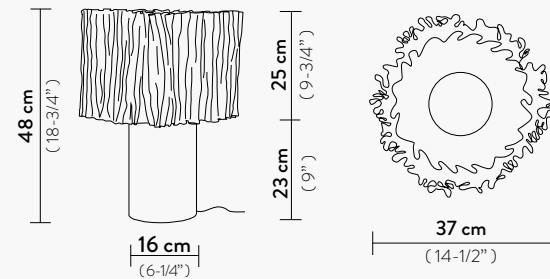

COLOURS:



PRISMA



2 INDEPENDENT LIGHT SOURCES

ARIA XL BLACK FADE

6 X 12W LED Filament Bulbs E27/E26
 + 1 X 16W Spot LED Bulbs E27/E26
 MADE OF: Cristalflex®

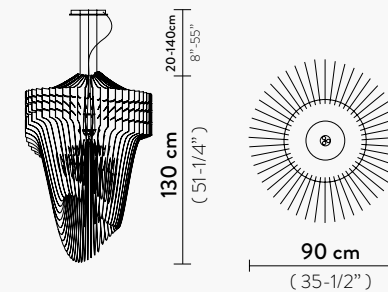

COLOURS:



BLACK FADE

ATLANTE SUSPENSION

8 X 15W max IBC/C Bulbs E14/E12
 MADE OF: Cristalflex®

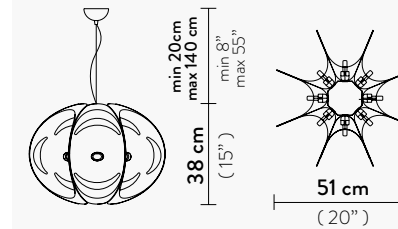

COLOURS:



FUMÉ

ATLANTE FLOOR

8 X 15W max IBC/C Bulbs E14/E12
 MADE OF: Cristalflex®

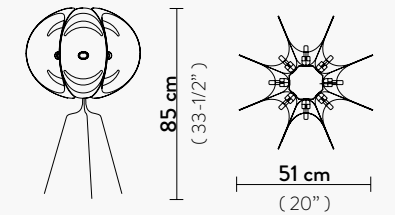

COLOURS:



FUMÉ

ARIA SUSPENSION S

LED: 35W - 220V - 3.500 Lumen
 2700 Kelvin (warm white) CRI 90
 Triac Dimmable (Trailing Edge min. 20W)
 MADE OF: Cristalflex® / Lentiflex®

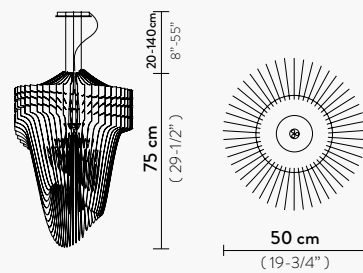

COLOURS:

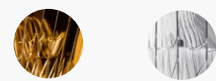

GOLD TRANSPARENT

ARIA SUSPENSION M

LED: 35W - 220V - 3.500 Lumen
 2700 Kelvin (warm white) CRI 90
 Triac Dimmable (Trailing Edge min. 20W)
 MADE OF: Cristalflex® / Lentiflex®

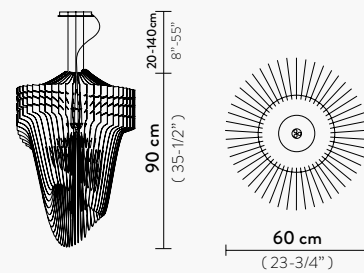

ARIA SUSPENSION L

LED: 70W - 220V - 7.000 Lumen
 2700 Kelvin (warm white) CRI 90
 Triac Dimmable (Trailing Edge min. 20W)
 MADE OF: Cristalflex® / Lentiflex®

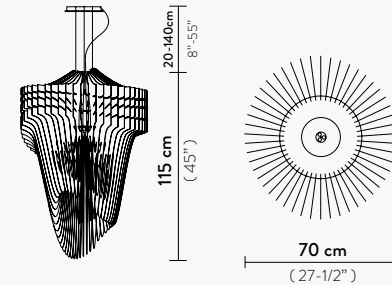

ATMOSFERA SUSPENSION

2 X 12W LED Filament Bulbs E27/E26
 MADE OF: Methacrylate / Goldflex®
 or Pewterflex®
 WITH: Hand - finished Sphere

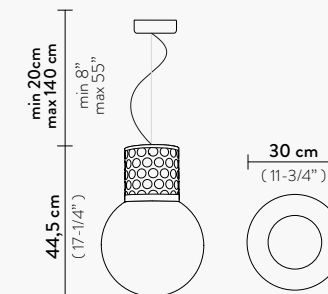

COLOURS:

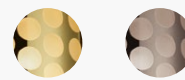

GOLD PEWTER

ATMOSFERA TABLE MEDIUM

2 X 12W LED Filament Bulbs E27/E26
 MADE OF: Methacrylate / Goldflex®
 or Pewterflex®
 WITH: Hand - finished Sphere

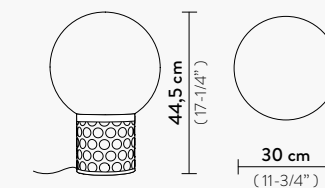

COLOURS:

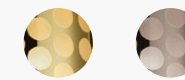

GOLD PEWTER

ATMOSFERA TABLE SMALL

2 X 6 W LED Bulb G9
 MADE OF: Methacrylate / Goldflex®
 or Pewterflex®
 WITH: Hand - finished Sphere

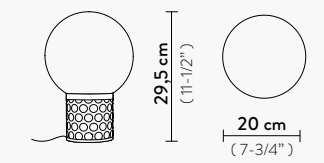

2 INDEPENDENT LIGHT SOURCES

**ATMOSFERA FRINGE
TABLE MEDIUM**

2 X 12W LED Filament Bulbs E27/E26
MADE OF: Methacrylate / Goldflex® or Pewterflex®
WITH: Hand - finished Sphere

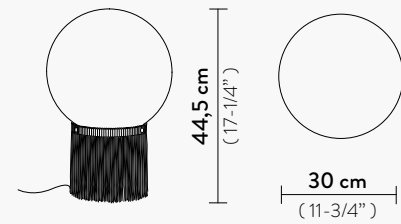

**ATMOSFERA FRINGE
TABLE SMALL**

2 X 6 W LED Bulb G9
MADE OF: Methacrylate / Goldflex® or Pewterflex®
WITH: Hand - finished Sphere

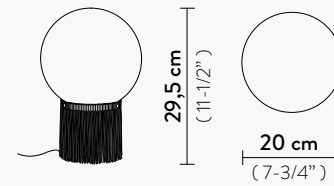

COLOURS:

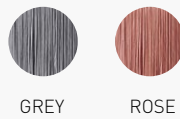

2 INDEPENDENT
LIGHT SOURCES

AVIA SUSPENSION XL

6 X 12W LED Filament Bulbs E27/E26
+ 1 X 16W Spot LED Bulb E27/E26
MADE OF: Cristalflex® / Lentiflex®

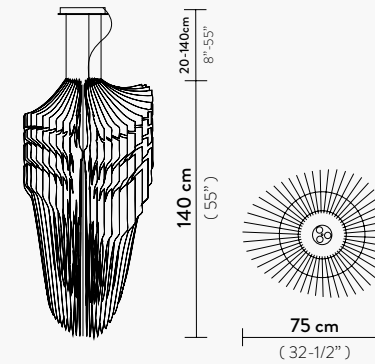

AVIA SUSPENSION L

4 X 12W LED Filament Bulbs E27/E26
+ 1 X 16W Spot LED Bulb E27/E26
MADE OF: Cristalflex® / Lentiflex®

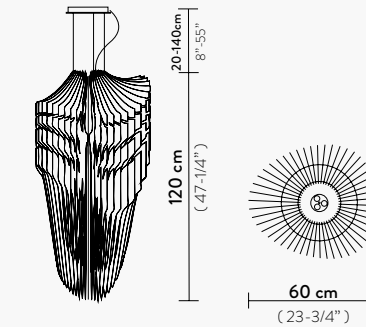

AVIA SUSPENSION M

3 X 12W LED Filament Bulbs E27/E26
+ 1 X 11W Spot LED Bulbs E27/E26
MADE OF: Cristalflex® / Lentiflex®

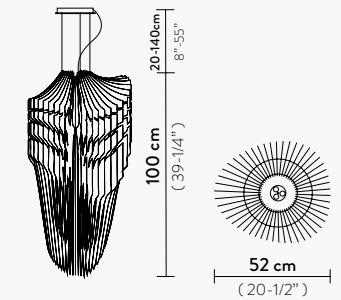

COLOURS:

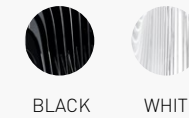

AVIA SUSPENSION S

2 X 12W LED Filament Bulbs E27/E26
+ 1 X 11W Spot LED Bulbs E27/E26
MADE OF: Cristalflex® / Lentiflex®

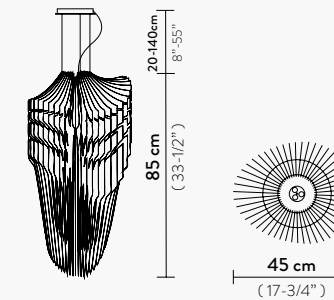

COLOURS:

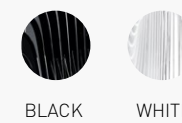

AVIA EDITION M

A LIMITED SERIES OF 99 PIECES PER COLOUR

3 X 12W LED Filament Bulbs E27/E26
+ 1 X 11W Spot LED Bulbs E27/E26
MADE OF: Cristalflex® / Lentiflex®

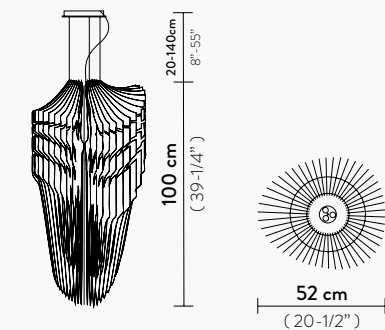

COLOURS:

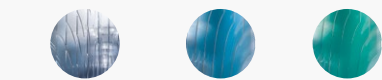

ULTRAMARINE
SOLD OUT

BLUE
LIMITED
AVAILABILITY

TURQUOISE
LIMITED
AVAILABILITY

AURORA CEILING L

1 X 12W LED Filament Bulb E27/E26
MADE OF: Plainflex® / 97 Crystals
WITH: Magnetic System®

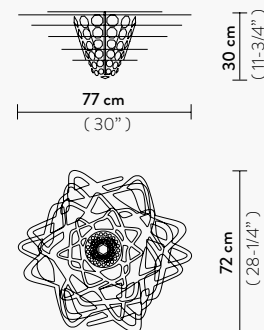

AURORA CEILING MINI

1 X 12W LED Filament Bulb E27/E26
MADE OF: Plainflex® / 61 Crystals
WITH: Magnetic System®

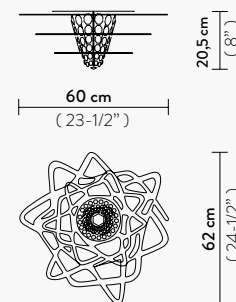

MAGNETIC
SYSTEM

COLOURS:

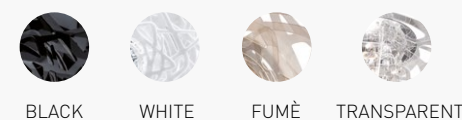
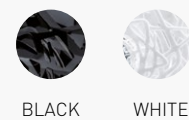

BACH FLOOR XXL

3 X12W LED Filament Bulbs E27/E26
MADE OF: Opalflex®
WITH: Stainless Steel base - Dimmer

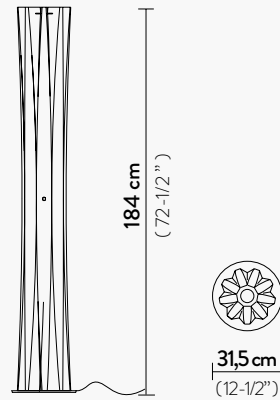

BACH FLOOR XL

3 X12W LED Filament Bulbs E27/E26
MADE OF: Opalflex®
WITH: Stainless Steel base - Dimmer

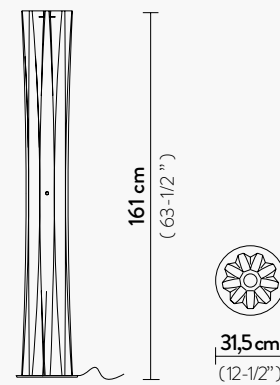

BACH FLOOR L

2 X12W LED Filament Bulbs E27/E26
MADE OF: Opalflex®
WITH: Stainless Steel base

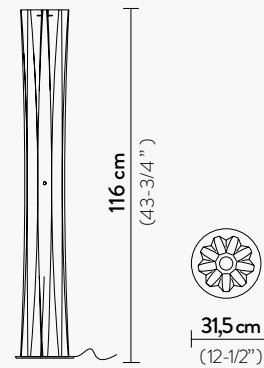

COLOURS:



BACH TABLE M

1 X 12W LED Filament Bulb E27/E26
MADE OF: Opalflex®
WITH: Stainless Steel base

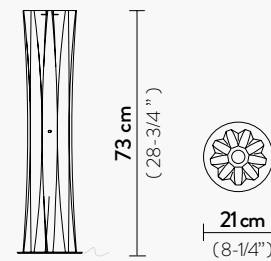

BACH TABLE S

1 X 6W LED Filament Bulb E14/E12
MADE OF: Opalflex®
WITH: Stainless Steel base

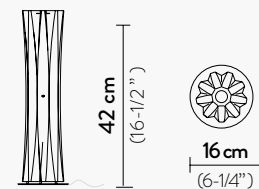

COLOURS:

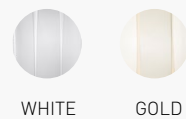

BIOS CEILING/WALL L

4 X 12W LED Filament Bulbs E27/E26
MADE OF: Opalflex®
WITH: Magnetic System®

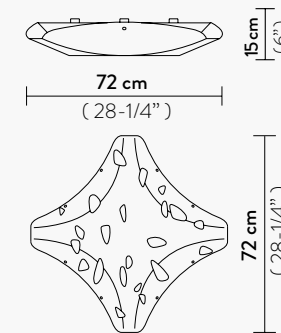

BIOS CEILING/WALL M

3 X 12W LED Filament Bulbs E27/E26
MADE OF: Opalflex®
WITH: Magnetic System®

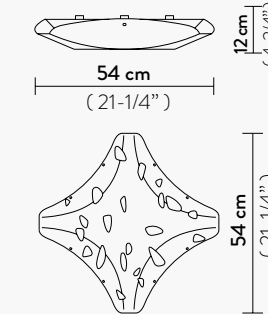

BIOS CEILING/WALL S

2 X 12W LED Filament Bulbs E27/E26
MADE OF: Opalflex®
WITH: Magnetic System®

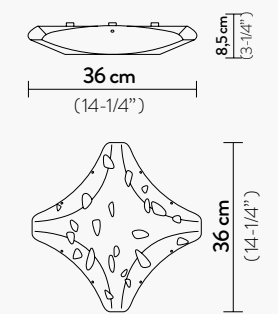

COLOURS:



BIOS FLOOR

3 X12W LED Filament Bulbs E27/E26
MADE OF: Opalflex®
WITH: Dimmer

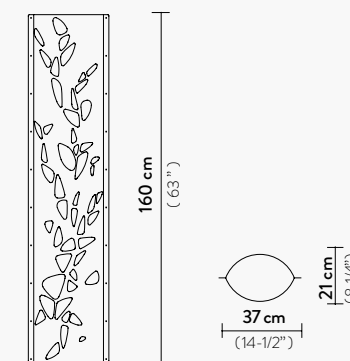

COLOURS:

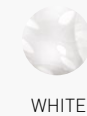

BIOS TABLE

1 X 6W LED Filament Bulb E14/E12
MADE OF: Opalflex®

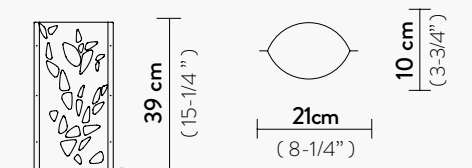

COLOURS:

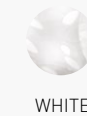

CACTUS PRISMA FLOOR XL

2 X12W LED Filament Bulbs E27/E26
MADE OF: Lentiflex®
WITH: Stainless Steel base

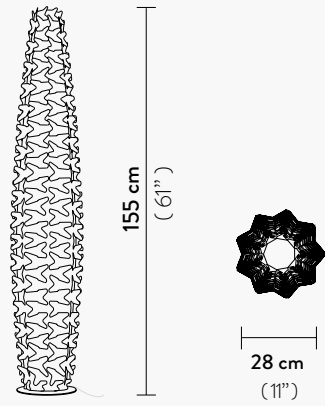

COLOURS:



PRISMA

CACTUS SUSPENSION

1 X12W LED Filament Bulbs E27/E26
MADE OF: Opalflex®

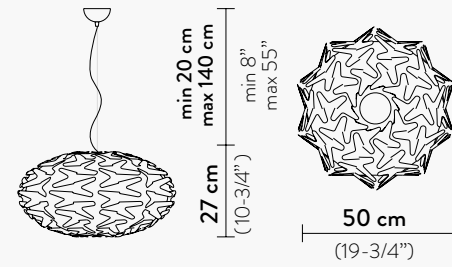

COLOURS:



GOLD

CACTUS FLOOR XXL

2 X12W LED Filament Bulbs E27/E26
MADE OF: Opalflex®
WITH: Stainless Steel base

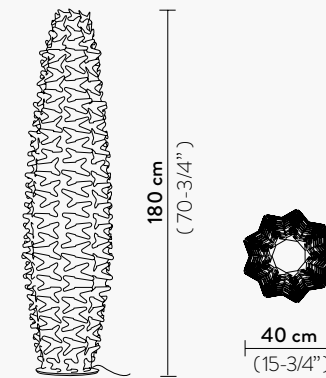

COLOURS:



GOLD

CACTUS FLOOR XL

2 X12W LED Filament Bulbs E27/E26
MADE OF: Opalflex®
WITH: Stainless Steel base

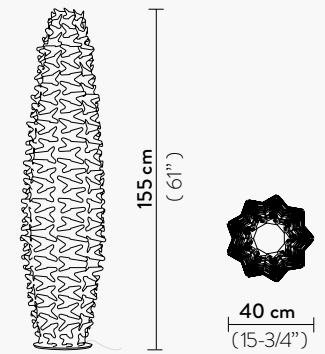

CACTUS PRISMA TABLE XS

1 X 6W LED Filament Bulb E14/E12
MADE OF: Lentiflex®
WITH: Stainless Steel base

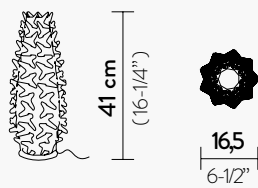

COLOURS:



PRISMA

CACTUS PRISMA TABLE XM

1 X 6W LED Filament Bulb E14/E12
MADE OF: Lentiflex®
WITH: Stainless Steel base

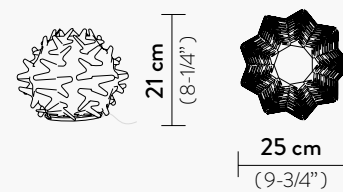

CACTUS TABLE M

1 X 6W LED Filament Bulb E14/E12
MADE OF: Opalflex®
WITH: Stainless Steel base



COLOURS:



GOLD

CACTUS TABLE S

1 X 6W LED Filament Bulb E14/E12
MADE OF: Opalflex®
WITH: Stainless Steel base

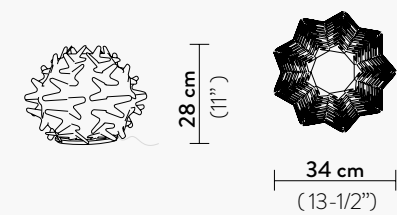

CEREMONY LARGE

4 X 12W LED Filament Bulbs E27/E26
 + 1 X 5W GU10 Spot LED Bulb E27/E26
 MADE OF: Lentiflex® / Cristalflex® / Opalflex®

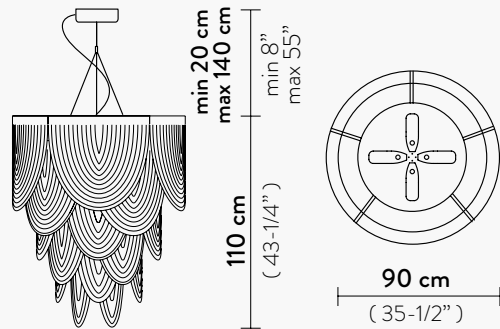

COLOURS:

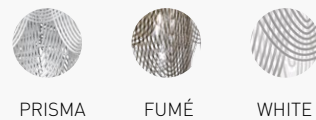

CEREMONY SMALL

3 X 12W LED Filament Bulbs E27/E26
 + 1 X 5W GU10 Spot LED Bulb E27/E26
 MADE OF: Lentiflex® / Cristalflex® / Opalflex®

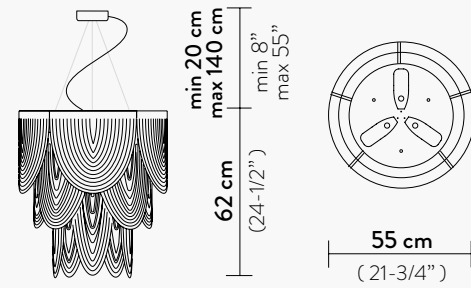

CHARLOTTE GLOBE

4 X 12W LED Filament Bulbs E27/E26
 MADE OF: Cristalflex® / Lentiflex®
 WITH: Magnetic System®

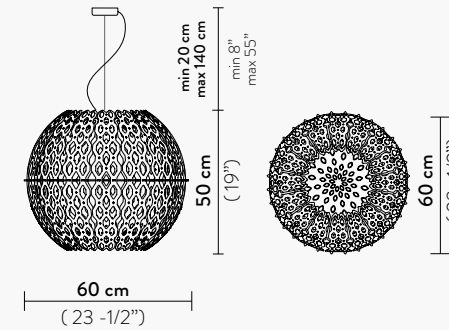

COLOURS:



HALF CHARLOTTE SUSPENSION

LED: 70W - 220V - 7.000 Lumen - 2700 Kelvin - CRI >90
 Triac Dimmable Trailing Edge min. 20W (110V-220V version)
 MADE OF: Cristalflex® / Lentiflex®

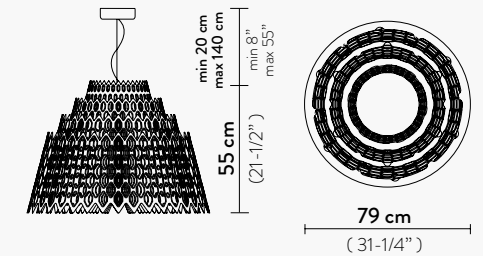

COLOURS:



CHANTAL SUSPENSION M

LED: 70W - 220V - 8.000 Lumen
 2700 Kelvin - CRI 90
 Triac Dimmable Trailing Edge min. 20W (110V-220V version)
 MADE OF: Cristalflex® / Lentiflex®
 WITH: Magnetic System®

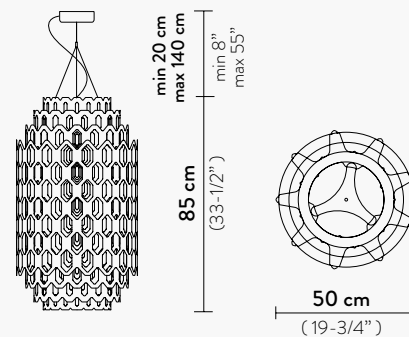

COLOURS:

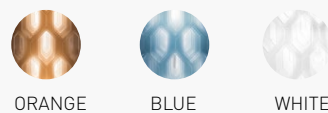

CHANTAL SUSPENSION S

LED: 35W - 220V - 4.000 Lumen
 2700 Kelvin - CRI 90
 Triac Dimmable Trailing Edge min. 20W (110V-220V version)
 MADE OF: Cristalflex® / Lentiflex®
 WITH: Magnetic System®

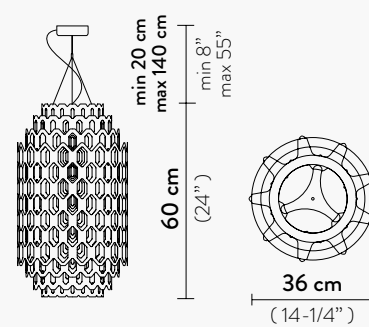

CHARLOTTE WALL LAMP

1 X 12W LED Filament Bulb E27/E26
 MADE OF: Cristalflex® / Lentiflex®

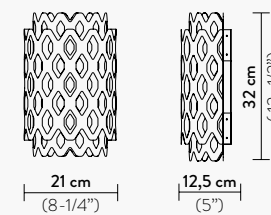

COLOURS:



CHARLOTTE FLOOR

2 X 12W - LED Dimmable Bulbs - E27/E26
 MADE OF: Cristalflex® / Lentiflex®
 WITH: Dimmer

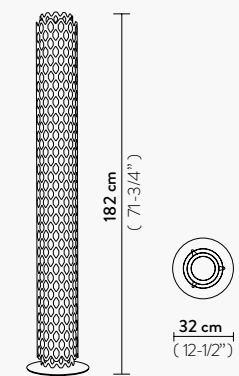

COLOURS:



CLIZIA CEILING-WALL L

3 X 12W LED Filament Bulbs E27/E26
MADE OF: Opalflex® / Cristalflex®
WITH: Magnetic System®

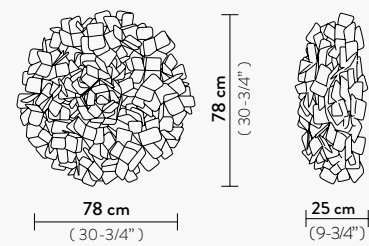

CLIZIA CEILING-WALL M

2 X 12W LED Filament Bulbs E27/E26
MADE OF: Opalflex® / Cristalflex®
WITH: Magnetic System®

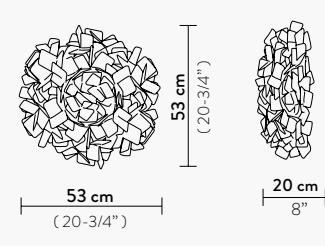

CLIZIA CEILING-WALL MINI

2 X 6W LED Filament Bulbs E14/E12
MADE OF: Opalflex® / Cristalflex®
WITH: Magnetic System®

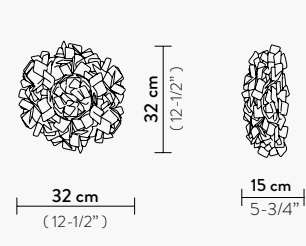

COLOURS:

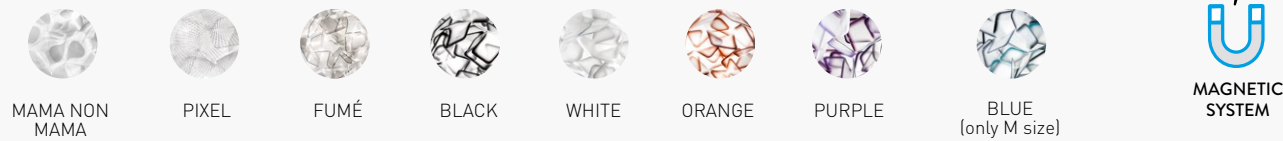

CLIZIA APPLIQUE

2 X 6W LED Filament Bulbs E14/E12
MADE OF: Cristalflex®
WITH: MagneticSystem®

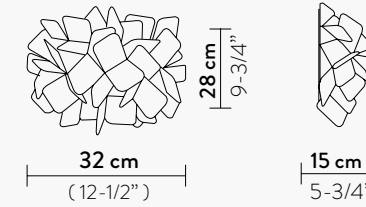

COLOURS:

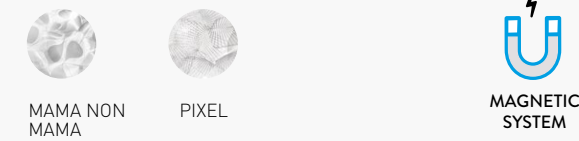

CLIZIA BATTERY

BATTERY LED: 1.8W LED - 350 Lumen
2700 Kelvin - Rechargeable Li-on battery
14 hours operating time - 5 hours recharging time
MADE OF: Lentiflex® / Cristalflex®
WITH: USB / DC plug included
USB Multicharger station (20 ports) upon request

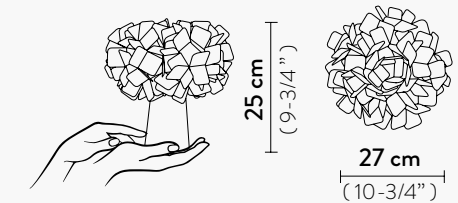

COLOURS:

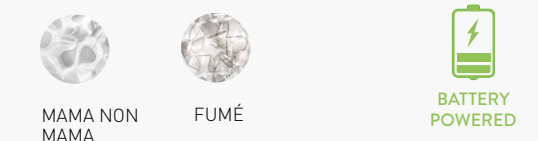

CLIZIA SUSPENSION LARGE

4 X 12W LED Filament Bulbs E27/E26
MADE OF: Lentiflex® / Cristalflex®
WITH: Magnetic System®
Mama non Mama and Pixel with Red wrapped cable,
available also with transparent cable

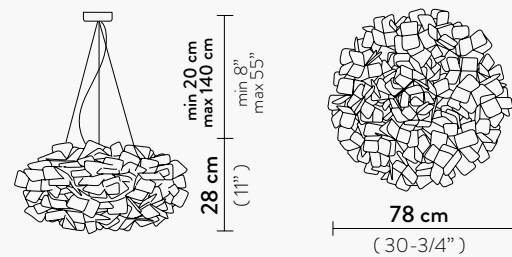

CLIZIA SUSPENSION

2 X 12W LED Filament Bulbs E27/E26
MADE OF: Lentiflex® / Cristalflex®
WITH: Magnetic System®
Mama non Mama and Pixel with Red wrapped cable,
available also with transparent cable

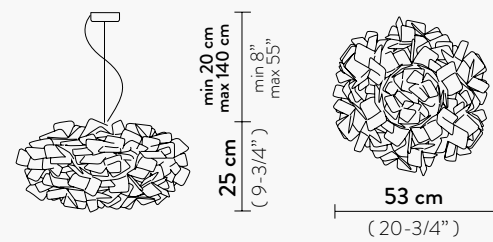

COLOURS:

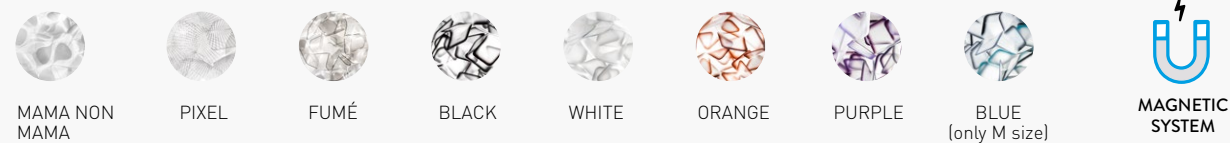

CLIZIA TABLE

1 X 6W LED Filament Bulb E14/E12
MADE OF: Lentiflex® / Cristalflex®
WITH: Magnetic System® - Coloured steel base

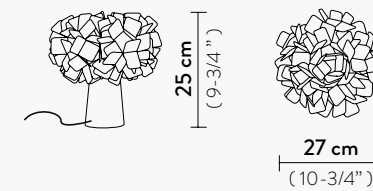

COLOURS:

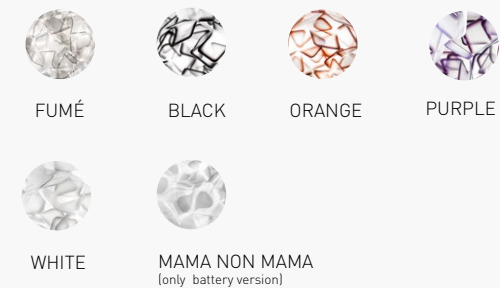

CLIZIA FLOOR

3 X 12W LED Filament Bulbs E27/E26
MADE OF: Opalflex® / Lentiflex® / Cristalflex®
WITH: Magnetic System®

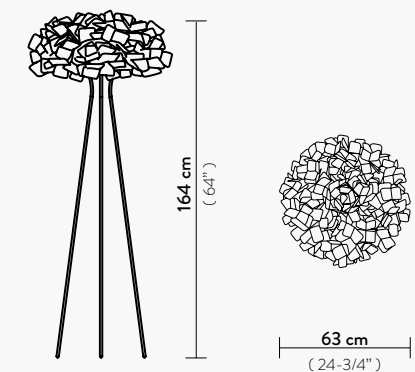

COLOURS:

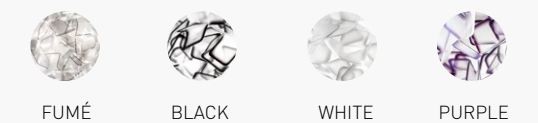

CORDOBA SUSPENSION

LED: 130W X - 110 ~ 220 Vac /24 Vdc
15.000 Lumen 2900 Kelvin - CRI > 90
Dimmable with PWM / 0-10 or Potent.
(110V-220V version)
Additional dimming system Dali, Bluetooth,
Casambi, Triac upon request.
MADE OF: Cristalflex®

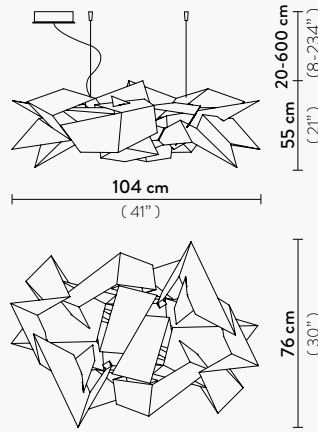

COLOURS:



WHITE

DAFNE FLOOR

3 X 12W LED Filament Bulbs E27/E26
MADE OF: Opalflex®
WITH: Dimmer - Aluminum profiles

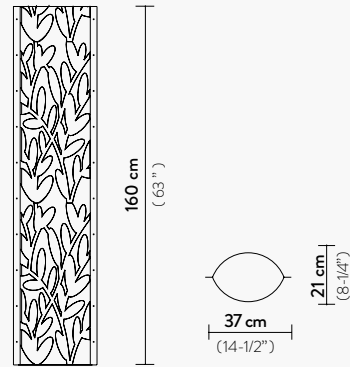

COLOURS:



WHITE

DAFNE TABLE

1 X 6W LED Filament Bulb E14/E12
MADE OF: Opalflex®

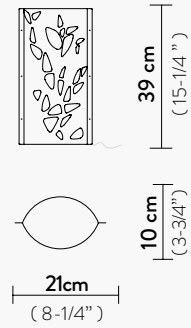

COLOURS:



WHITE

DIAMOND FLOOR L

1 X 12W LED Filament Bulbs E27/E26
MADE OF: Opalflex®
WITH: Aluminium base

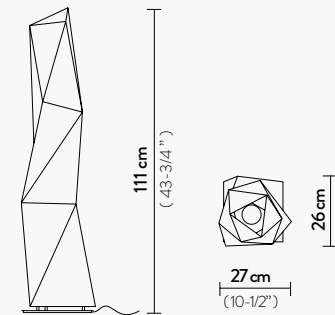

COLOURS:



WHITE

DIAMOND FLOOR M

1 X 12W LED Filament Bulbs E27/E26
MADE OF: Opalflex®
WITH: Aluminium base

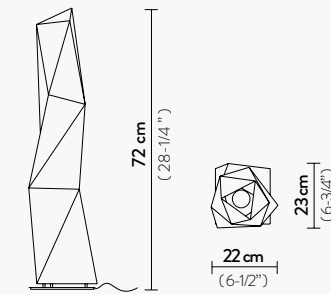

DIAMOND TABLE S

1 X 6W LED Filament Bulb E14/E12
MADE OF: Opalflex®
WITH: Aluminium base

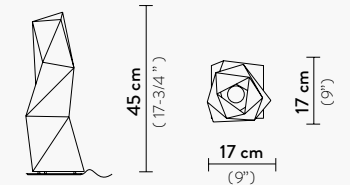

COLOURS:



WHITE

DAFNE CEILING/WALL L

4 X 12W LED Filament Bulbs E27/E26
MADE OF: Opalflex®
WITH: Magnetic System®

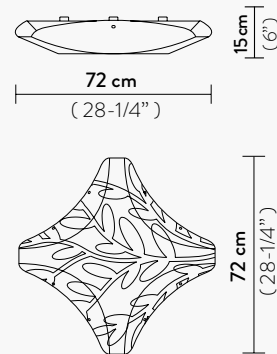

COLOURS:



WHITE

DAFNE CEILING/WALL M

3 X 12W LED Filament Bulbs E27/E26
MADE OF: Opalflex®
WITH: Magnetic System®

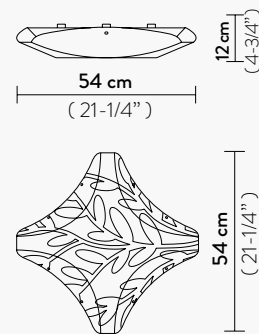

DAFNE CEILING/WALL S

2 X 12W LED Filament Bulbs E27/E26
MADE OF: Opalflex®
WITH: Magnetic System®

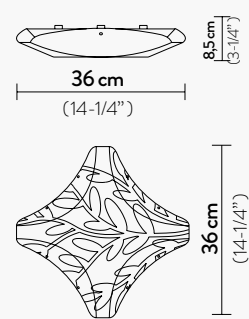

MAGNETIC SYSTEM

DIMPLE SUSPENSION PENTA

5 X 12W LED Filament Bulbs E27/E26
5 X 7W PAR LED (max Ø 60 mm) E27/E26
MADE OF: Cristalflex® / Stainless Steel

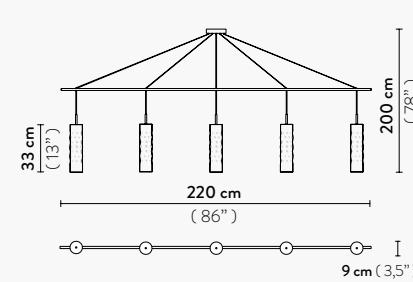

COLOURS:



GOLD



SILVER



COPPER

DIMPLE SUSPENSION TRIO

3 X 12W LED Filament Bulbs E27/E26
3 X 7W PAR LED (max Ø 60 mm) E27/E26
MADE OF: Cristalflex® / Stainless Steel

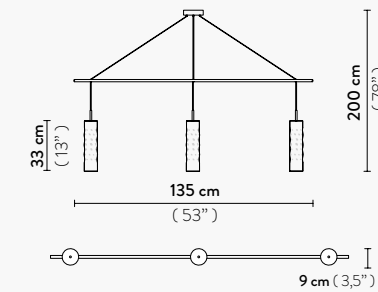

DIMPLE SUSPENSION SINGLE

1 X 12W LED Filament Bulbs E27/E26
1 X 7W PAR LED (max Ø 60 mm) E27/E26
MADE OF: Cristalflex® / Stainless Steel

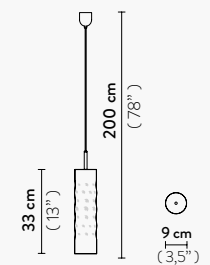

DRUSA SUSPENSION

4 X 12W LED Filament Bulbs E27/E26

MADE OF: Lentiflex®

WITH: Magnetic System®

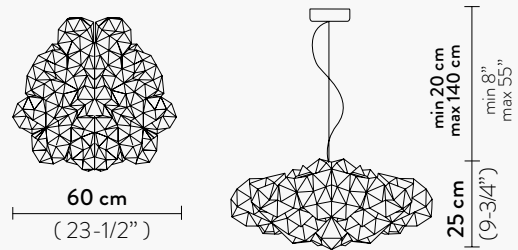

COLOURS:



WHITE



VELVET



MAGNETIC SYSTEM

DRUSA CEILING - WALL

4 X 12W LED Filament Bulbs E27/E26

MADE OF: Lentiflex®

WITH: Magnetic System®

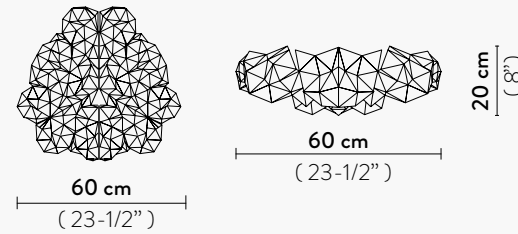

COLOURS:



WHITE



VELVET



MAGNETIC SYSTEM

ÉTOILE LARGE

LED: 21W - 110 ~ 240 Vac /40 Vdc

2.830 Lumen - 2700 Kelvin - CRI 90

220V version dimmable with: PWM / 0-10

110V version dimmable with: Triac

MADE OF: Lentiflex®

WITH: Patented LED Light Source with Magnetic System®

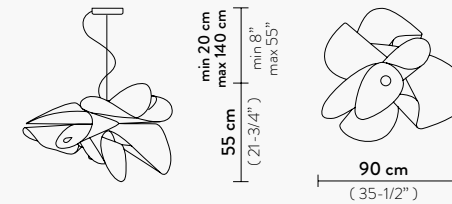

COLOURS:



PRISMA



MAGNETIC CHANGEABLE LED SOURCE

ÉTOILE

LED: 21W - 110 ~ 240 Vac /40 Vdc

2.830 Lumen - 2700 Kelvin - CRI 90

220V version dimmable with: PWM / 0-10

110V version dimmable with: Triac

MADE OF: Lentiflex®

WITH: Patented LED Light Source with Magnetic System®

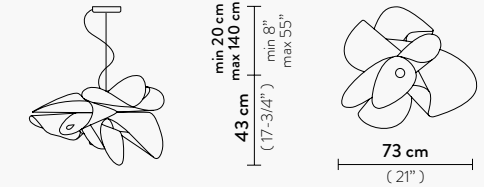

ECSTACITY FLOOR

3 X 12W LED Filament Bulbs E27/E26

MADE OF: Opalflex®

WITH: Dimmer

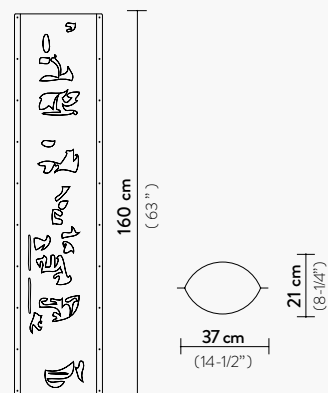

COLOURS:



WHITE

ÉTOILE CEILING / WALL

LED: 15W -200-240Vac / 40 Vdc - 2150 Lumen

2700 Kelvin - CRI 90

Dimmable with Triac (110V-220V)

MADE OF: Lentiflex®

WITH: MagneticSystem®

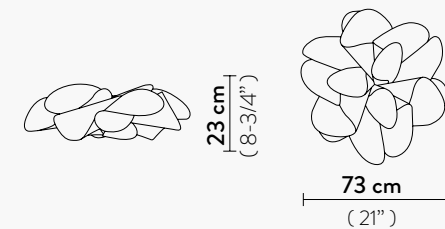

COLOURS:



PRISMA



MAGNETIC SYSTEM

FABULA SUSPENSION LARGE

5 X 12W LED Filament Bulb E27/E26

MADE OF: Lentiflex®

WITH: Magnetic System®

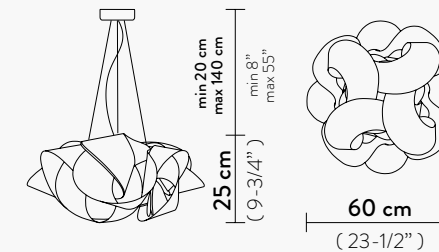

COLOURS:



PRISMA



MAGNETIC SYSTEM

FABULA SUSPENSION

3 X 12W LED Filament Bulb E27/E26

MADE OF: Lentiflex®

WITH: Magnetic System®

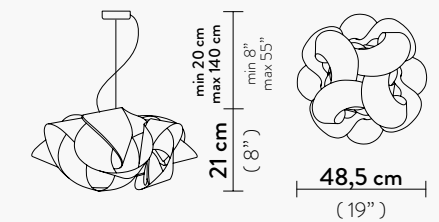

FABULA CEILING/WALL LARGE

5 X 12W LED Filament Bulb E27/E26

MADE OF: Lentiflex®

WITH: Magnetic System®

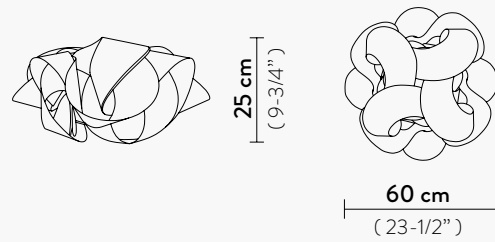

COLOURS:



PRISMA



FABULA CEILING/WALL

3 X 12W LED Filament Bulb E27/E26

MADE OF: Lentiflex®

WITH: Magnetic System®

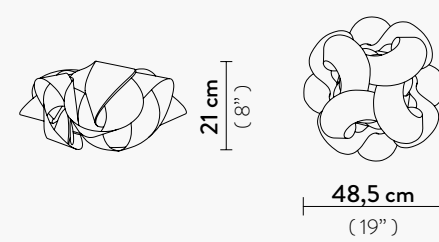

FIGRELLA MINI APPLIQUE

1 X 6W LED Filament Bulbs E14/E12

MADE OF: Opalflex® / Cristalflex®

WITH: Stainless Steel Support

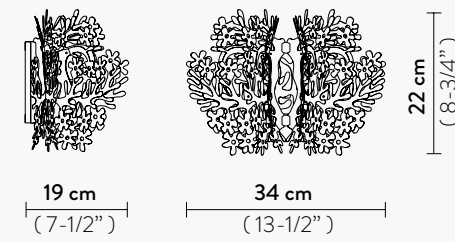

COLOURS:



WHITE



FUMÉ

FIGRELLINA TABLE

1 X 6W LED Filament Bulb E14/E12

MADE OF: Opalflex® / Cristalflex®

Goldflex® / Steelflex®/ Copperflex®

WITH: Base matching colour

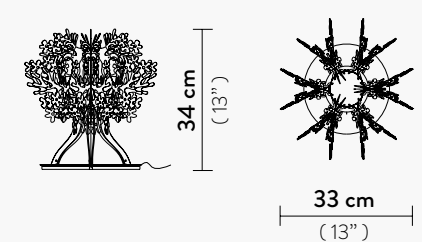

COLOURS:



WHITE



FUMÉ



GOLD



SILVER



COPPER

FIGRELLA SUSPENSION

1 X 12W LED Filament Bulb E27/E26

MADE OF: Opalflex® / Cristalflex®

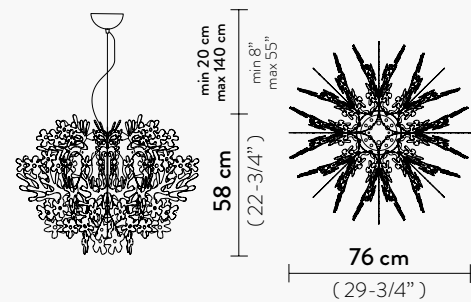

COLOURS:



WHITE



FUMÉ

FIGRELLA SUSPENSION MINI

1 X 12W LED Filament Bulb E27/E26

MADE OF: Opalflex® / Cristalflex® / Goldflex® / Steelflex® / Copperflex®

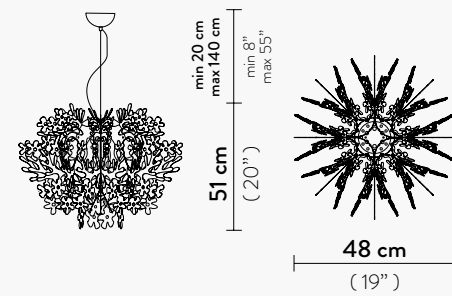

COLOURS:



WHITE



GOLD



SILVER



COPPER

FIGRELLA FLOOR

1 X 12W LED Filament Bulb E27/E26

MADE OF: Opalflex® / Cristalflex®

WITH: Stainless Steel base

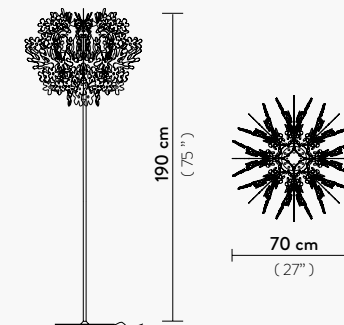

COLOURS:



WHITE



FUMÉ

FLORA FLOOR

3 X 12W LED Filament Bulbs E27/E26

MADE OF: Lentiflex® - Methacrylate

Goldflex® / Steelflex®/ Copperflex® / Pewterflex®

WITH: Magnetic System® - Hand finished Sphere - Dimmer

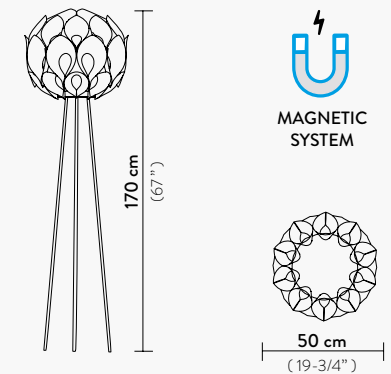

COLOURS:



WHITE



GOLD



SILVER



COPPER



PEWTER

FLORA SUSPENSION M

3 X12W LED Filament Bulbs E27/E26
MADE OF: Lentiflex® - Methacrylate
Goldflex® / Steelflex® / Copperflex® /
Pewterflex®

WITH: Magnetic System®
Hand - finished Sphere

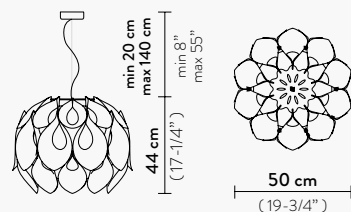

COLOURS:

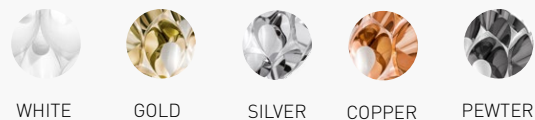

FLORA SUSPENSION S

1 X12W LED Filament Bulbs E27/E26
MADE OF: Lentiflex® - Methacrylate
Goldflex® / Steelflex® / Copperflex® /
Pewterflex®

WITH: Magnetic System®
Hand - finished Sphere

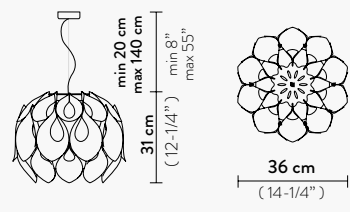

COLOURS:

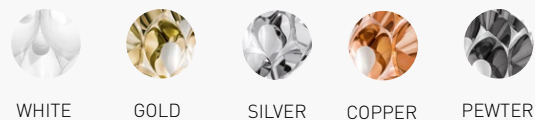

GEMMY PRISMA FLOOR

1 X12W LED Filament Bulb E27/E26
MADE OF: Lentiflex®

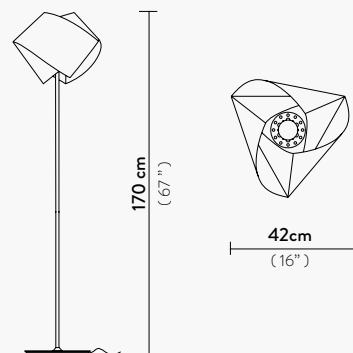

COLOURS:

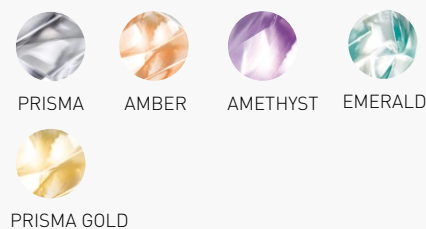

GINETTA SUSPENSION

1 X 12W LED Filament Bulb E27/E26
MADE OF: Opalflex® / Cristalflex® / Steelflex® / Lentiflex®
WITH: Iridescent bulb screen and
Magnetic System® (Prisma version)

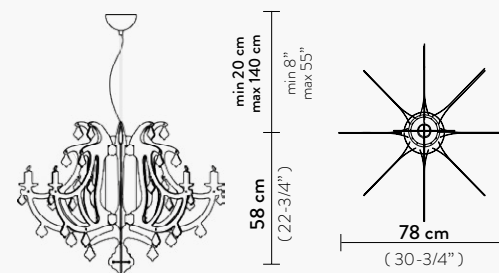

COLOURS:

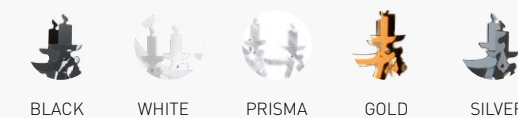

GOCCIA SUSPENSION

1 X 12W LED Filament Bulb E27/E26
MADE OF: Opalflex® / Lentiflex®

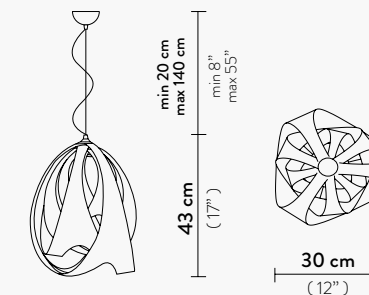

COLOURS:

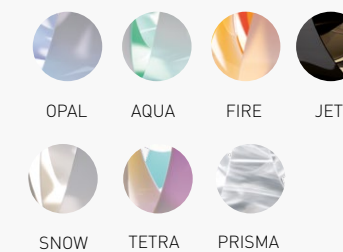

GEMMY SUSPENSION

1 X 12W LED Filament Bulb E27/E26
MADE OF: Opalflex® or Lentiflex®

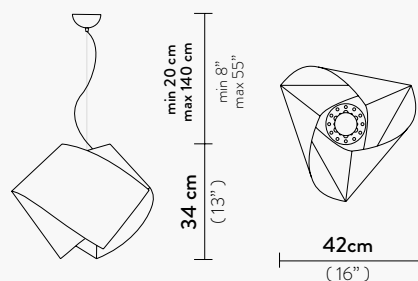

COLOURS:

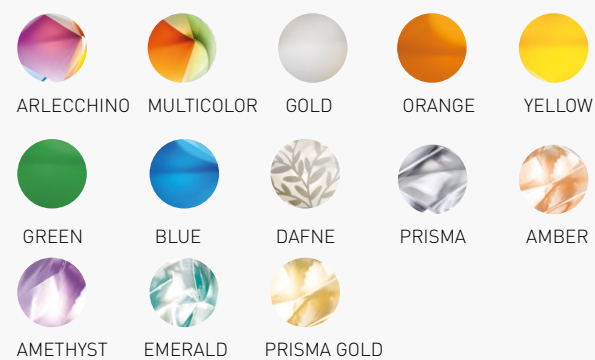

GEMMY TABLE

1 X 6W LED Filament Bulb E14/E12
MADE OF: Opalflex® or Lentiflex®

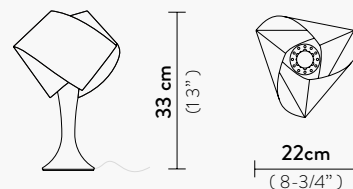

COLOURS:

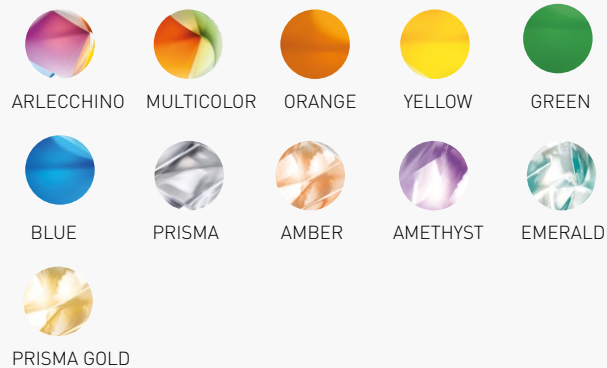

HANAMI SUSPENSION L

10 X 5W LED Dimmable Bulbs G9

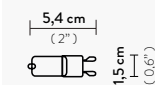

MADE OF: Lentiflex® / Polycarbonate
Stainless Steel

WITH: Red wrapped electric wire
Available also with transparent cable

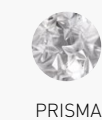
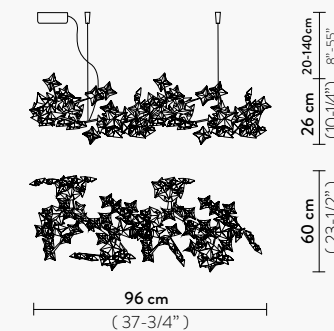

HANAMI SUSPENSION

5 X 5W LED Dimmable Bulbs G9

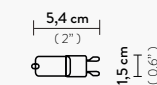

MADE OF: Lentiflex® / Polycarbonate
Stainless Steel

WITH: Red wrapped electric wire
Available also with transparent cable

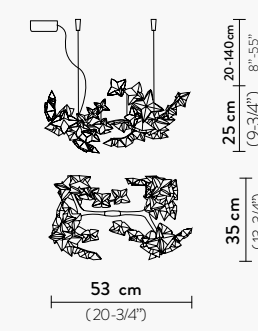

HANAMI CEILING/WALL

7 X 5W LED Dimmable Bulbs G9

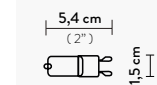

MADE OF: Lentiflex® / Polycarbonate /
Stainless Steel

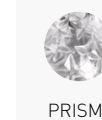
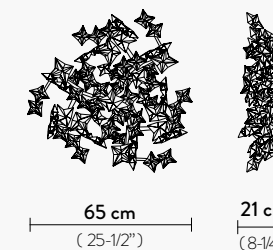

HUGO ARCHITECTURAL SYSTEM

COMPONENTS:

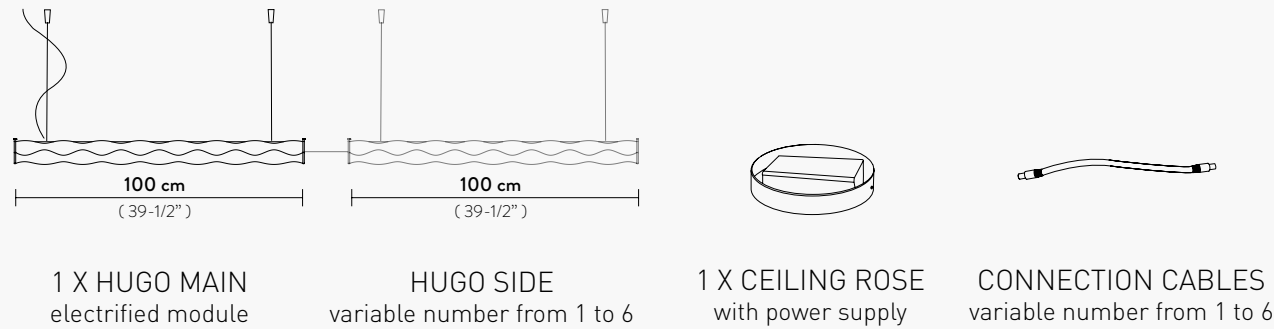

ARCHITECTURAL SYSTEM 2

40W - 100-240V / 24Vdc
7000 Lumen - 3000 Kelvin
Dimmable with: PWM, 0-10 (110V-220V)
Additional dimming system Dali, Bluetooth, Casambi, Triac upon request

ARCHITECTURAL SYSTEM 5

100W - 100-240V / 24Vdc
17.500 Lumen - 3000 Kelvin
Dimmable with: PWM, 0-10 or Potentiometer (110V-220V)
Additional dimming system Dali, Bluetooth, Casambi, Triac upon request

ARCHITECTURAL SYSTEM 3

60W - 100-240V / 24Vdc
10.500 Lumen - 3000 Kelvin
Dimmable with: PWM, 0-10 or Potentiometer (110V-220V)
Additional dimming system Dali, Bluetooth, Casambi, Triac upon request

ARCHITECTURAL SYSTEM 6

120W - 100-240V / 24Vdc
21.000 Lumen - 3000 Kelvin
Dimmable with: PWM, 1-10 or Potentiometer (110V-220V)
Additional dimming system Dali, Bluetooth, Casambi, Triac upon request

ARCHITECTURAL SYSTEM 4

80W - 100-240V / 24Vdc
14.000 Lumen - 3000 Kelvin
Dimmable with: PWM, 0-10 or Potentiometer (110V-220V)
Additional dimming system Dali, Bluetooth, Casambi, Triac upon request

ARCHITECTURAL SYSTEM 7

140W - 100-240V / 24Vdc
24.500 Lumen - 3000 Kelvin
Dimmable with: PWM, 1-10 or Potentiometer (110V-220V)
Additional dimming system Dali, Bluetooth, Casambi, Triac upon request

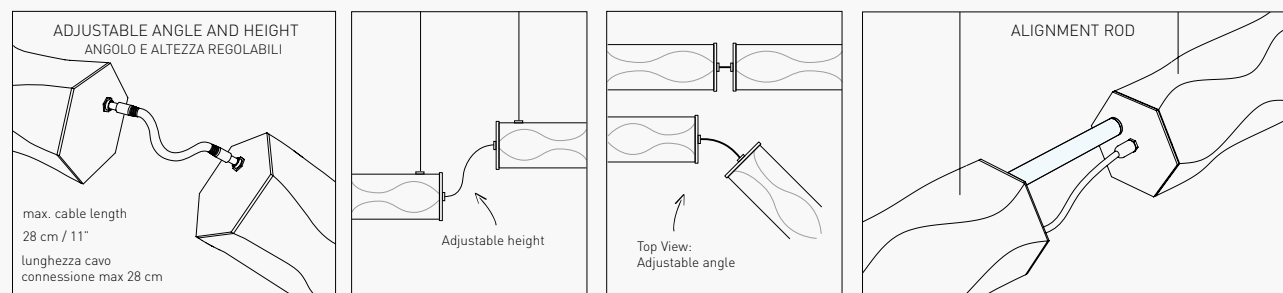

Plexiglass magnetic alignment rod to perfectly align modules are available upon request
Disponibile su richiesta una barretta di plexiglas trasparente con estremità magnetiche per tenere i moduli perfettamente allineati.

COLOURS:

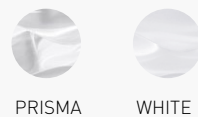

PRISMA WHITE

HUGO SUSPENSION

LED: 25W X - 100 ~ 240 Vac / 24 Vdc - 3.500 Lumen
3000 Kelvin (4.000 upon request) - CRI >90
Dimmable with : PWM / 0-10 (110V-220V)
Dali, Bluetooth, Casambi, Triac upon request
MADE OF: Lentiflex®

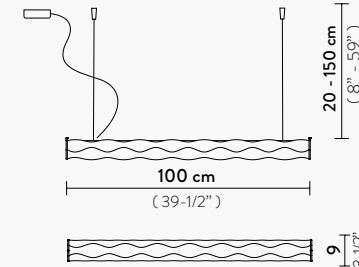

COLOURS:



PRISMA WHITE

HUGO FLOOR

LED: 40W -100~240Vac/24Vdc - 7.000 lumen - 3000 Kelvin
Dimmable
MADE OF: Lentiflex® - Stainless steel
With: Integrated Dimmer

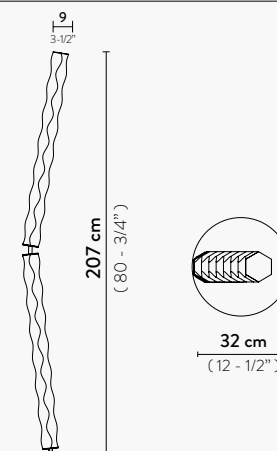

COLOURS:



PRISMA

HUGO VERTICAL

LED: 25W X - 100 ~ 240 Vac / 24 Vdc - 3.500 Lumen
3000 Kelvin (4.000 upon request) - CRI >90
Dimmable with : PWM / 0-10 (110V-220V)
Dali, Bluetooth, Casambi, Triac upon request
MADE OF: Lentiflex®

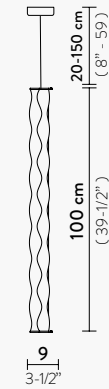

COLOURS:



PRISMA WHITE

IDEA TABLE LAMP

1 X 5W G9 LED
MADE OF: Technopolymer / Brushed Brass

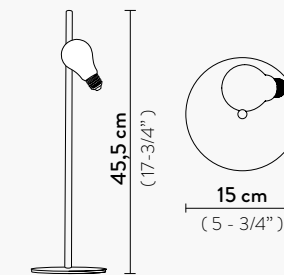
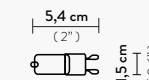

COLOURS:



BRASS

IDEA APPLIQUE

1 X 5W G9 LED Dimmable
MADE OF: Technopolymer / Stainless Steel
or White coated Steel

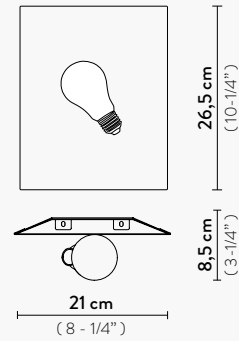
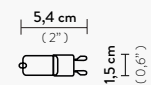

COLOURS:

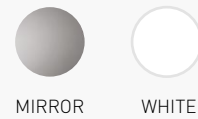

IDEA RECESSED WALL LAMP

1 X 5W G9 LED Dimmable
MADE OF: Technopolymer /Plaster

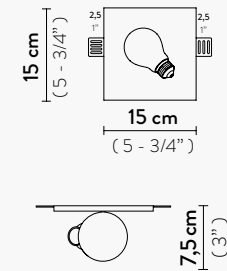
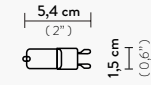

KALATOS CEILING/WALL

4 X 12W LED Filament Bulbs E27/E26
MADE OF: Lentiflex® / Polycarbonate
or Metallized Polycarbonate

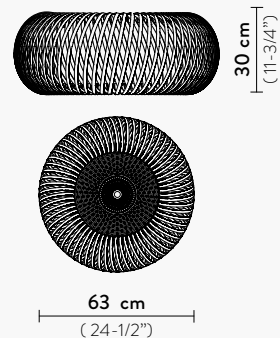

COLOURS:

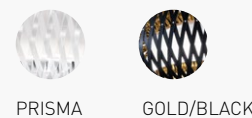

KALATOS SUSPENSION

4 X 12W LED Filament Bulbs E27/E26
MADE OF: Lentiflex® / Polycarbonate
or Metallized Polycarbonate

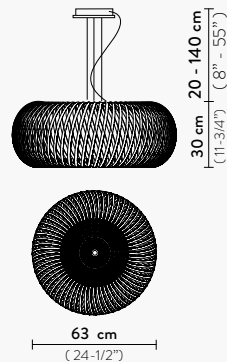

COLOURS:

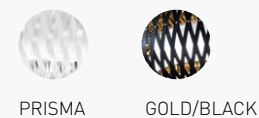

LA BELLE ÉTOILE LARGE

LED: 21W - 110~240 Vac /40 Vdc
2.830 Lumen - 2700 Kelvin - CRI 90
220V version dimmable with: PWM / 0-10
110V version dimmable with: Triac

Additional dimming system Dali,
Bluetooth, Casambi, Triac upon request
MADE OF: Cristalflex®
WITH: Patented LED Light Source
with Magnetic System®

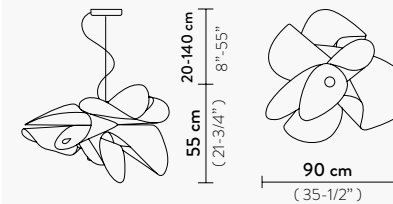

COLOURS:



LA BELLE ÉTOILE

LED: 21W - 110~ 240 Vac /40 Vdc
2.830 Lumen - 2700 Kelvin - CRI 90
220V version dimmable with: PWM / 0-10
110V version dimmable with: Triac

Additional dimming system Dali,
Bluetooth, Casambi, Triac upon request
MADE OF: Cristalflex®
WITH: Patented LED Light Source
with Magnetic System®

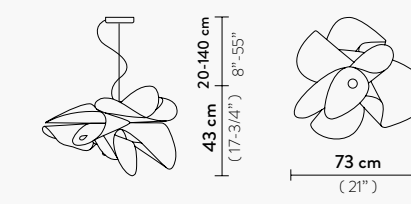

COLOURS:



MAGNETIC SYSTEM

LA BELLE ÉTOILE CEILING / WALL

LED: 15W - 200~240Vac / 40 Vdc
2.150 Lumen - 2700 Kelvin - CRI 90
Dimmable with Triac (220V-110V)

MADE OF: Cristalflex®
WITH: MagneticSystem®

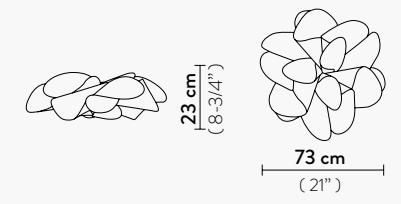

COLOURS:



COLOURS:



MAGNETIC SYSTEM

LA LOLLO XL

LED: 130W - 220~240Vac/ 24Vdc
15.000 Lumen - 2700 Kelvin - CRI >90
220V version dimmable with: PWM / 0-10 or
Potentiometer

110V version dimmable with: Triac
Additional dimming system Dali, Bluetooth,
Casambi, Triac upon request

MADE OF: Cristalflex® / Lentiflex® /
Opalflex® Brushed Goldflex® or Pewterflex®

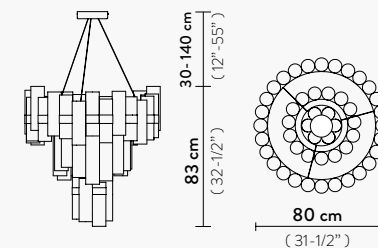

COLOURS:

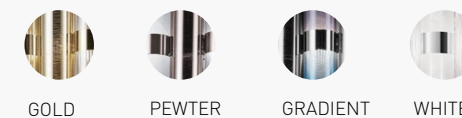

LA LOLLO L

LED: 80W - 220~240Vac/ 24Vdc
9.000 Lumen - 2700 Kelvin - CRI >90
220V version dimmable with: PWM / 0-10 or
Potentiometer

110V version dimmable with: Triac
Additional dimming system Dali, Bluetooth,
Casambi, Triac upon request

MADE OF: Cristalflex® / Lentiflex® /
Opalflex® Brushed Goldflex® or Pewterflex®

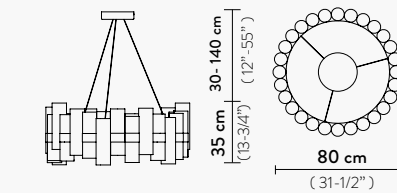

COLOURS:

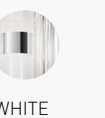

LA LOLLO M

LED: 40W - 220~240Vac/ 24Vdc
4.600 Lumen - 2700 Kelvin - CRI >90
220V version dimmable with: PWM / 0-10 or
Potentiometer

110V version dimmable with: Triac
Additional dimming system Dali, Bluetooth,
Casambi, Triac upon request

MADE OF: Cristalflex® / Lentiflex® /
Opalflex® Brushed Goldflex® or Pewterflex®

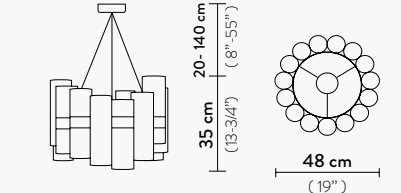

COLOURS:



LA LOLLONA 5

LED: 390 W - 100-240Vac / 24Vdc
44.555 Lumen - 2700 Kelvin - CRI >90
Dimmable with PWM / 0-10 or Potentiometer (110V-220V)

Additional dimming system Dali, Casambi upon request

MADE OF: Cristalflex® / Lentiflex® / Opalflex® Brushed Goldflex® or Pewterflex®

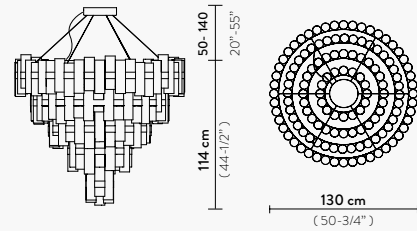

COLOURS:

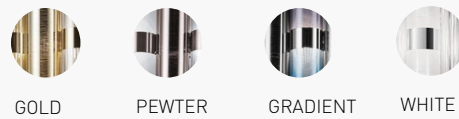

LA LOLLONA 4

LED: 242 W - 100-240Vac / 24Vdc
28.140 Lumen - 2700 Kelvin - CRI >90
Dimmable with PWM / 0-10 or Potentiometer (110V-220V)

Additional dimming system Dali, Casambi upon request

MADE OF: Cristalflex® / Lentiflex® / Opalflex® Brushed Goldflex® or Pewterflex®

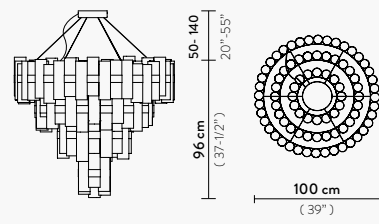

LA LOLLO APPLIQUE

2 X 6W LED Filament Bulbs E14/E12
MADE OF: Cristalflex® / Lentiflex® / Opalflex® Brushed Goldflex® or Pewterflex®

WITH: Stainless Steel Support

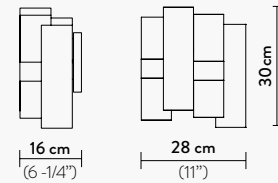

COLOURS:

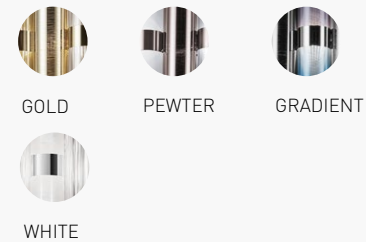

LA VIE CEILING/WALL

2 X 12W LED Filament Bulbs E27/E26
Made of: Lentiflex® / Opalflex®
With: Magnetic System

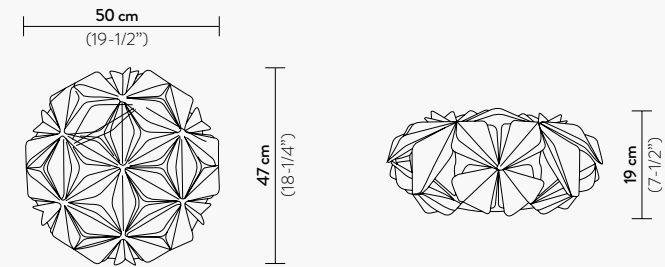

COLOURS:

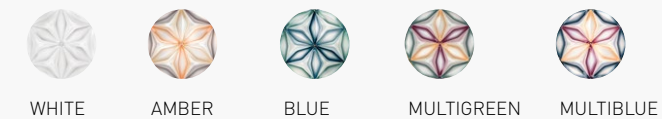

LAFLEUR BATTERY

1,3 W Dimmable LED - 150 Lumen, 2700 K Rechargeable Li-po Battery 5V
Battery duration: at max intensity around 6,5 hours, at minimum around 60 hours.

WITH: USB / DC Plug Included

Magnetic Base and Complementary Steel Anchor

MADE OF: Lentiflex® / Copper Wires
USB Multicharger station (20 ports) upon request

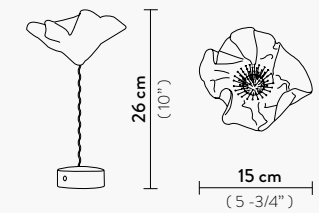

COLOURS:



LA LOLLO FLOOR

3 X 12W LED Dimmable Filament Bulbs E27/E26

MADE OF: Cristalflex® / Lentiflex® / Steelflex®

WITH: Stainless Steel Base - Dimmer

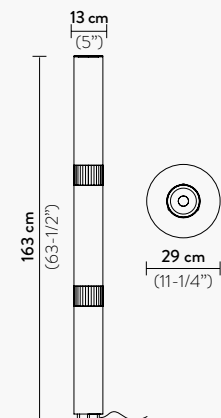

COLOURS:



LA TRAVIATA 220

13 individually dimmable RGB + 1 White LED Main Light

MAIN LED: 100W - 100-240V

7500 Lumen - 2700 Kelvin

WITH: Remote Control or DMX

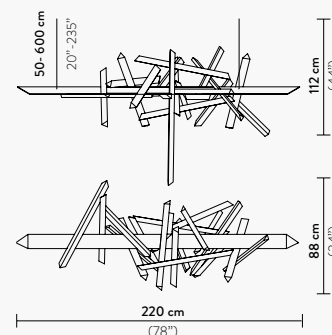

COLOURS:



LA TRAVIATA 180

9 individually dimmable RGB + 1 White LED Main Light

MAIN LED: 100W - 100-240V

6000 Lumen - 2700 Kelvin

WITH: Remote Control or DMX

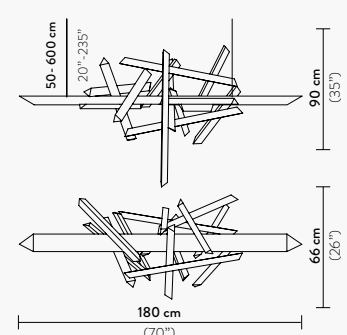

LAS PALMAS FLOOR XL

3 X 12W LED Filament Bulbs E27/E26

MADE OF: Opalflex® / Polycarbonate

WITH: Stainless Steel Base and profiles

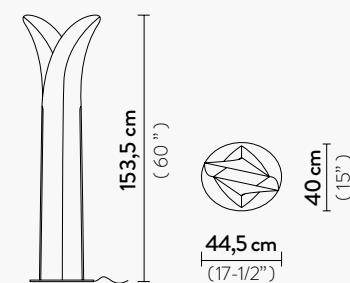

COLOURS:

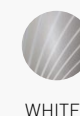

LAS PALMAS FLOOR L

2 X 12W LED Filament Bulbs E27/E26

MADE OF: Opalflex® / Polycarbonate

WITH: Stainless Steel Base and profiles

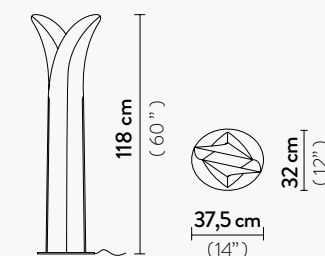

LAS PALMAS TABLE S

1 X 6W LED Filament Bulb E14/E12

MADE OF: Opalflex® / Polycarbonate

WITH: Stainless Steel Base and profiles

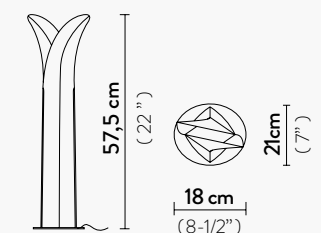

COLOURS:

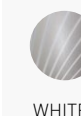

LILLIBET

1 X 12W LED Filament Bulb E27/E26
 MADE OF: Opalflex® / Cristalflex®
 Steelflex®/ Goldflex®/ Copperflex®
 WITH: 56 Schöler® Crystals

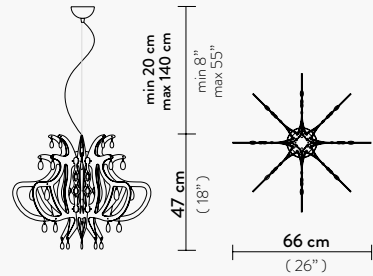

COLOURS:

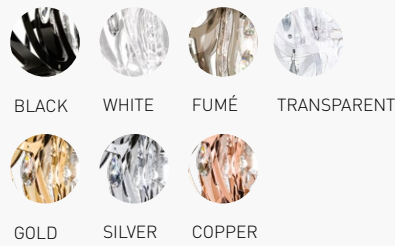

LILLIBET MINI

1 X 6W LED Filament Bulb E14/E12
 MADE OF: Opalflex® / Cristalflex®
 WITH: 42 Schöler® Crystals

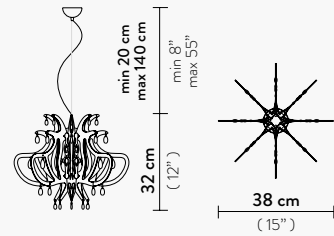

COLOURS:

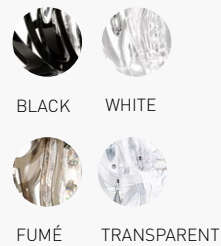

LILLIBET MINI WALL

1 X 6W LED Filament Bulb E14/E12
 MADE OF: Opalflex® / Cristalflex®
 WITH: 26 Schöler® Crystals

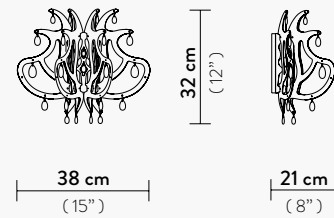

COLOURS:

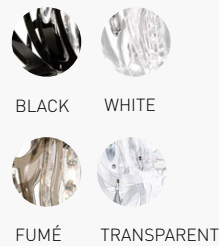

LUIS SUSPENSION

1 X 12W LED Filament Bulb E27/E26
 MADE OF: Lentiflex® / Opalflex®

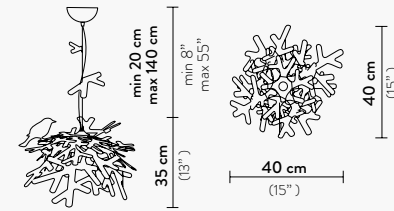

COLOURS:

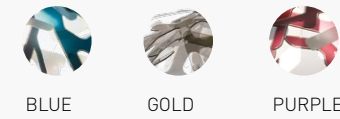

MEDUSA SUSPENSION

1 X 12W LED Filament Bulbs E27/E26
 MADE OF: Opalflex® / Cristalflex®
 Pewterflex®
 WITH: 56 Crystals

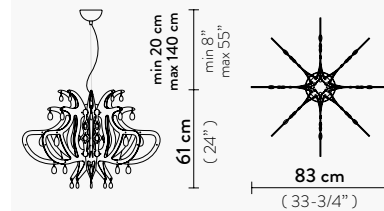

COLOURS:

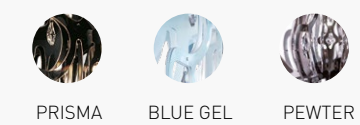

MEDUSA APPLIQUE

1 X 12W LED Filament Bulb E27/E26
 MADE OF: Opalflex® / Cristalflex®
 Pewterflex®
 WITH: 26 Crystals

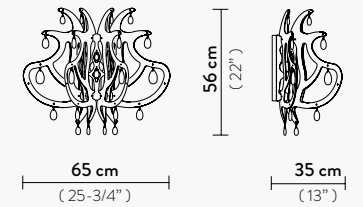

COLOURS:

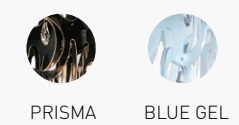

LIZA TABLE

1 X 12W LED Filament Bulbs E27/E26
 BASE LED: 1,5W - 220V - 100 Lumen
 2700 Kelvin
 MADE OF: Lentiflex® or Pewterflex®
 and Polycarbonate
 WITH: 2 Positions light switch
 Courtesy base LED

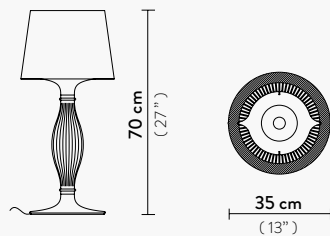

COLOURS:

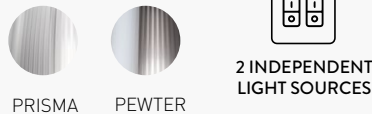

LIZA FLOOR

1 X 12W LED Filament Bulb E27/E26
 MADE OF: Lentiflex® / Polycarbonate

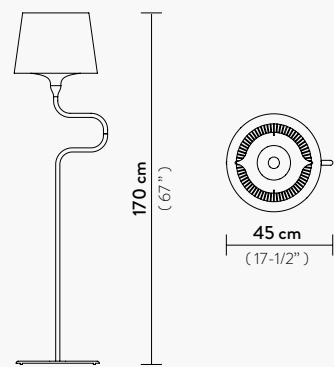

COLOURS:

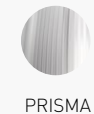

LIZA SUSPENSION

1 X 12W LED Filament Bulbs E27/E26
 MADE OF: Lentiflex®

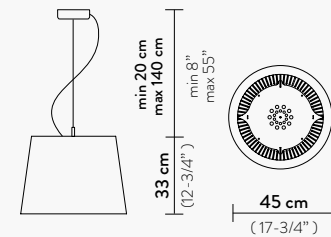

COLOURS:

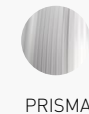

MIDA CEILING-WALL L

4 X 12W LED Filament Bulbs E27/E26
 MADE OF: Opalflex® / Lentiflex® /
 Steelflex® Copperflex®/Brushed
 Goldflex®
 WITH: Magnetic System®

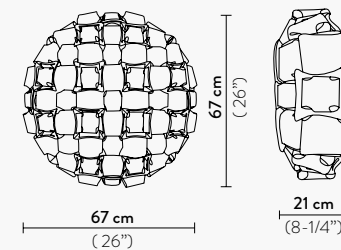

COLOURS:

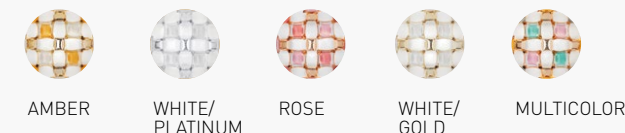

MIDA CEILING-WALL M

3 X 12W LED Filament Bulbs E27/E26
 MADE OF: Opalflex® / Lentiflex® /
 Steelflex® Copperflex®/Brushed
 Goldflex®
 WITH: Magnetic System®

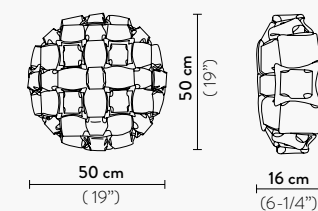

MIDA APPLIQUE

2 X 5W LED Filament Bulbs E14/E12
 MADE OF: Opalflex® / Lentiflex® /
 Steelflex® Copperflex®/Brushed
 Goldflex®
 WITH: Magnetic System®

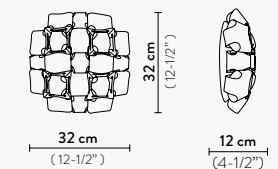

COLOURS:

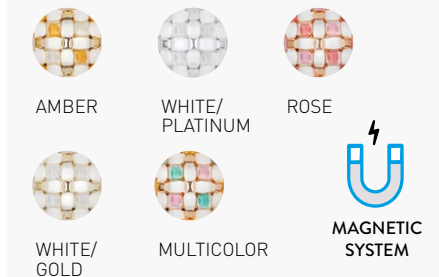

MILLE BOLLE SUSPENSION

1 X 6W LED Bulb G9
 MADE OF: Iridescent Polycarbonate
 WITH: Stainless Steel Structure

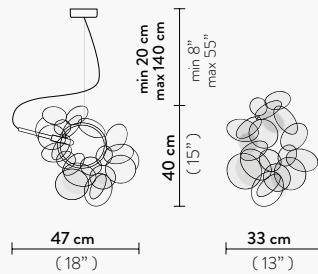

COLOURS:



IRIDESCENT

MILLE BOLLE APPLIQUE

1 X 2W LED Bulb G4
 MADE OF: Iridescent Polycarbonate
 WITH: Stainless Steel Structure

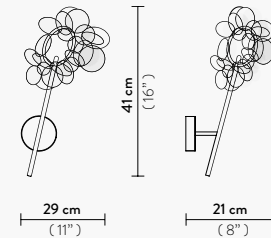

COLOURS:



IRIDESCENT

MILLE BOLLE FLOOR

1 X 6W LED G9 Bulb
 MADE OF: Iridescent Polycarbonate
 WITH: Stainless Steel Structure - base and Dimmer

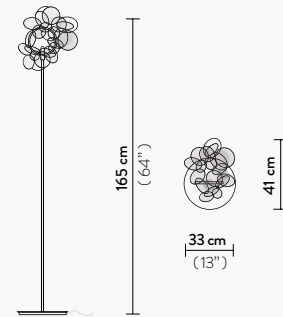

COLOURS:



IRIDESCENT

MILLE BOLLE TABLE

1 X 2W LED Bulb G4
 MADE OF: Iridescent Polycarbonate
 WITH: Stainless Steel Structure

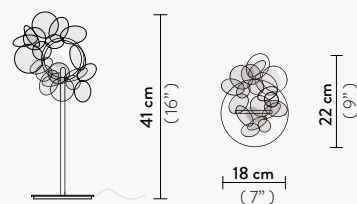

COLOURS:



IRIDESCENT

MIRAGE WALL

LED: 14W - 220 Vac / 12Vdc
 1100 Lumen - 2700 Kelvin
 MADE OF: Lentiflex®
 WITH: Stainless Steel Support

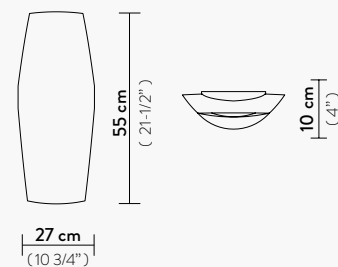

COLOURS:



PRISMA

MOON TABLE

1 X 12W LED Filament Bulbs E27/E26
 MADE OF: Opalflex®
 WITH: Aluminium profiles brass finish, Digital Marble Texture

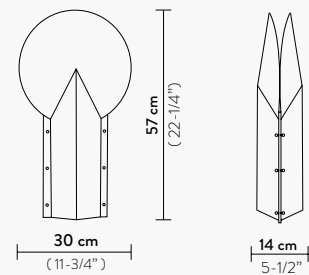

COLOURS:

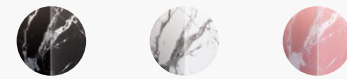

BLACK

WHITE

PINK

NUVEM MODULAR

2 X 8W LED GU10
 Bidirectional Spot Light
 MADE OF: Opalflex®

>> Modules of 1 sq. meter can be joined in infinite combinations;

>> Moduli da 1 mq componibili all'infinito.

>> Available additional modules without spotlight

>> Disponibili moduli aggiuntivi senza spotlight

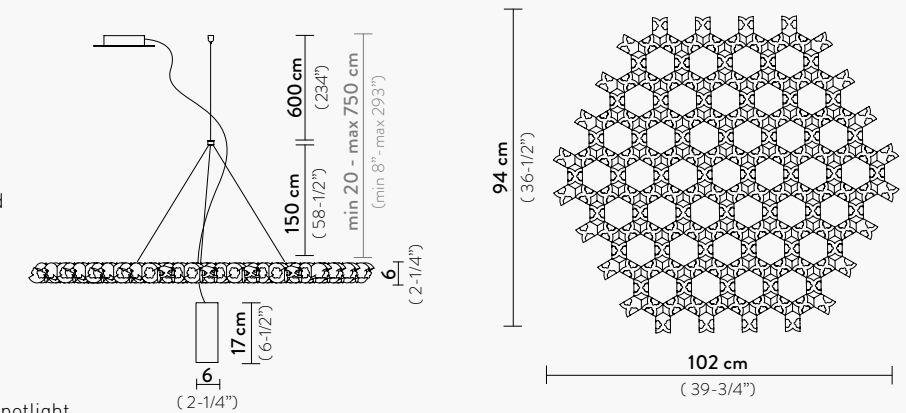

ADDITIONAL SUSPENSION SPOTLIGHT

2 X 8W LED GU10 - Bidirectional Spot Light
 MADE OF: Steel - white RAL 9016

WHIT: 6 m electric wires
 6 m steel cable

>> GU10 bulbs on request

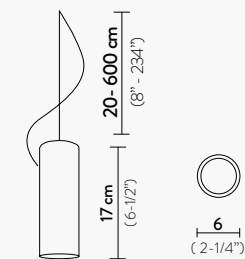

WIRE CEILING ANCHOR INCLUDED

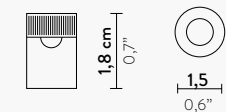

ADDITIONAL CEILING/WALL SPOTLIGHT

1 X 8W LED GU10 - Unidirectional Spot Light
 MADE OF: Steel - white RAL 9016

>> GU10 bulb on request

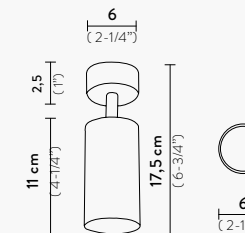

NUVEM CANOPY

Canopy max 6 electric wires
 Coppetta con alloggiamento di max 6 cavi
 MADE OF: Steel - white RAL 9016

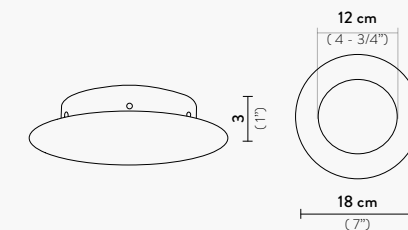

THE CANOPY FITS FROM 1 TO 6 MODULES

MODULE COLOUR:



WHITE

SPOTLIGHT AND CANOPY:



WHITE - RAL 9016

OVERLAY TABLE

Shade LED: 4W - 24Vdc - 500 Lumen - 2700 Kelvin - CRI >90

Base LED: 1,5W - 24Vdc - 90 Lumen - 2700 Kelvin - CRI >90

Made of: Brass, Brushed Copperflex® and Lentiflex®

WITH: LED courtesy light in the base, independent from the principle light source and Montblanc Meisterstück LeGrand writing instrument

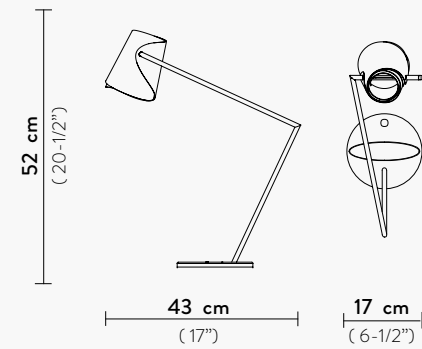

AVAILABLE WITH MONTBLANC WRITING INSTRUMENT

1 - Meisterstück LeGrand Fountain Pen Gold-Coated

2 - Meisterstück LeGrand Ballpoint Pen Gold-Coated



COLOURS:



BRASS



2 INDEPENDENT LIGHT SOURCES

SUPERMORGANA

1 X 5W LED Bulb G9

MADE OF: Metallized Polycarbonate

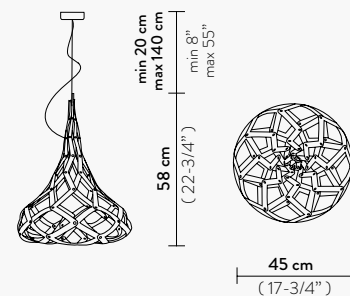

COLOURS:



GOLD/BLACK



MIRROR/BLACK

THE LIGHTNING ARCHIVES FLOOR

3 X 12W LED Filament Dimmable Bulbs E27/E26

MADE OF: Cristalflex® / Opalflex®

WITH: Dimmer - Brass or Coloured finish profiles

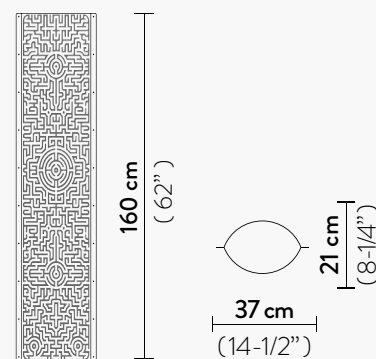

COLOURS:



FAENA



L'AFRIQUE



BANANAS



LABYRINTH



PEACE SKULL



PERISHED



LOVE PEACE JOY

VELI SUSPENSION L

4 X 12W LED Filament Bulbs E27/E26

MADE OF: Opalflex® / Lentiflex®

Steelflex® / Goldflex® / Copperflex®

WITH: Magnetic System®

Couture with Red wrapped cable, available also with transparent cable

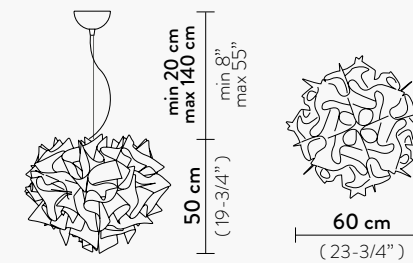

COUTURE VERSION CEILING ROSE

COLOURS:



COUTURE



GOLD



SILVER



COPPER



PRISMA



PLUM



OPAL



CHARCOAL



MAGNETIC SYSTEM

VELI SUSPENSION

2 X 12W LED Filament Bulbs E27/E26

MADE OF: Opalflex® / Lentiflex®

Steelflex® / Goldflex® / Copperflex®

WITH: Magnetic System®

Couture with Red wrapped cable, available also with transparent cable

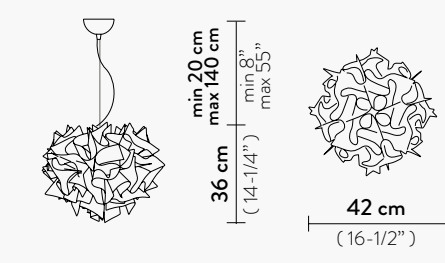

COUTURE VERSION CEILING ROSE

VELI MINI SINGLE

1X 12W LED Filament Bulb E27/E26

MADE OF: Opalflex®

WITH: Magnetic System®

Red wrapped cable, available also with transparent cable

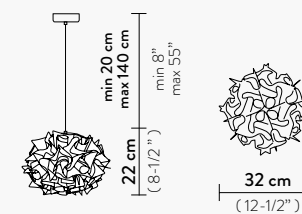

COLOURS:



COUTURE



MAGNETIC SYSTEM

VELI MINI TRIO

3 X 12W LED Filament Bulbs E27/E26

MADE OF: Opalflex®

WITH: Magnetic System®

Red wrapped cable, available also with transparent cable

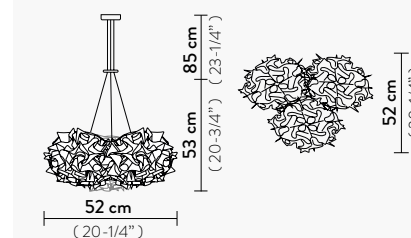

COLOURS:



COUTURE



MAGNETIC SYSTEM

VELI MINI QUARTET

4 X 12W LED Filament Bulbs E27/E26

MADE OF: Opalflex®

WITH: Magnetic System®

Red wrapped cable, available also with transparent cable

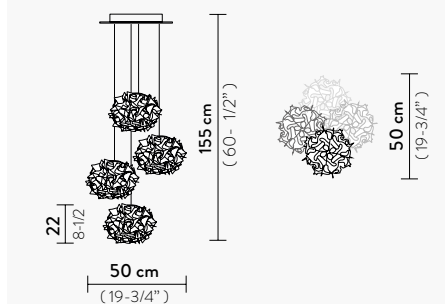

COLOURS:



COUTURE



MAGNETIC SYSTEM

VELI CEILING-WALL L

3 X 12W LED Filament Bulbs E27/E26
 MADE OF: Opalflex® / Lentiflex®
 Steelflex® / Goldflex® / Copperflex®
 WITH: Magnetic System®

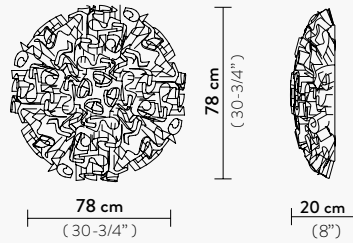

COLOURS:



VELI CEILING-WALL M

2 X 12W LED Filament Bulbs E27/E26
 MADE OF: Opalflex® / Lentiflex®
 Steelflex® / Goldflex® / Copperflex®
 WITH: Magnetic System®

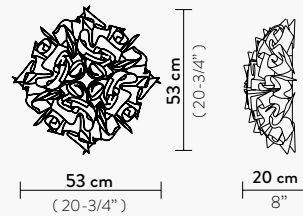

COLOURS:



VELI CEILING-WALL MINI

2 X 5W LED Filament Bulbs E14/E12
 MADE OF: Opalflex® / Lentiflex®
 Steelflex® / Goldflex® / Copperflex®
 WITH: Magnetic System®

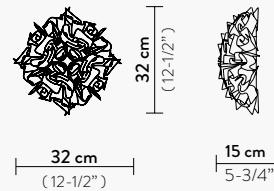

COLOURS:

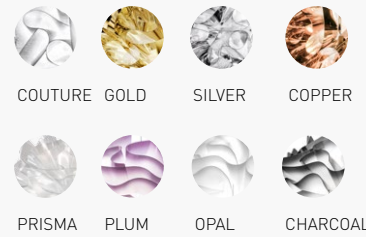

VELI SUSPENSION FOLIAGE L

4 X 12W LED Filament Bulbs E27/E26
 MADE OF: Opalflex®
 WITH: Magnetic System®
 Couture with Red wrapped cable,
 available also with transparent cable



COLOURS:



VELI SUSPENSION FOLIAGE

2 X 12W LED Filament Bulbs E27/E26
 MADE OF: Opalflex®
 WITH: Magnetic System®
 Couture with Red wrapped cable,
 available also with transparent cable

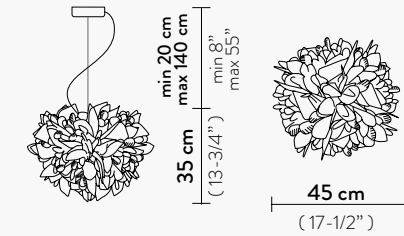

VELI TABLE

1 X 6W LED Filament Bulbs E14/E12
 MADE OF: Opalflex® / Metacrylate base
 WITH: Magnetic System®

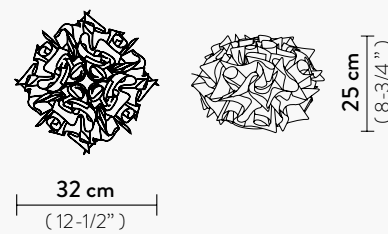

COLOURS:

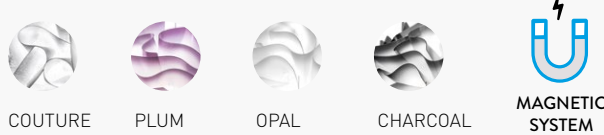

VELI 7

9 X 12W LED Filament Bulbs E27/E26
 MADE OF: Opalflex®
 Foliage and Couture Version with transparent wire

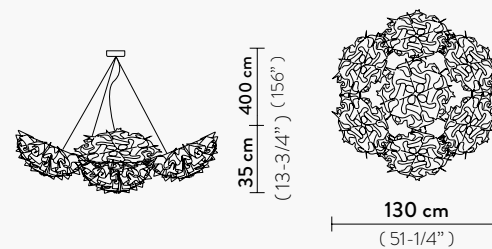

COLOURS:

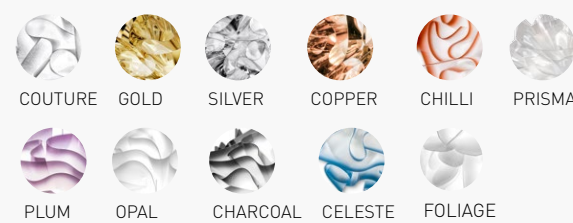

VELI CEILING-WALL FOLIAGE L

3 X 12W LED Filament Bulbs E27/E26
 MADE OF: Opalflex®
 WITH: Magnetic System®

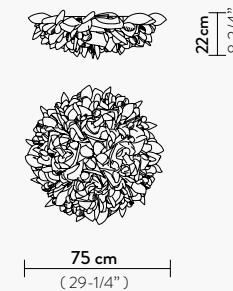

COLOURS:



VELI CEILING-WALL FOLIAGE M

2 X 12W LED Filament Bulbs E27/E26
 MADE OF: Opalflex®
 WITH: Magnetic System®

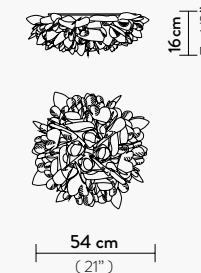

COLOURS:



VELI CEILING-WALL FOLIAGE MINI

2 X 5W LED Filament Bulbs E14/E12
 MADE OF: Opalflex®
 WITH: Magnetic System®

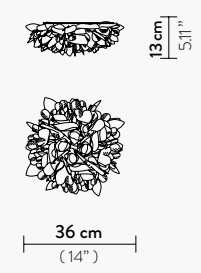

COLOURS:



VELI TABLE FOLIAGE

1 X 6W LED Filament Bulbs E14/E12
 MADE OF: Opalflex® / Metacrylate base
 WITH: Magnetic System®

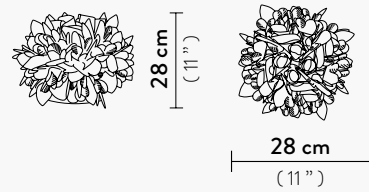

COLOURS:



FOLIAGE



MAGNETIC SYSTEM

VENTI TABLE

1 X 6W LED Filament Bulb E14/E12
 MADE OF: Opalflex®
 WITH: Aluminum profiles

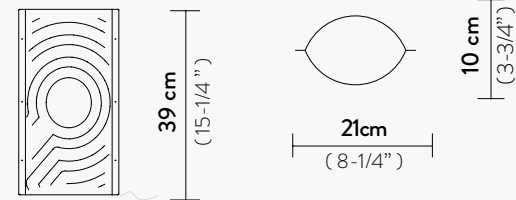

COLOURS:



WHITE

VENTI FLOOR

3 X 12W LED Filament Bulbs E27/E26
 MADE OF: Opalflex®
 WITH: Dimmer - Aluminum profiles

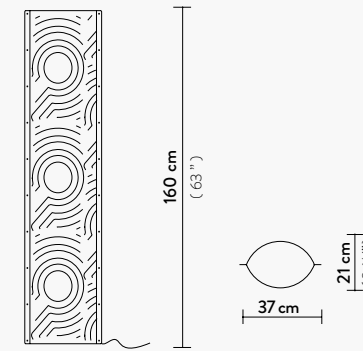

COLOURS:



WHITE

WOODY SUSPENSION

1 X 12W LED Filament Bulb E27/E26
 MADE OF: Polycarbonate / Wood

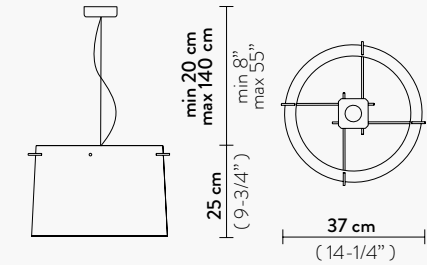

COLOURS:



WHITE



ORANGE



PURPLE



BLUE

VENTI CEILING/WALL L

4 X 12W LED Filament Bulbs E27/E26
 MADE OF: Opalflex®
 WITH: Magnetic System®

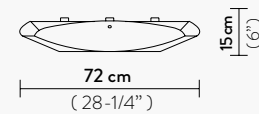

COLOURS:



WHITE

VENTI CEILING/WALL M

3 X 12W LED Filament Bulbs E27/E26
 MADE OF: Opalflex®
 WITH: Magnetic System®

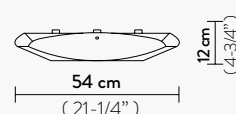

VENTI CEILING/WALL S

2 X 12W LED Filament Bulbs E27/E26
 MADE OF: Opalflex®
 WITH: Magnetic System®

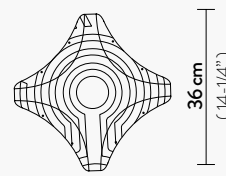
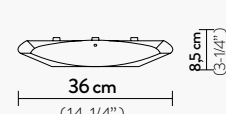

MAGNETIC SYSTEM

SLAMP'S HANDMADE APPROACH

MORE THAN 25 YEARS OF SUSTAINABLE MANUFACTURING



Every Slamp lamp is unique.
Unique because the ladies who "tailor light" don their white gloves and proudly bring a poetically original piece to life.

Ogni lampada Slamp è unica.
Unica perché allestita in un Atelier dove ogni giorno le Sarte della Luce, indossati i loro guanti bianchi, sono orgogliose di mettere al mondo un capo che si distingue per poetica e originalità.

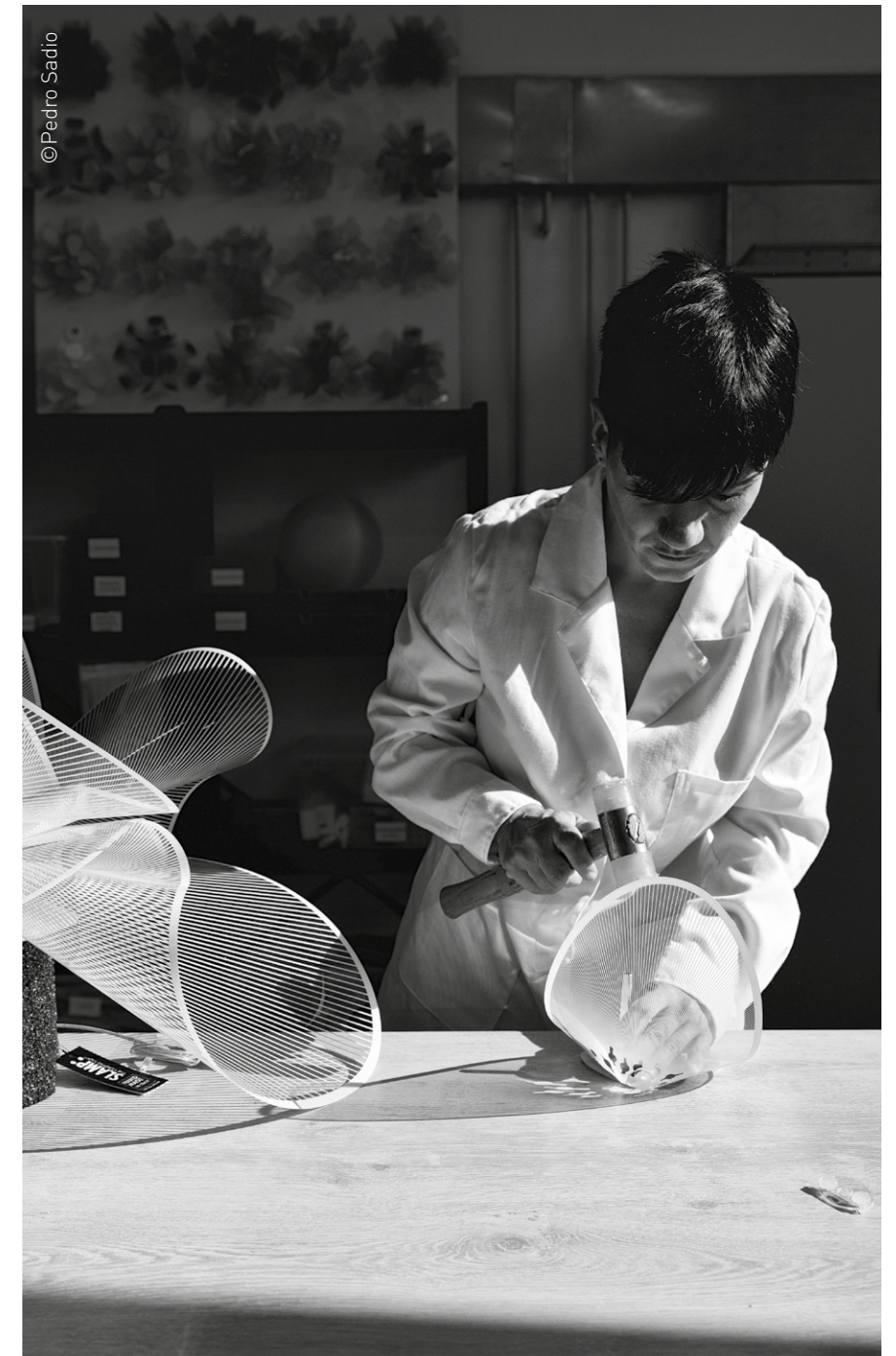

PLAY VIDEO

SLAMP
THE LEADING LIGHT

ALL SLAMP PRODUCTS ARE PRODUCED AND ASSEMBLED IN ITALY

WWW.SLAMP.IT

PRODUCTS ARE PATENTED THROUGHOUT THE WORLD AND CONFORM TO THE LEADING ELECTRICAL SAFETY STANDARDS:

CE IP 20               CB REPORT AVAILABLE ON REQUEST

SLAMP S.p.A.
reserves the right to modify price list and/or products without notice
in the event of commercial conditions rendering this necessary.
Slight differences of colour in some products in this catalogue
are due to the processes involved in printing.

SLAMP S.p.A.
si riserva il diritto di apportare modifiche al listino e ai prodotti senza
alcun preavviso, qualora le condizioni commerciali lo rendessero
necessario. Difficoltà di colore di alcuni prodotti sul presente
catalogo sono dovute a processi di stampa.



VISIONARY
ADAPTABLE
SENSUAL
MYSTERIOUS
INNOVATIVE
ACCESSIBLE
RELIABLE
ASPIRATIONAL
ORIGINAL
RESOURCEFUL
EXPERIMENTAL
SUGGESTIVE
HANDMADE

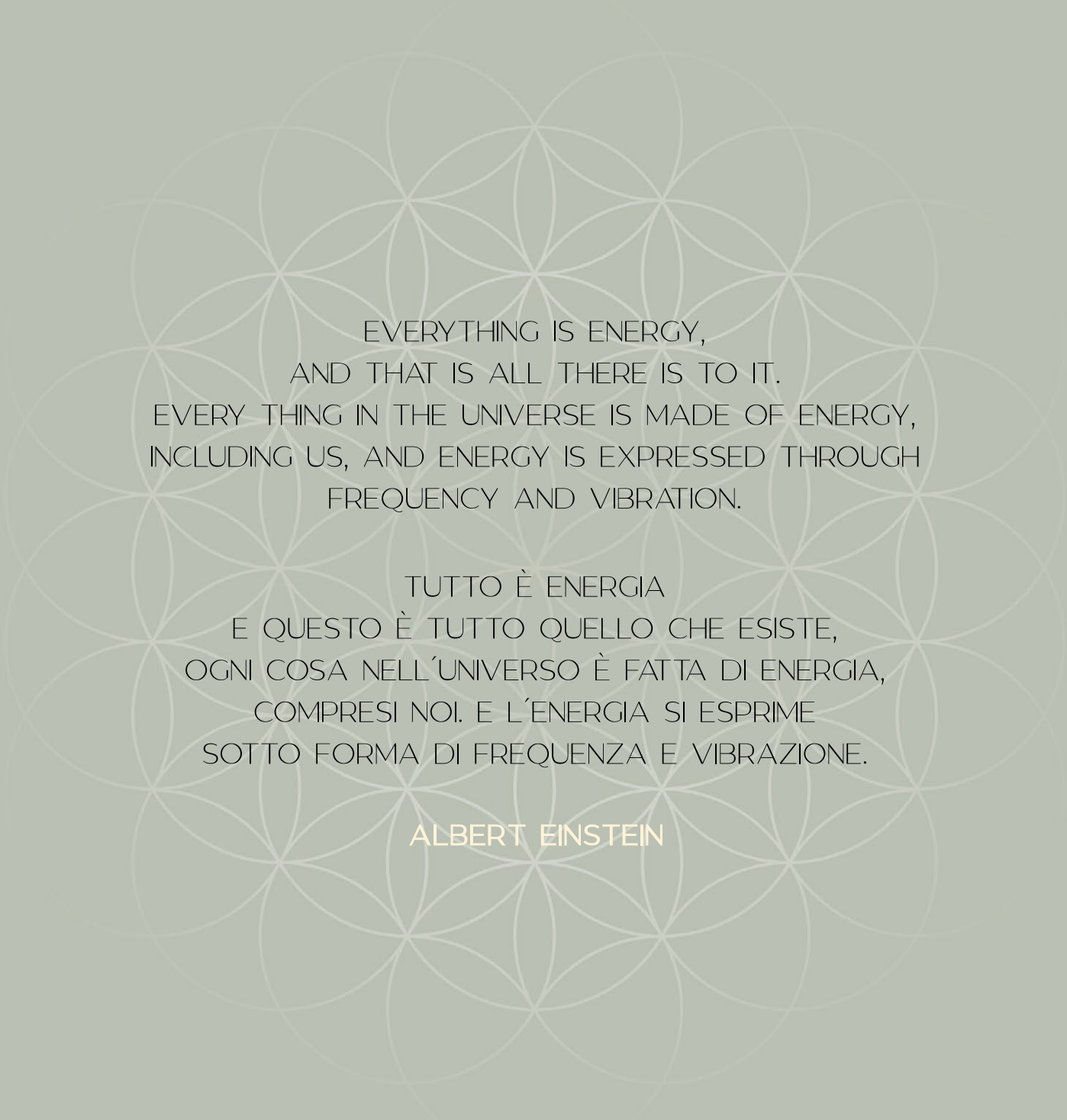

EVERYTHING IS ENERGY,
AND THAT IS ALL THERE IS TO IT.
EVERY THING IN THE UNIVERSE IS MADE OF ENERGY,
INCLUDING US, AND ENERGY IS EXPRESSED THROUGH
FREQUENCY AND VIBRATION.

TUTTO È ENERGIA
E QUESTO È TUTTO QUELLO CHE ESISTE,
OGNI COSA NELL'UNIVERSO È FATTA DI ENERGIA,
COMPRESI NOI. E L'ENERGIA SI ESPRIME
SOTTO FORMA DI FREQUENZA E VIBRAZIONE.

ALBERT EINSTEIN

HANDMADE IN ITALY

SLAMP:
THE LEADING LIGHT